



PDi TV Box

INSTALLATION & USER MANUAL

Document Number: PD196-474R2

For model number PDi-TVb7000

This manual is intended for qualified installers and hospital IT staff.
Please read the safety and operating instructions and retain this document for future reference.

TV Box Documents

The PDi TV Box comes with the following manuals. Please scan the QR codes below to access these resources.

Instruction Manual (This document): Safety information, TV Box installation, and Setup guidelines

GENiO Guide: Instructions on setting up GENiO, PDi's cloud-based TV control

IPTV Guide: IPTV setup guidelines



1. TV Box Manuals



2. PDi Document Library

Pre-install checklist

Included in your package:

- Mounting plate for the TV Box
- HDMI cable
- Power cable

The following important accessories are not included in your package and may be ordered separately:

- PDi Programming Remote
- Approved Wall Mount Bracket for Your Display
- Mounting Screws and Wall Anchors
- Coaxial RF Cable
- ¼" Pillow Speaker Jumper Cable
- Ethernet Cable (if network connection required)

Please have all necessary items on hand before installation.

Copyright, Trademarks

©2026 PDi Communication Systems, Inc. All rights reserved. PDi® and medTV® are registered trademarks of PDi Communication Systems, Inc. Manufactured under license from Dolby Laboratories. Dolby, Dolby Audio, and the double-D symbol are trademarks of Dolby Laboratories Licensing Corporation. The terms HDMI, HDMI High-Definition Multimedia Interface, and the HDMI Logo are trademarks or registered trademarks of HDMI Licensing Administrator, Inc. Product logos, brands and other trademarks displayed within PDi's products are the property of their respective trademark holders, who are not affiliated with, endorsing, or sponsoring PDi Communication Systems, Inc. or our product.

Table of Contents

IMPORTANT SAFETY INSTRUCTIONS4

IMPORTANT SAFETY INSTRUCTIONS5

IMPORTANT SAFETY INSTRUCTIONS (FRENCH)6

PART I: CONNECTIONS & INSTALLATION7

CABLING AND WIRING REQUIREMENTS7

Coax Cable Specifications7

Coax Connection7

Across-Room Wiring7

INSTALLING THE TV BOX9

Installing a PDi TV Box on TV/monitor9

Installing a PDi TV Box on wall9

PART II: CONFIGURING THE TV BOX11

REMOTE CONTROLS & KEYBOARDS11

Programming Remote Control11

Pillow Speakers11

SET-UP WIZARD12

Optional USB Cloning12

Wi-Fi Setup12

Initial Power On– No GENiO12

IPTV and RF12

Initial Power On – With GENiO12

Network Requirements12

Reset Configuration/ Connect to GENiO13

POPULAR IPTV SETTINGS13

IPTV Aspect Ratio13

IPTV Sleep Timer13

IPTV App Settings and Channel Configurator13

POPULAR SYSTEM SETTINGS14

Network Settings14

Wireless Audio15

Volume15

Pillow Speaker Only15

Security and Privacy15

Date & Time15

App Permissions15

UPDATING FIRMWARE16

Firmware Update – OTA16

Firmware Update – USB16

Firmware Update – GENiO16

FACTORY RESET/ SYSTEM RECOVERY16

USB CLONING17

672M0UE LG SERIES TV SETTINGS FOR HDMI CEC17

TROUBLESHOOTING TIPS18

LIMITED WARRANTY18

IMPORTANT SAFETY INSTRUCTIONS



This symbol indicates that dangerous voltage constituting a risk of electric shock is present within this unit.



This symbol indicates that there are important operating and maintenance instructions in the literature accompanying this unit.



CAUTION

RISK OF ELECTRIC SHOCK,
DO NOT OPEN!



CAUTION: TO REDUCE THE RISK OF ELECTRIC SHOCK, DO NOT REMOVE COVER. NO USER SERVICEABLE PARTS INSIDE. REFER SERVICING TO QUALIFIED SERVICE PERSONNEL



Overhead Falling Hazard

TV Box can pose a striking hazard when mounted at an elevated position. Use only PDi mounting brackets, support arms, and appropriate hardware to assure TV and TV Box will not fall from the mounted position. Failure to do so may cause injury or death.



Rain and Moisture

WARNING: To avoid the hazards of fire or electrical shock, DO NOT expose this TV Box to rain or moisture.



Oxygen Environment

WARNING: Do not use in any oxygen tent or oxygen chamber. Such use may cause a fire hazard.



Wet Locations

Do not use this TV Box near water. TV Box shall not be exposed to dripping or splashing and no objects filled with liquids, such as vases, shall be placed on the TV Box.

Note to Cable TV Installer

Example of Antenna Grounding as per NEC - National Electrical Code

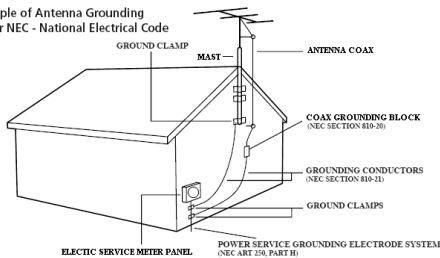

This reminder is provided to call the cable TV system installer's attention to Article 820-40 of the National Electrical Code. The code provides

guidelines for proper grounding and specifies that the cable ground shall be connected to the grounding system of the building, as close to the point of the cable entry as practical. Canadian installations shall be properly grounded in accordance with the Canadian Electrical Code, Part 1.

FCC

This equipment has been tested and found to comply with the limits for a Class A digital device, pursuant to part 15 of the FCC Rules. These limits are designed to provide reasonable protection against harmful interference when the equipment is operated in residential or commercial installation. If this equipment does

cause harmful interference to radio or television reception, which can be determined by turning the equipment off and on, the user is encouraged to try to correct the interference by one or more of the following measures:

- Reorient or relocate the receiving antenna.
- Increase the separation between the equipment and receiver.
- Connect the equipment into an outlet on a circuit different from that to which the receiver is connected.
- Consult the dealer or an experienced radio/TV technician for help.

Cleaning and Disinfection

Clean the exterior of this TV Box by removing dust with a lint-free cloth. Spot test a new disinfectant by test cleaning a non-obvious small spot on the TV Box's surface. PDi recommends using a premoistened disinfectant cloth, like PD600-001 Super Sani-Cloth or similar, or spraying cleaner onto a dry cloth and then wiping the unit. Specific recommendations can be found at www.pdiarm.com. CAUTION: To avoid damage to the TV Box, do not use abrasive or chemical cleaning agents.

Copyright, Trademarks

©2026 PDi Communication Systems, Inc. All rights reserved. PDi® and medTV® are registered trademarks of PDi Communication Systems, Inc. Manufactured under license from Dolby Laboratories. Dolby, Dolby Audio, and the double-D symbol are trademarks of Dolby Laboratories Licensing Corporation. The terms HDMI, HDMI High-Definition Multimedia Interface, and the HDMI Logo are trademarks or registered trademarks of HDMI Licensing Administrator, Inc. Product logos, brands and other trademarks displayed within PDi's products are the property of their respective trademark holders, who are not affiliated with, endorsing, or sponsoring PDi Communication Systems, Inc. or our products.

Underwriters Laboratories



This product is a specialized TV Box and should be installed to National Electrical Code specifications. This device is safety tested and listed by the Underwriters Laboratories as a product suitable for use in healthcare facilities in both the United States and Canada.

IMPORTANT SAFETY INSTRUCTIONS

THIS INSTALLATION SHOULD BE MADE BY A QUALIFIED SERVICE PERSON AND SHOULD CONFORM TO ALL LOCAL CODES. READ AND FOLLOW THE SAFETY INSTRUCTIONS BEFORE ATTEMPTING THIS INSTALLATION.

1. Read these Instructions – All the safety and operating instructions should be read before the product is operated.
2. Keep these Instructions – The safety and operating instructions should be retained for future reference.
3. Heed all warnings – All warnings on the product and in the operating instructions should be adhered to.
4. Follow all instructions – All warnings on the product and in the operating instructions should be followed.
5. Do not use this apparatus near water – for example, near a bathtub, wash bowl, in a wet basement; or near a swimming pool; and the like.
6. Cleaning – Please see specific recommendations under “Cleaning and Disinfection” on previous page.
7. Do not block any ventilation openings. Install in accordance with the manufacturer’s instructions. The openings should never be blocked by placing the product on a bed, sofa, rug, or other similar surface.
8. Do not install near any heat sources such as radiators, heat registers, stoves, or other apparatus (including amplifiers) that produce heat.
9. DO NOT defeat the safety purpose of the polarized or grounding-type plug. This product is equipped with a three-wire grounding-type plug, a plug having a third (grounding) pin. This plug will only fit into a grounding-type power outlet. This is a safety feature. If you are unable to insert the plug into the outlet, contact your electrician to replace your obsolete outlet.
10. Protect the power cord from being walked on or pinched particularly at plugs, convenience receptacles, and the point where they exit from the product.
11. Attachments only use attachments/accessories specified by the manufacturer.
12. Refer all servicing to qualified service personnel. Servicing is required when the apparatus has been damaged in any way, such as power-supply cord or plug is damaged, liquid has been spilled or objects have fallen into the apparatus, the apparatus has been exposed to rain or moisture, does not operate normally, or has been dropped.
13. Power Sources – This product should be operated only from the type of power source indicated on the marking label. If you are not sure of the type of power supply to your facility, consult your product dealer or local power company. For products intended to operate from battery power, or other sources, refer to the operating instructions.
14. Oxygen Environment – Do not use in an oxygen tent or oxygen chamber. Such use may cause a fire hazard.
15. Lightning – For added protection for this product during a lightning storm, or when it is left unattended and unused for extended periods of time, unplug it from the wall outlet and disconnect the antenna or cable system. This will prevent damage to the product due to lightning and power-line surges.
16. Servicing – Do not attempt to service this product yourself as opening or removing covers may expose you to dangerous voltage or other hazards. Refer all servicing to qualified service personnel.

IMPORTANT SAFETY INSTRUCTIONS (FRENCH)

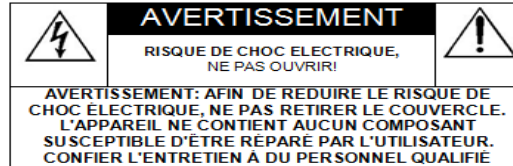
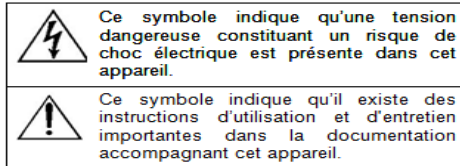

Danger chute d'objets



AVERTISSEMENT: Afin d'éviter toute blessure, cet appareil doit être solidement fixé au sol/mur conformément aux instructions d'installation. Les décodeurs peuvent présenter un risque de heurt

lorsqu'elles sont montées en position élevée. Utiliser uniquement des supports de montage, des bras de support et le matériel approprié de PDi afin d'assurer que la décodeur ne tombe pas de sa position de montage. Le non-respect de ces instructions peut causer des blessures ou la mort.

Pluie et humidité



AVERTISSEMENT: Afin d'éviter les risques d'incendie ou de choc électrique, NE PAS exposer cette décodeur à la pluie ou à l'humidité ou l'utiliser dans un endroit humide.

Environnement d'oxygène



AVERTISSEMENT: Ne pas utiliser dans une tente à oxygène ou chambre à oxygène. Une telle utilisation peut causer un risque d'incendie.

CONSIGNES DE SÉCURITÉ IMPORTANTES
CETTE INSTALLATION DOIT ÊTRE EFFECTUÉE PAR UN TECHNICIEN QUALIFIÉ ET DOIT ÊTRE CONFORME À TOUS LES CODES LOCAUX. LIRE ET SUIVRE LES CONSIGNES DE SÉCURITÉ AVANT DE PROCÉDER À L'INSTALLATION.

- Lire ces instructions. Toutes les consignes de sécurité et d'utilisation doivent être lues avant d'utiliser le produit.
- Conserver ces instructions. Les consignes de sécurité et d'utilisation doivent être conservées pour référence future.
- Respecter tous les avertissements. Tous les avertissements sur le produit et dans les consignes d'utilisation doivent être respectés.
- Suivre toutes les instructions. Tous les avertissements sur le produit et dans les consignes d'utilisation doivent être suivis.
- Ne pas utiliser cet appareil près de l'eau - par exemple près d'une baignoire, d'un lavabo, dans un sous-sol humide, ou près d'une piscine ou similaire.
- Veillez voir les recommandations sous "Nettoyage et Désinfection" à la Page précédente.
- Ne pas obstruer les ouvertures de ventilation. Installer conformément aux instructions du fabricant. Les ouvertures ne doivent jamais être obstruées en plaçant le produit sur un lit, un canapé, un tapis ou toute autre surface similaire.
- NE PAS installer près de sources de chaleur telles que radiateurs, registres de chaleur, poêles ou tout autre appareil (y compris les amplificateurs) qui produit de la chaleur.
- NE PAS neutraliser le dispositif de sécurité de la fiche polarisée ou de terre. Ce produit est équipé d'une prise de terre à trois fils, une fiche ayant une troisième broche (mise à la terre). Cette fiche ne peut s'insérer que dans une prise de courant avec mise à la terre. Il s'agit d'une caractéristique de sécurité. Si vous êtes incapable d'insérer la fiche dans la prise, contacter votre électricien pour remplacer votre prise obsolète.
- Protéger le cordon d'alimentation pour qu'il ne soit pas piétiné ni pincé, en particulier au niveau des fiches, des prises de courant et au point de sortie de l'appareil.
- Accessoires - Utiliser uniquement les attaches/accessoires recommandés par le fabricant.
- Confier toute réparation à un personnel de service qualifié. Des réparations sont nécessaires si l'appareil est endommagé d'une façon quelconque, par exemple : cordon ou prise d'alimentation endommagé, liquide renversé ou des objets sont tombés dans l'appareil, l'appareil a été exposé à la pluie ou à l'humidité, ne fonctionne pas normalement ou s'il est tombé.
- Sources d'alimentation - Ce produit doit être utilisé uniquement à partir du type de source d'alimentation indiqué sur l'étiquette. Si vous n'êtes pas sûr sur le type d'alimentation de votre domicile, consultez le détaillant de votre produit ou la compagnie d'électricité locale. Pour les produits proposés de fonctionner par piles, ou autres sources d'alimentation, reportez-vous aux consignes d'utilisation.
- Environnement d'oxygène - Ne pas utiliser sous une tente à oxygène ou chambre à oxygène. Une telle utilisation peut causer un risque d'incendie.
- Foudre - Pour une protection supplémentaire pour ce produit lors d'un orage, ou lorsqu'il est laissé sans surveillance et inutilisé pendant de longues périodes de temps, le débrancher de la prise murale et déconnecter l'antenne ou le système de câble. Cela permettra d'éviter tout dommage à l'appareil causé par la foudre et par les surtensions des lignes électriques.
- Entretien - N'essayez pas de réparer ce produit vous-même car l'ouverture ou le retrait des couvercles peut vous exposer à une tension dangereuse ou à d'autres dangers. Confiez toutes les réparations à un technicien qualifié.

PART I: CONNECTIONS & INSTALLATION

This section is for installers

CABLING AND WIRING REQUIREMENTS

TV Box front view

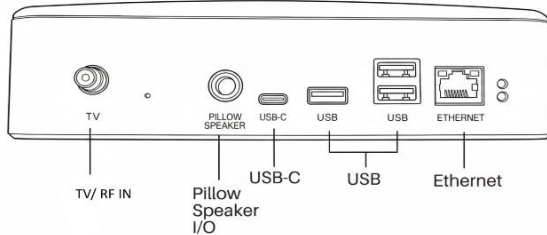

Side view

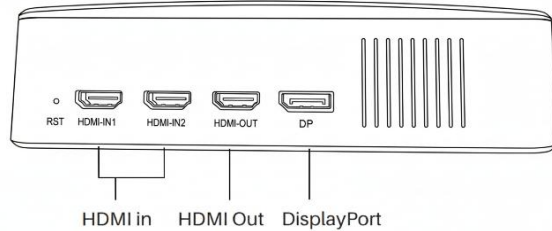

Rear view

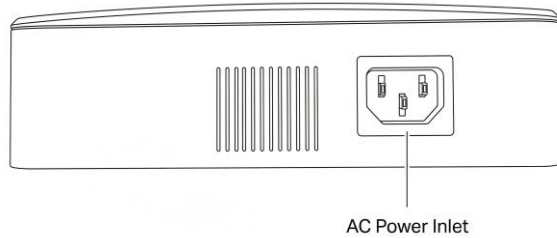

Across-Room Wiring

NOTE: A jumper cable (shown below) is NOT supplied with the TV Box and must be ordered separately.

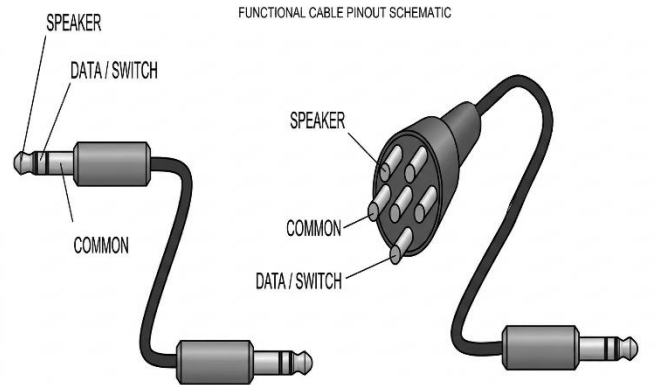

Coax Cable Specifications

Due to long coax cable runs encountered in hospital installations, coax cable employing a solid copper center conductor and copper shield may be used, although this is not required.

Coax Connection

Do not overtighten coax cable when connecting it to the RF connector. Tighten to no more than 8 in-lbs. of torque. If a proper torque wrench is unavailable, finger tighten until the nut on the cable does not move easily, then tighten no more than an additional 1/8 turn.

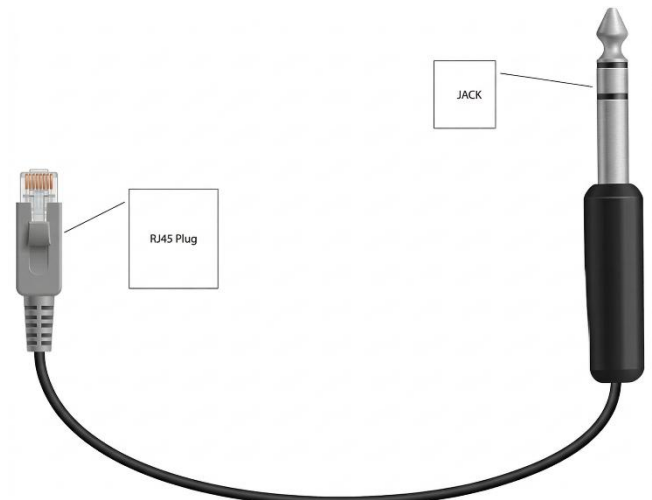

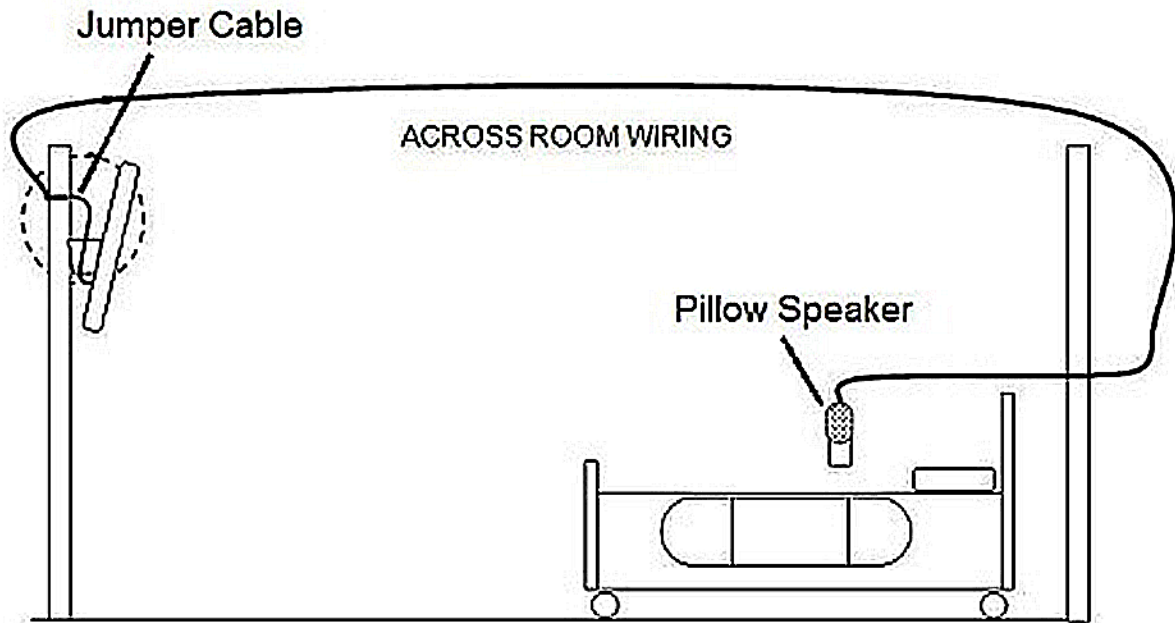
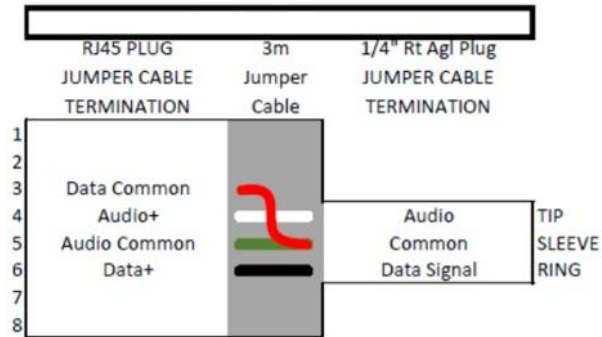
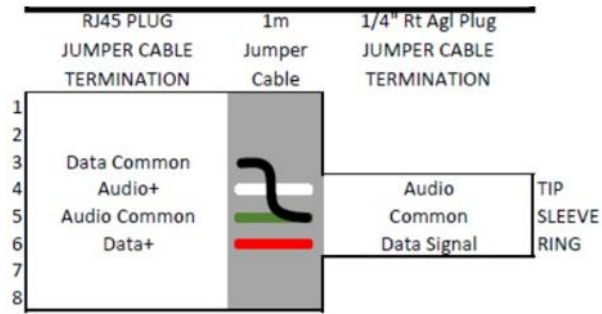

INSTALLING THE TV BOX

Installing a PDi TV Box on TV/monitor

Step 1

1. Install your articulating mount behind your TV/monitor. NOTE: Skip this step if you already have a TV with an installed mount.

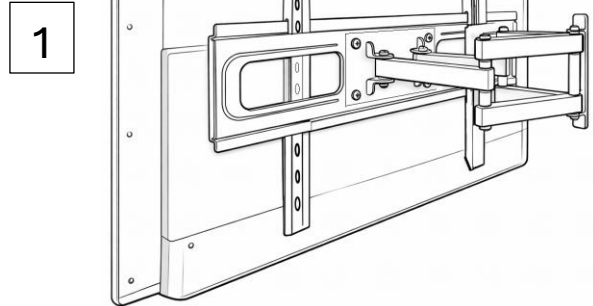

Step 2

2. Position the Accessory Mounting Bracket on the underside of the TV Box. Align the four holes on the bracket with the four threaded holes on the box.
3. Fasten the bracket to the TV Box by driving the four M4 pan-head screws into the threaded holes. Ensure the plate is firmly attached and does not wobble. See diagrams 2 and 3.

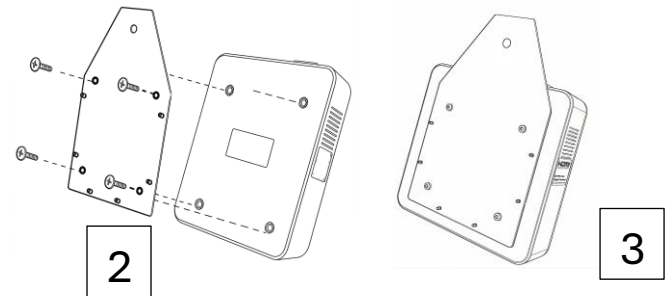

Step 3

4. Turn off and unplug the TV.
5. Carefully pull the TV away from the wall using the articulating mount.
6. Identify one VESA mounting hole you would like to use to install the TV Box.
7. Remove the VESA screw attached to that mounting hole.
8. Align the hole in the accessory/ secondary mount bracket with your chosen VESA hole.
9. Re-insert the screw through:
 - The accessory mount bracket
 - The wall mount plate
 - Into the TV
10. If the screw feels loose or is too small for the clearance hole, use the appropriate washers to ensure a snug fit.
11. Tighten the screw securely without overtightening.

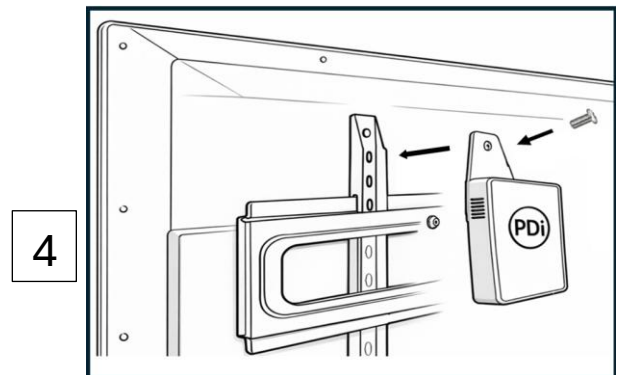

Step 4

12. Connect the HDMI, power, and Ethernet cables.
13. Plug the TV and TV Box back into power and turn on the TV.
14. Verify the TV Box powers on and displays correctly.
15. Gently push the TV back toward the wall.
16. Confirm the TV Box remains secure.

Installing a PDi TV Box on wall

1. Follow steps 1, 2, and 3 above.
2. Follow recommended installation procedure for your anchoring hardware.

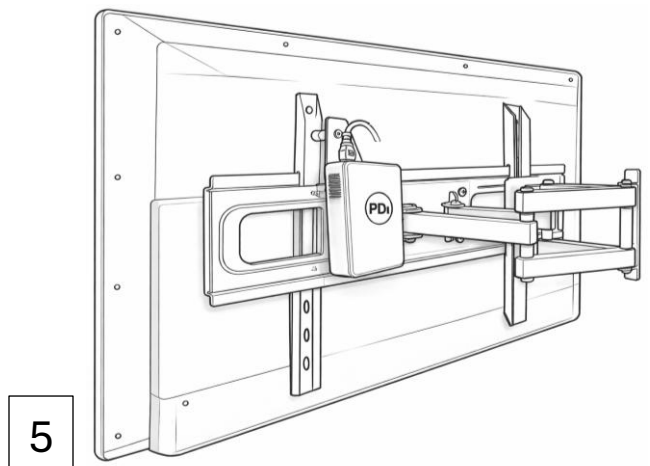

Installer Section Complete

At this point:

- ✓ TV Box is safely mounted
- ✓ Cables are connected
- ✓ Power verified
- ✓ Boot screen confirmed

**Further configuration must be performed by
authorized Hospital IT personnel.**

Please Refer Part II to Hospital IT staff.

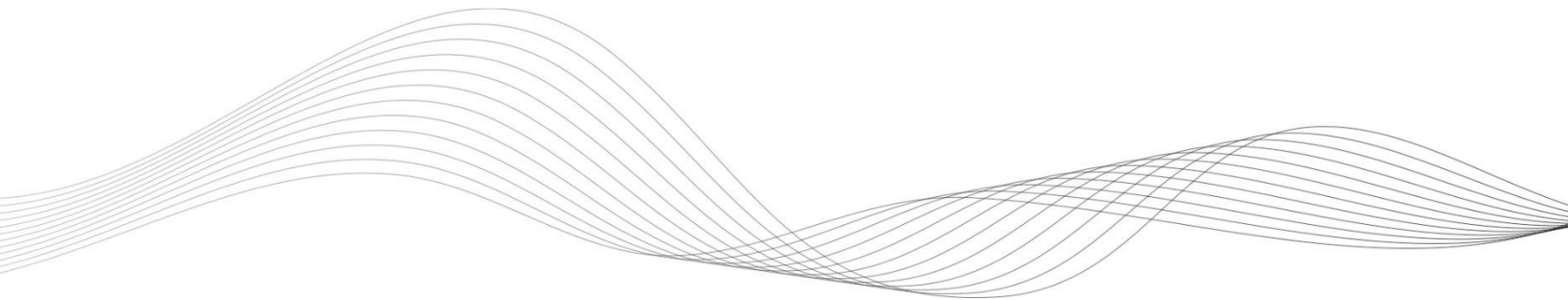

PART II: CONFIGURING THE TV BOX

This section is for hospital IT staff

REMOTE CONTROLS & KEYBOARDS

You can use the PD108-520 programming remote to complete all setup tasks for the TV Box. You will have to connect a 1/4" IR receiver jack (PD106-1024) to the TV Box to enable this operation. This programming remote will operate any PDi TV/ TV Box regardless of the product's Bed A/B/C/D setting. **NOTE:** Because these remotes have the TV SETUP button to gain full access to the TV's menus, patients should not have access to them. PDi offers other remotes for patient use.

Programming Remote Control

Power, setup, and the directional buttons will be the main buttons used on the programming remote. See PDi document PD196-446 for additional information on the PD108-520 remote.

Alternative ways to configure your TV Box include using a keyboard and mouse or a pillow speaker. However, configuring with a pillow speaker is not ideal.

Pillow Speakers

This TV Box is designed for 5V pillow speaker voltage and works with a digital pillow speaker that generates digital-style control codes. The TV Box is compatible with universal pillow speaker recognition code set.

To get full use out of all of the features available to patients on PDi TV Boxes, PDi recommends selecting a pillow speaker with the following buttons: **HOME, BACK, NAVIGATION ARROWS, and OK/SELECT.**

The table below details the function of the main buttons on the programming remote.

Label	Function
1	Turn selected device on and off
2	Access menus
3	Navigate on-screen menus and adjust settings

Main buttons on pillow speakers

Label	Function
4	Exit to main system dashboard
5	Return to the previous screen or menu level

A. Programming remote control

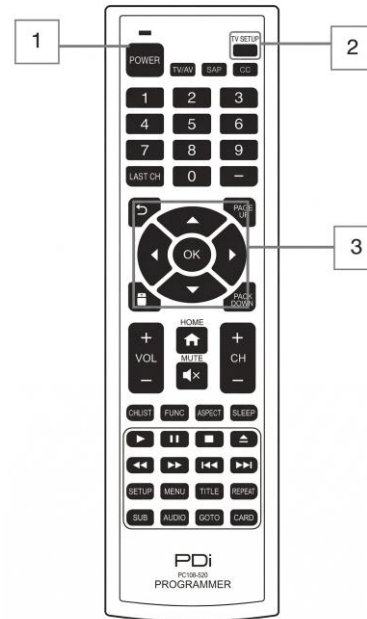

B. Keyboard and mouse



C. Pillow speakers

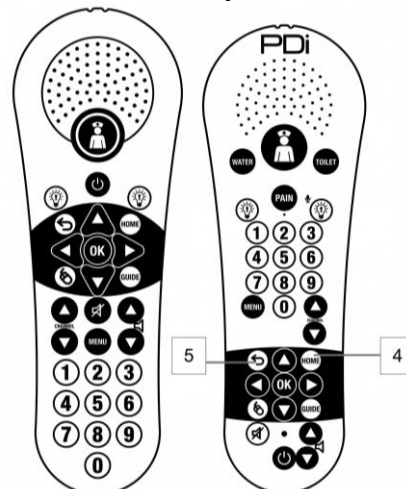

SET-UP WIZARD

The first time the TV Box is powered up, you will be prompted to use the Set-Up Wizard to help with initial set up. Follow the onscreen prompts to navigate through the menus.

Optional USB Cloning

If you have already configured a TV Box to the desired settings and saved a clone file to USB, you can load those settings onto other TV Boxes through this menu.



Wi-Fi Setup



Initial Power On– No GENiO



If you do not have a GENiO project ID, press the OK button on the program remote. You will see two configuration options. **Select IPTV and press the OK button.**

IPTV and RF

For information on IPTV or RF setup and use, see PDi Document PD196-460, IPTV App User Guide.

Initial Power On – With GENiO

Upon initial power up, you will see the screen below.



If you have subscribed to GENiO and been assigned a project ID:

1. To connect your device to GENiO, you must first provide internet access to the device. If the device cannot connect to GENiO, you will see this message: "There is no project associated with this identity code." **NOTE:** A hardwired connection is PDi's recommended method of providing internet connectivity. Do NOT connect your devices to a network that uses captive portal (see Network Requirements section below).
2. **Hardwired internet:** Simply connect the ethernet cable to the TV Box.
3. **WiFi internet:** Follow the onscreen prompts in the set-up wizard Wi-Fi Selection section.
4. Enter your five-digit GENiO project ID. If a valid project ID has been entered, a message will appear with the project name. Press the OK button to proceed.
5. Select your department to be able to do different configurations in GENiO.
6. (optional) Enter the location of the device. This will populate into GENiO to make the device easier to locate and manage within GENiO.
7. Press the OK button to finish.

Network Requirements

See PDi Document PD196-462 for network requirements for ensuring the PDi device will operate correctly on the IP network.

Reset Configuration/ Connect to GENiO

This step lets you reset the TV Box's configuration or connect to GENiO. You will need the keyboard and mouse to perform parts of this operation.

1. From the TV home screen, switch the program remote to mouse mode by pressing the mouse button on the remote. You will see a message on the TV indicating the TV Box UI is now in mouse mode.
2. With the navigation arrows, move the mouse to the medTV logo (or other logo if the TV has been previously customized through GENiO) in the top left corner of the screen. Press and hold **the left-click key on the keyboard and mouse** until a password entry window appears.
3. Enter the default password 45066. NOTE: The TV will still be in mouse mode. The numbers can be entered with the keypad on the remote but to select OK, you will need to navigate the mouse cursor to the OK button. Alternatively, you can put the TV back in keyboard mode by pressing the mouse button on the remote.
4. The Device Management Menu below will appear. With the TV in keyboard mode, press 2 on the remote to reconfigure the device per the set-up wizard instructions above.



POPULAR IPTV SETTINGS

IPTV Aspect Ratio

1. On the Homepage, press 1 on the programming remote to go to CHANNEL.
2. Select FEATURES and choose ASPECT RATIO.
3. Choose preferred option.



IPTV Sleep Timer

1. On the Homepage, press 1 on the programming remote to go to CHANNEL.
2. Select FEATURES and choose SLEEP TIMER.
3. Choose preferred option.

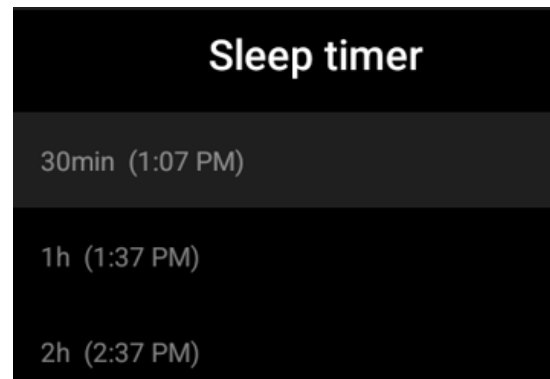

IPTV App Settings and Channel Configurator

1. Go to CHANNEL and select FEATURES.
2. Choose APP SETTINGS.
3. Enter the admin code (45066).
4. From the App settings page, you can access the CHANNEL CONFIGURATOR, VIDEO DEBUG MODE, ENABLE USB MEDIA PLAYER etc.

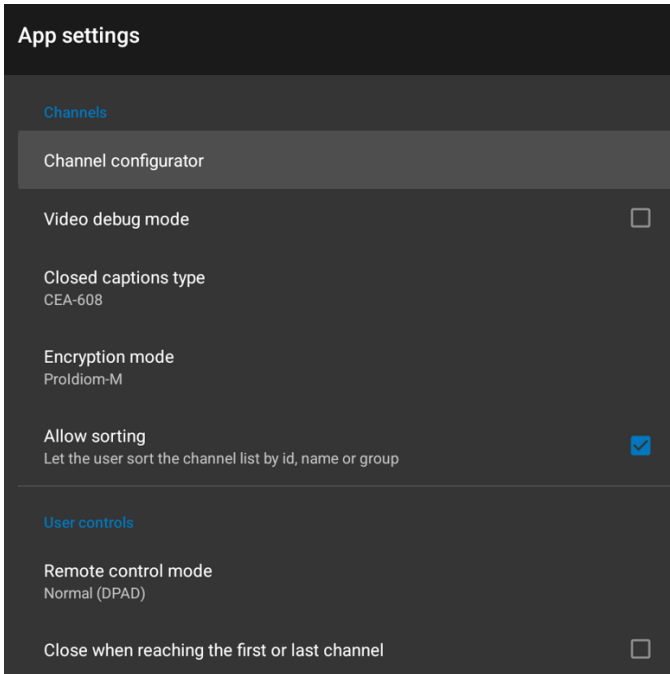

POPULAR SYSTEM SETTINGS Network Settings

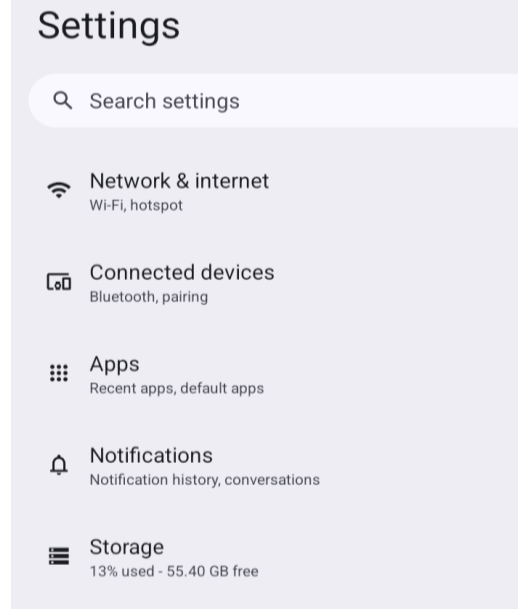

Adding HDMI as a Channel in the IPTV Menu

HDMI needs to be added as a channel to the IPTV menu. This will allow HDMI input sources to be used on the PDI-TV7000. With this enabled, all PDi source changing commands (either through CEC or API) should be functioning. Follow these steps to complete this step:

1. On the Homepage, press 1 on the programming remote to go to Channel.
2. Select FEATURES.
3. From the three options that appear, select the bottom option "APP SETTINGS."
4. Enter the passcode 45066.
5. Select the first option "CHANNEL CONFIGURATOR."
6. Select the "+" second from the top right.
7. Select the bottom option "ADD HDMI CHANNEL."
8. Include all information desired. If you do not want customers to be able to navigate to the HDMI source using the channel buttons, uncheck the "ENABLED" button.
9. Select the "SAVE" option in the bottom right hand of the pop-up menu.
10. Repeat steps 6-9 if you would like to add both HDMI sources.
11. Once all HDMI sources have been added, select the save icon in the top right hand of the screen and confirm that you would like to save the changes.

1. On the Homepage, press the TV SETUP button on the PDi programming remote to go into SETTINGS.
2. Enter the admin code (45066) when prompted.
3. Go to NETWORK AND INTERNET and configure network settings.

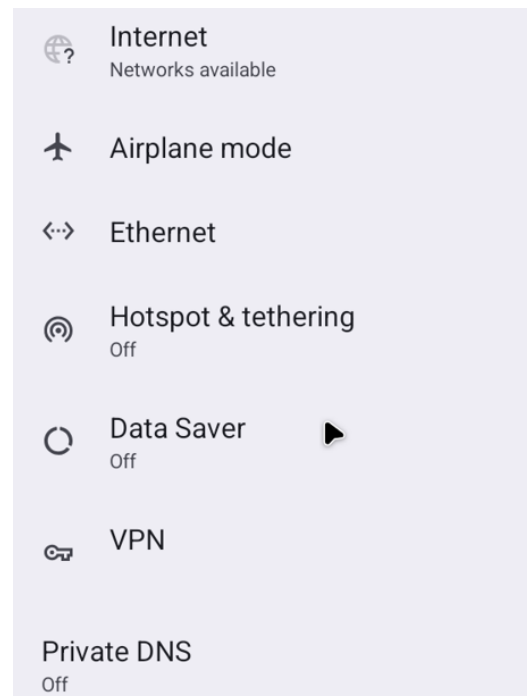

Wireless Audio

1. Go to **SETTINGS**.
2. Go to **CONNECTED DEVICES** and click on **PAIR NEW DEVICE**.
3. Choose your device from among the list and pair.

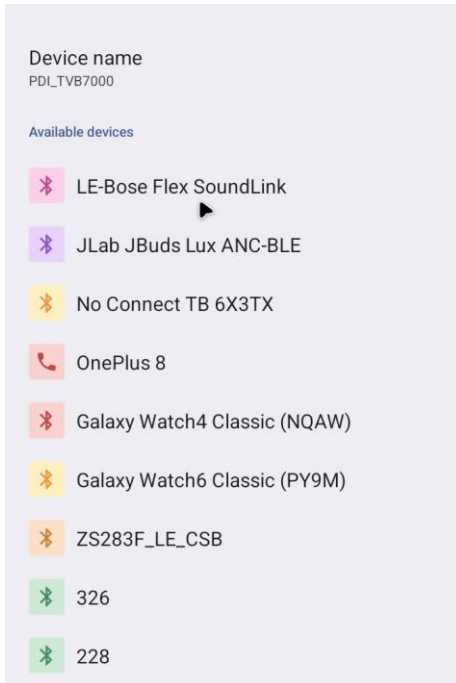

Security and Privacy

1. Go to **SETTINGS**.
2. Scroll down and select **SECURITY AND PRIVACY**.
3. Tweak **APP SECURITY, DEVICE LOCK, AND PRIVACY PERMISSIONS** as needed.

Date & Time

For GENiO to operate at full functionality, the TV Box must have access to the correct time from the network. By default, **SET TIME AUTOMATICALLY** is enabled. If you need to adjust this setting or change the time zone:

1. Go to **SETTINGS**.
2. Scroll to the bottom and select **SYSTEM**.
3. Choose **DATE & TIME**.
4. From there, you can modify the automatic time setting or update your time zone as needed.

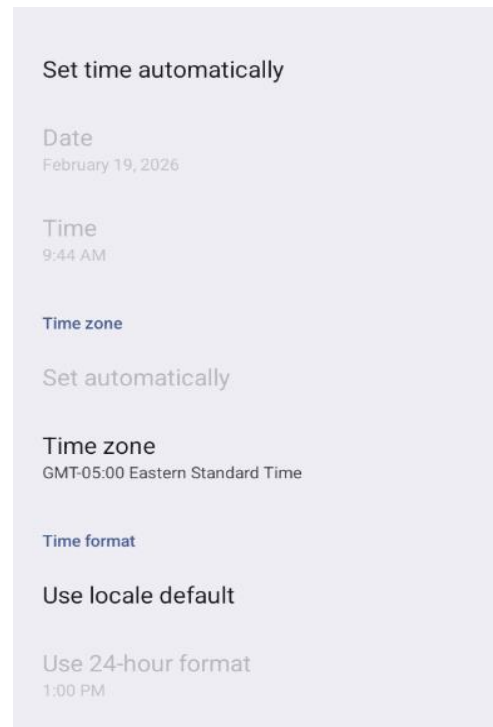

Volume

1. Go to **SETTINGS**.
2. Scroll down and click on **SOUND & VIBRATION**.
3. Adjust your volume as needed.

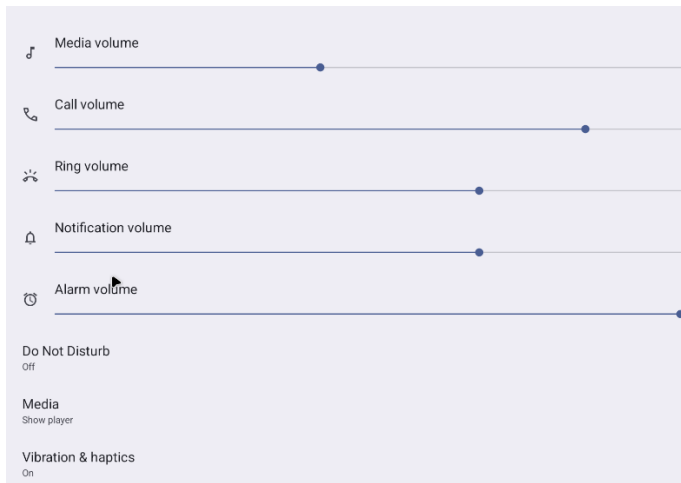

Pillow Speaker Only

This lets you choose whether or not to play sounds only through a pillow speaker.

1. Go to **SETTINGS**.
2. Scroll down and click on **SOUND & VIBRATION**.
3. Enable or disable **PILLOW SPEAKER ONLY**.

App Permissions

If apps have been installed on your TV Box through GENiO, you may need to enable the required permissions for them to work properly.

To enable app permissions:

1. Go to **SETTINGS**.
2. Select **APPS**.
3. Choose the app you want to adjust.
4. Select **PERMISSIONS** and enable the necessary options.

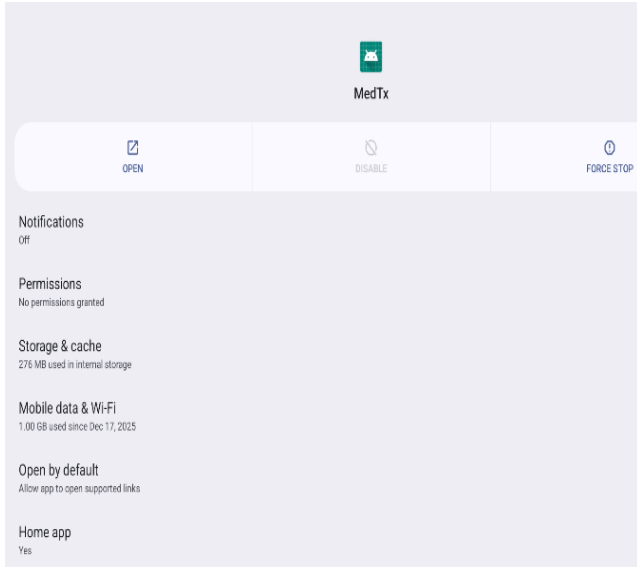

Repeat these steps for any other apps that require permission.

UPDATING FIRMWARE

Firmware Update – OTA

1. Go to SETTINGS.
2. Scroll to the bottom of the page and select SYSTEM.
3. Click on OTA SYSTEM UPDATE. The device will run a brief check for a system update or system upgrade.
4. If a system upgrade is available, click UPGRADE.

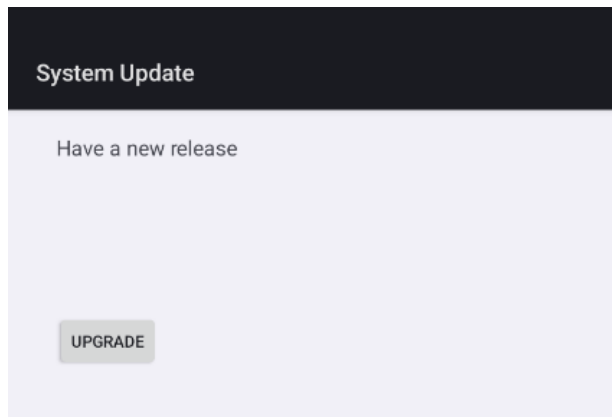

Firmware Update – USB

1. Contact PDi for a USB flash drive with a zipped firmware package.
2. Insert the USB flash drive into the USB-A port on the front of the TV box.
3. Go to SETTINGS and scroll down to SYSTEM.
4. Click on OTA SYSTEM UPDATES. The TV Box will automatically detect the firmware file on the attached USB drive (if the firmware file on the USB is newer than that on the TV Box and server).
5. Wait for the firmware file to unzip. Then click on UPGRADE.

A USB firmware upgrade will wipe out all settings, which means the TV Box will need reconfiguration afterwards.

Firmware Update – GENiO

GENiO provides the ability to push firmware updates to PDi TVs and TV Boxes remotely. See the GENiO manual PD196-466 for more information.

FACTORY RESET/ SYSTEM RECOVERY

1. Go to SETTINGS.
2. Scroll to the bottom of the SETTINGS page.
3. Click on SYSTEMS and go to RESET OPTIONS.
4. Click on ERASE ALL DATA (FACTORY RESET).
5. Confirm and click on “ERASE ALL DATA” once again.

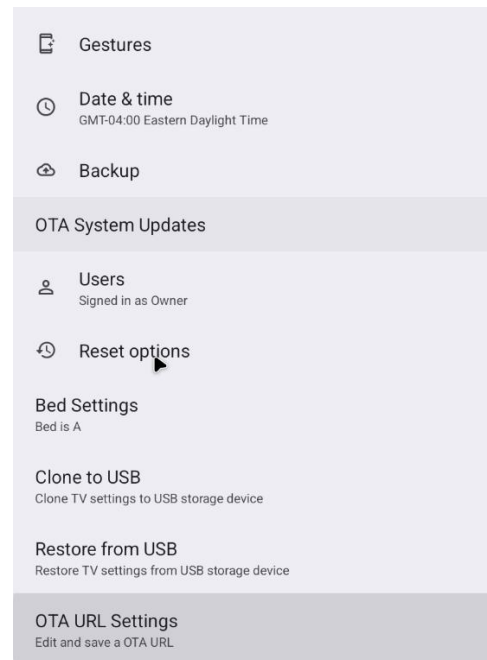

Bed Setting

This selects the bed location assigned to the TV Box. This setting is typically used in multi-bed environments to associate the TV with a specific patient bed.

1. Go to SETTINGS and then select SYSTEM.
2. Select BED SETTINGS.
3. Choose desired bed location.

USB CLONING

USB cloning lets you copy some configuration settings from one TV Box (the “master” to other TV Boxes (the “target” units)) using a USB drive. You can clone changes to your TV APP SETTINGS, such as Aspect Ratio and Sleep timer. To perform USB cloning:

1. On the Homepage, press 1 on the programming remote to go to Channel.
2. Select FEATURES.
3. From the three options that appear, select the bottom option "APP SETTINGS." Configure the TV Box as desired.
4. Click the back button to return to the homepage.
5. Press the TV SETUP button on the PDi programming remote to go into SETTINGS.
6. Scroll down to SYSTEM.
7. Scroll down to CLONE TO USB.
8. Insert a USB drive into one of the USB ports on the TV Box.
9. Click on CLONE. It should take a few seconds for cloning to finish.

Restore to TV

1. Go to SETTINGS and then to SYSTEM.
2. Scroll down to RESTORE FROM USB.
3. Insert the USB drive with the clone file into the USB-A port on the TV Box.
4. Click on RESTORE.
5. Your device will restart after cloning is completed.

Restoring from USB can also be achieved on the Setup wizard as discussed under “Set-Up Wizard” above.

672M0UE LG SERIES TV SETTINGS FOR HDMI CEC

Users of 672M0UE LG Series TVs can control the Power and Volume of their TV sets through the PDi TV Box using a PDi program/ patient remote control. To do this:

1. Get into the INSTALLER MENU on your LG TV.
2. Factory reset TV. Set 117 (FACTORY DEFAULT).
3. Enter 413, then 0413.
4. Set 042 (AUTO INPUTS) to 255.
5. Set 041 (SIMPLINK) to 001.

Configuration Section Complete

At this point:

- ✓ Optimal picture quality achieved
 - ✓ GENiO works correctly
- ✓ Channels configured correctly
 - ✓ Clean audio output

TROUBLESHOOTING TIPS

Analog pillow speaker problems	<ul style="list-style-type: none"> • Confirm pillow speaker is securely plugged in • Connect the pillow speaker directly to the TV box and verify that the across-room or bedside wiring is not faulted. • Check fluorescent lighting is not causing interference with the TV box's IR receiver
Pillow speaker not acting as expected (ie. press 2 but get a 5.)	<ul style="list-style-type: none"> • Verify that the nurse call system has the correct Personality Block enabled
Remote not working	<ul style="list-style-type: none"> • Check batteries in remote • Check Bed A, B, C, D setup is correct • Check fluorescent lighting is not causing interference with the TV box's IR receiver
No picture from external source	<ul style="list-style-type: none"> • Make sure external source is connected properly
Picture, but no sound	<ul style="list-style-type: none"> • Check HDMI is enabled • Confirm sound is not muted • Confirm no headphones are plugged in • If using an external source, confirm proper connection
Clone menu does not appear	<ul style="list-style-type: none"> • Verify "USB Media" source is disabled in Sources menu

LIMITED WARRANTY

PDi Communication Systems, Inc. ("PDi") standard warranty information is found at pdiam.com. For information regarding authorized servicing and all other information pertaining to this warranty, please contact PDi COMMUNICATION SYSTEMS, INC. at 40 Greenwood Ln, Springboro, Ohio 45066 or phone 800-628-9870 and ask for the PDi ProServices team.