



# K-Series LED HDTV

## **INSTALLATION & USER MANUAL**

Document Number: PD196-471R1

For model numbers  
PDI-K24A, PDI-K32A, PDI-K43A

This manual is intended for qualified installers and authorized hospital staff.  
Please read the safety and operating instructions and retain this document for future reference.

	<h1>K-Series TV</h1>	Document Number: PD196-471R1
	INSTALLATION & USER MANUAL	Page 2 of 27

## K-Series Documents

This TV comes with the following manuals. Please scan the QR code 1 below to access these resources. QR code 2 gives you access to the entire PDi document library.

- **User Manual (This document):** Safety information, TV installation, and setup guidelines
- **FAQs:** Answers to common K-Series questions

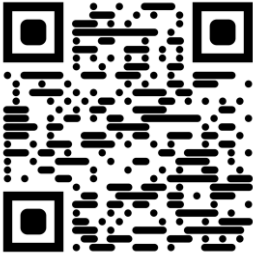

1. TV Manuals



2. PDi Document Library

### Pre-install checklist

Included in your package:

- PDi K-Series TV
- Power Cable

**The following important accessories are not included in your package and must be ordered separately:**

- PDi Master TV Programming Remote
- Approved Wall Mount Bracket
- Mounting Screws and Wall Anchors
- Coaxial RF Cable
- ¼" Pillow Speaker Jumper Cable

**Please have all necessary items on hand before beginning installation.**

### Copyright, Trademarks

© 2026 PDi Communication Systems, Inc. All rights reserved. PDi is a registered trademark of PDi Communication Systems, Inc. Manufactured under license from Dolby Laboratories. Dolby, Dolby Audio, and the double-D symbol are trademarks of Dolby Laboratories Licensing Corporation. The terms HDMI, HDMI High-Definition Multimedia Interface, and the HDMI Logo are trademarks or registered trademarks of HDMI Licensing Administrator, Inc. Product logos, brands and other trademarks displayed within PDi's products are the property of their respective trademark holders, who are not affiliated with, endorsing, or sponsoring PDi Communication Systems, Inc. or our product.

**Contents**

- Important Safety Instructions ..... 5
- Important Safety Instructions (French) ..... 7
- Installation ..... 8
  - Introduction to the PDi K-Series TV ..... 8
    - Ports ..... 8
    - Compatible Mount Bracket Information ..... 8
    - Preparing for Mount Installation ..... 8
    - Mounting ..... 8
    - Wall Mounting Options ..... 8
    - VESA Standard Mount Guidelines ..... 8
- Connections ..... 10
  - Wiring and Cabling ..... 10
    - Across-Room Wiring ..... 10
    - Coax Connection ..... 10
    - DVD Module ..... 10
  - Remote Controls & Keyboards ..... 12
    - Programming Remote Control ..... 12
    - Pillow Speakers ..... 12
  - Setup Configuration: Popular Settings ..... 13
  - Display Mode ..... 13
  - Closed Captions (CC) ..... 13
  - Channel Setup ..... 13
    - Service Level ..... 14
    - Configure Channels ..... 14
  - Channel Sources ..... 15
  - Parental Controls ..... 15
    - TV Rating ..... 15
    - TV Parental Guideline Rating System ..... 16
    - The Sub-rating of TV rating ..... 16
    - MPAA Rating ..... 16
    - Block Aux. Sources ..... 16
    - Parental Lock Duration ..... 17
    - Parental Lock ..... 17
  - Channel Sequence ..... 17
  - Power on Channel ..... 17
  - Channel Lock ..... 17
  - CH Mem Override/Auto Update ..... 17
  - Auto Channel Aliasing ..... 18
  - Clear Service Level ..... 18

Copy Service Level.....	19
TV Settings .....	19
Picture .....	19
Backlight.....	19
Advanced .....	20
Sound Settings .....	20
Sound mode .....	20
Internal Speaker .....	20
Min/ Max Volume.....	20
Power On Volume.....	20
Pillow Speaker Boost.....	21
Bass / Treble .....	21
Auto Volume.....	21
Advanced Sound effects.....	21
Language.....	21
Source Enable .....	22
HDMI ARC Audio Latency .....	22
Date & Time .....	22
Features.....	23
Auto Power On / Lock .....	23
Bed A/B/C/D.....	23
Pillow Speaker Type .....	23
Analog Pillow Speaker.....	23
System settings .....	23
Diagnostics.....	24
Standby Power .....	24
Reset All TV settings .....	24
Reset to Factory Default .....	25
USB Cloning.....	25
Restore Setting to TV.....	26
Security .....	26
Support.....	26
Firmware Upgrade .....	26
Troubleshooting Tips .....	27
Limited Warranty.....	27

## IMPORTANT SAFETY INSTRUCTIONS

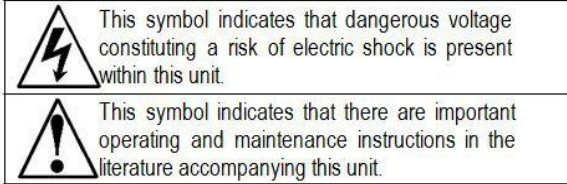

### Overhead Falling Hazard

TV can pose a striking hazard when mounted at an elevated position. Use only PDi mounting brackets, support arms, and appropriate hardware to assure TV will not fall from the mounted position. Failure to do so may cause injury or death.



### Rain and Moisture

WARNING: To avoid the hazards of fire or electrical shock, DO NOT expose this television to rain or moisture.



### Oxygen Environment

WARNING: Do not use in any oxygen tent or oxygen chamber. Such use may cause a fire hazard.



### Wet Locations

Do not use this television near water. Television shall not be exposed to dripping or splashing and no objects filled with liquids, such as vases, shall be placed on the television.

television reception, which can be determined by turning the equipment off and on, the user is encouraged to try to correct the interference by one or more of the following measures:

- Reorient or relocate the receiving antenna.
- Increase the separation between the equipment and receiver.
- Connect the equipment into an outlet on a circuit different from that to which the receiver is connected.
- Consult the dealer or an experienced radio/TV technician for help.

### Cleaning and Disinfection

Clean the exterior of this television by removing dust with a lint-free cloth. Spot test a new disinfectant by test cleaning a non-obvious small spot on the TV's back cabinet, keypad, and LCD panel. PDi recommends using a premoistened disinfectant cloth, like PD600-001 Super Sani-Cloth or similar, or spraying cleaner onto a dry cloth and then wiping the unit. Specific recommendations can be found at [www.pdiarm.com](http://www.pdiarm.com). CAUTION: To avoid damage to the surface of the television, do not use abrasive or chemical cleaning agents.

### Note to Cable TV Installer

Example of Antenna Grounding as per NEC - National Electrical Code

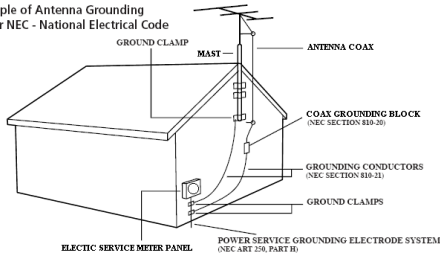

This reminder is provided to call the cable TV system installer's attention to Article 820-40 of the National Electrical Code.

The code provides guidelines for proper grounding and specifies that the cable ground shall be connected to the grounding system of the building, as close to the point of the cable entry as practical. Canadian installations shall be properly grounded in accordance with the Canadian Electrical Code, Part 1.

### FCC

This equipment has been tested and found to comply with the limits for a Class A digital device, pursuant to part 15 of the FCC Rules. These limits are designed to provide reasonable protection against harmful interference when the equipment is operated in residential or commercial installation. If this equipment does cause harmful interference to radio or

### Copyright, Trademarks

© 2026 PDi Communication Systems, Inc. All rights reserved. PDi is a registered trademark of PDi Communication Systems, Inc. Manufactured under license from Dolby Laboratories. Dolby, Dolby Audio, and the double-D symbol are trademarks of Dolby Laboratories Licensing Corporation. The terms HDMI, HDMI High-Definition Multimedia Interface, and the HDMI Logo are trademarks or registered trademarks of HDMI Licensing Administrator, Inc. Product logos, brands and other trademarks displayed within PDi's products are the property of their respective trademark holders, who are not affiliated with, endorsing, or sponsoring PDi Communication Systems, Inc. or our products.

### Underwriters Laboratories



This model Hospital Grade LED HDTV is a specialized TV and should be installed to National Electrical Code specifications. This device is safety tested and listed by the Underwriters Laboratories as a product suitable for use in healthcare facilities in both the United States and Canada.

**THIS INSTALLATION SHOULD BE DONE BY A QUALIFIED SERVICE PERSON AND SHOULD CONFORM TO ALL LOCAL CODES. READ AND FOLLOW THE SAFETY INSTRUCTIONS BEFORE ATTEMPTING THIS INSTALLATION.**

1. Read these Instructions – All the safety and operating instructions should be read before the product is operated.
2. Keep these Instructions – The safety and operating instructions should be retained for future reference.
3. Heed all warnings – All warnings on the product and in the operating instructions should be adhered to.
4. Follow all instructions – All warnings on the product and in the operating instructions should be followed.
5. Do not use this apparatus near water – for example, near a bathtub, wash bowl, in a wet basement; or near a swimming pool; and the like.
6. Cleaning – Please see specific recommendations under “Cleaning and Disinfection” on previous page.
7. Do not block any ventilation openings. Install in accordance with the manufacturer’s instructions. The openings should never be blocked by placing the product on a bed, sofa, rug, or other similar surface.
8. Do not install near any heat sources such as radiators, heat registers, stoves, or other apparatus (including amplifiers) that produce heat.
9. DO NOT defeat the safety purpose of the polarized or grounding-type plug. This product is equipped with a three-wire grounding-type plug, a plug having a third (grounding) pin. This plug will only fit into a grounding-type power outlet. This is a safety feature. If you are unable to insert the plug into the outlet, contact your electrician to replace your obsolete outlet.
10. Protect the power cord from being walked on or pinched particularly at plugs, convenience receptacles, and the point where they exit from the product.
11. Attachments only use attachments/accessories specified by the manufacturer.
12. Use only with the cart, stand, tripod, bracket, or table specified by the manufacturer, or sold with the apparatus. When a cart is used, use caution when moving the cart/apparatus combination to avoid injury from tip-over.



13. Refer all servicing to qualified service personnel. Servicing is required when the apparatus has been damaged in any way, such as power-supply cord or plug is damaged, liquid has been spilled or objects have fallen into the apparatus, the apparatus has been exposed to rain or moisture, does not operate normally, or has been dropped.
14. Power Sources – This product should be operated only from the type of power source indicated on the marking label. If you are not sure of the type of power supply to your facility, consult your product dealer or local power company. For products intended to operate from battery power, or other sources, refer to the operating instructions.
15. Oxygen Environment – Do not use in an oxygen tent or oxygen chamber. Such use may cause a fire hazard.
16. Lightning – For added protection for this product during a lightning storm, or when it is left unattended and unused for extended periods of time, unplug it from the wall outlet and disconnect the antenna or cable system. This will prevent damage to the product due to lightning and power-line surges.
17. Servicing – Do not attempt to service this product yourself as opening or removing covers may expose you to dangerous voltage or other hazards. Refer all servicing to qualified service personnel.

## IMPORTANT SAFETY INSTRUCTIONS (FRENCH)

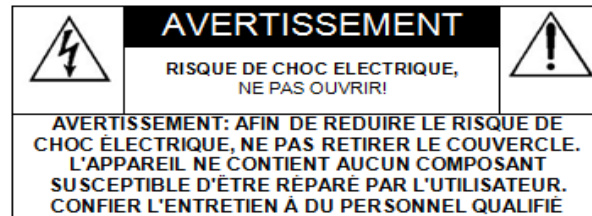
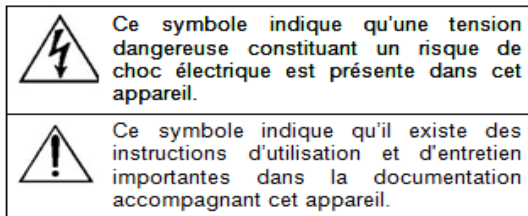

### Danger chute d'objets



AVERTISSEMENT: Afin d'éviter toute blessure, cet appareil doit être solidement fixé au sol/mur conformément aux instructions d'installation. Les télévisions peuvent présenter un risque de heurt

lorsqu'elles sont montées en position élevée. Utiliser uniquement des supports de montage, des bras de support et le matériel approprié de PDi afin d'assurer que la télévision ne tombe pas de sa position de montage. Le non-respect de ces instructions peut causer des blessures ou la mort.

### Pluie et humidité



AVERTISSEMENT: Afin d'éviter les risques d'incendie ou de choc électrique, NE PAS exposer cette télévision à la pluie ou à l'humidité ou l'utiliser dans un endroit humide.

### Environnement d'oxygène



AVERTISSEMENT: Ne pas utiliser dans une tente à oxygène ou chambre à oxygène. Une telle utilisation peut causer un risque d'incendie.

**CONSIGNES DE SÉCURITÉ IMPORTANTES**  
**CETTE INSTALLATION DOIT ÊTRE EFFECTUÉE PAR UN TECHNICIEN QUALIFIÉ ET DOIT ÊTRE CONFORME À TOUS LES**  
**CODES LOCAUX. LIRE ET SUIVRE LES CONSIGNES DE SÉCURITÉ AVANT DE PROCÉDER À L'INSTALLATION.**

1. Lire ces instructions. Toutes les consignes de sécurité et d'utilisation doivent être lues avant d'utiliser le produit.
2. Conserver ces instructions. Les consignes de sécurité et d'utilisation doivent être conservées pour référence future.
3. Respecter tous les avertissements. Tous les avertissements sur le produit et dans les consignes d'utilisation doivent être respectés.
4. Suivre toutes les instructions. Tous les avertissements sur le produit et dans les consignes d'utilisation doivent être suivis.
5. Ne pas utiliser cet appareil près de l'eau - par exemple près d'une baignoire, d'un lavabo, dans un sous-sol humide, ou près d'une piscine ou similaire.
6. Veuillez voir les recommandations sous "Nettoyage et Désinfection" à la Page précédente.
7. Ne pas obstruer les ouvertures de ventilation. Installer conformément aux instructions du fabricant. Les ouvertures ne doivent jamais être obstruées en plaçant le produit sur un lit, un canapé, un tapis ou toute autre surface similaire.
8. NE PAS installer près de sources de chaleur telles que radiateurs, registres de chaleur, poêles ou tout autre appareil (y compris les amplificateurs) qui produit de la chaleur.
9. NE PAS neutraliser le dispositif de sécurité de la fiche polarisée ou de terre. Ce produit est équipé d'une prise de terre à trois fils, une fiche ayant une troisième broche (mise à la terre). Cette fiche ne peut s'insérer que dans une prise de courant avec mise à la terre. Il s'agit d'une caractéristique de sécurité. Si vous êtes incapable d'insérer la fiche dans la prise, contacter votre électricien pour remplacer votre prise obsolète.
10. Protéger le cordon d'alimentation pour qu'il ne soit pas piétiné ni pincé, en particulier au niveau des fiches, des prises de courant et au point de sortie de l'appareil.
11. Accessoires - Utiliser uniquement les attaches/accessoires recommandés par le fabricant.
12. Utiliser uniquement avec un chariot, stand, trépied, support ou table recommandé par le fabricant ou vendu avec l'appareil.
13. Confier toute réparation à un personnel de service qualifié. Des réparations sont nécessaires si l'appareil est endommagé d'une façon quelconque, par exemple : cordon ou prise d'alimentation endommagé, liquide renversé ou des objets sont tombés dans l'appareil, l'appareil a été exposé à la pluie ou à l'humidité, ne fonctionne pas normalement ou s'il est tombé.
14. Sources d'alimentation - Ce produit doit être utilisé uniquement à partir du type de source d'alimentation indiqué sur l'étiquette. Si vous n'êtes pas sûr sur le type d'alimentation de votre domicile, consultez le détaillant de votre produit ou la compagnie d'électricité locale. Pour les produits proposés de fonctionner par piles, ou autres sources d'alimentation, reportez-vous aux consignes d'utilisation.
15. Environnement d'oxygène - Ne pas utiliser sous une tente à oxygène ou chambre à oxygène. Une telle utilisation peut causer un risque d'incendie.
16. Foudre - Pour une protection supplémentaire pour ce produit lors d'un orage, ou lorsqu'il est laissé sans surveillance et inutilisé pendant de longues périodes de temps, le débrancher de la prise murale et déconnecter l'antenne ou le système de câble. Cela permettra d'éviter tout dommage à l'appareil causé par la foudre et par les surtensions des lignes électriques.
17. Entretien - N'essayez pas de réparer ce produit vous-même car l'ouverture ou le retrait des couvercles peut vous exposer à une tension dangereuse ou à d'autres dangers. Confiez toutes les réparations à un technicien qualifié.

# INSTALLATION

This section is for installers

## INTRODUCTION TO THE PDI K-SERIES TV Ports

### A) Side Ports

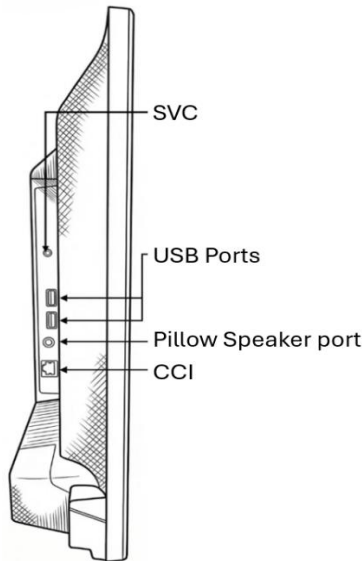

### B) Rear Ports

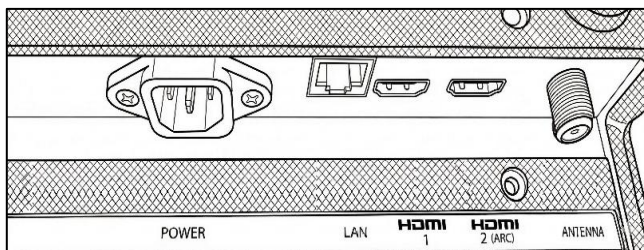

### Compatible Mount Bracket Information

This TV's User manual only provides the first steps to prepare the TV for mount installation. Please see your mount's installation guide for detailed instructions.

### Preparing for Mount Installation

- Prepare the TV for the Mount Bracket before making cable connections.
- It's safest to keep the TV in an upright, vertical position to prevent the screen from cracking.
- When carrying the TV, always hold it firmly by its outer frame and position one hand on the top frame and one on the bottom frame.  
For any large TV, always use two or more people to share the weight.
- Follow all the instructions provided in the Mount Bracket installation guide.

### Mounting

The K-Series family of televisions can be mounted with table stands and set on a horizontal surface or be mounted on a wall. PDi offers a range of options for mounting. Contact PDi for more information.

### Wall Mounting Options

When mounting the K-Series on a wall, it is recommended to maintain **at least 4 inches** of clearance on all four sides to permit proper ventilation as depicted in the diagram below.

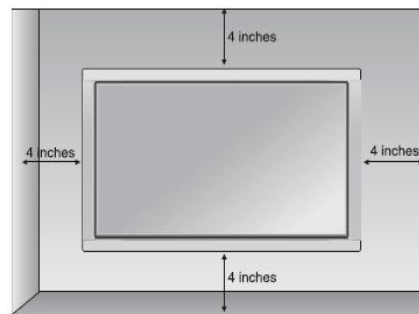

### VESA Standard Mount Guidelines

When mounting on a wall, the following considerations should be kept in mind:

- Each size of TV has a VESA pattern to enable mounting. See the table below for more details.
- Follow all instructions for the wall mounting assembly per the manufacturer's recommendations. NOTE: Screw length depends on the wall mount and configuration. See K-Series VESA dimensions below. A and B below are VESA hole patterns.

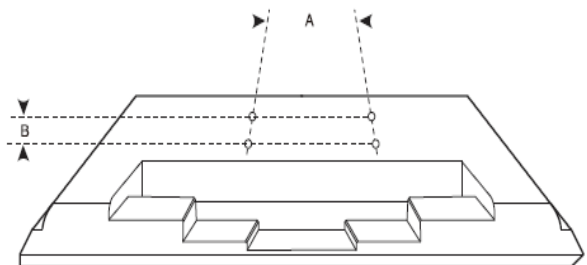

Model	VESA (AXB)	Screw
PDI-K24A	100 X 100	4mm threads
PDI-K32A	100 X 100	6mm threads
PDI-K43A	200 X 200	6mm threads

**PDI-K24A**

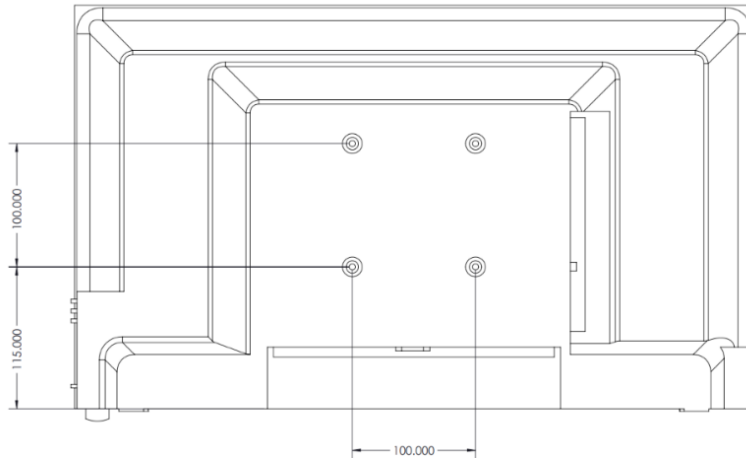

**PDI-K32A**

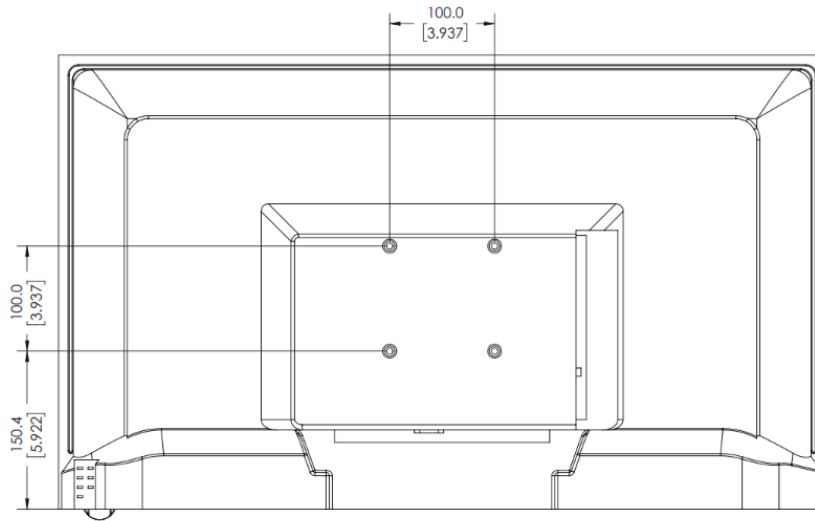

**PDI-K43A**

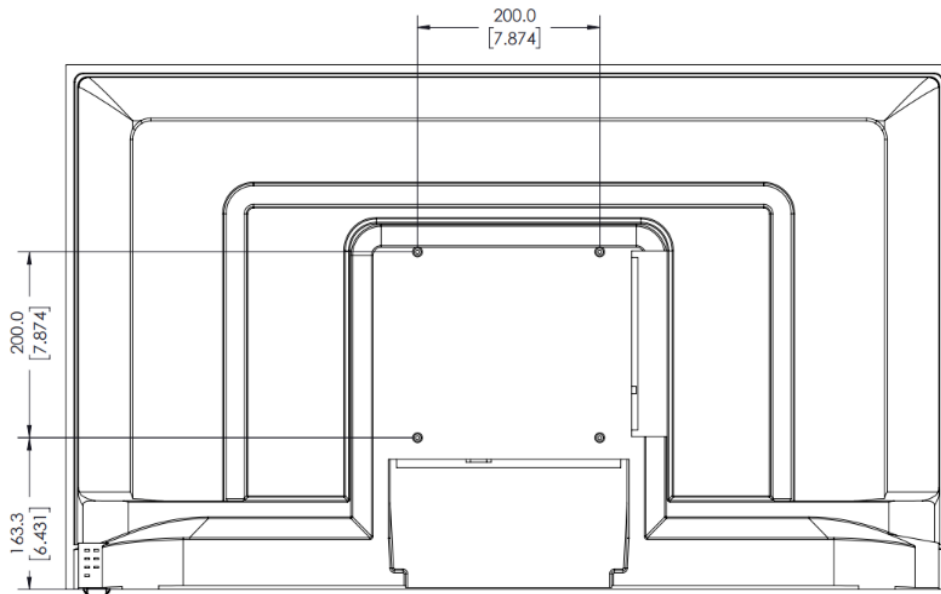

**CONNECTIONS**  
Installation section cont'd

**WIRING AND CABLING**

**Across-Room Wiring**

**NOTE:** For pillow speaker remote control via cross room wiring, a jumper cable is typically required to make a connection across the room to the TV. See diagram below. The jumper cable is not included with the TV and may be ordered separately. A few different types of jumper cables that can be purchased from PDi are illustrated below.

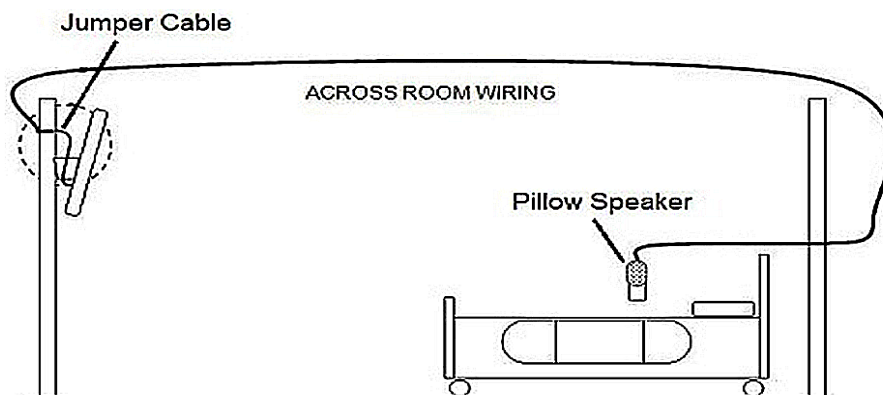
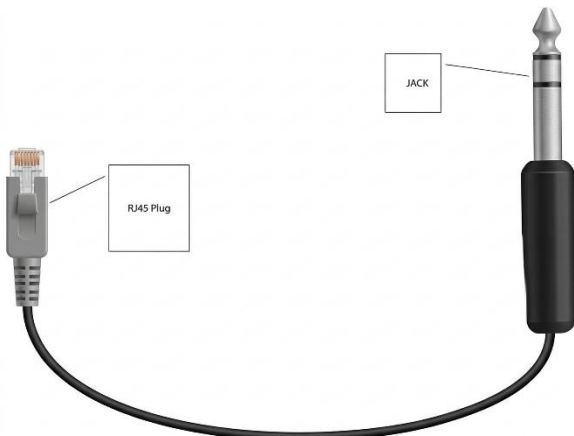
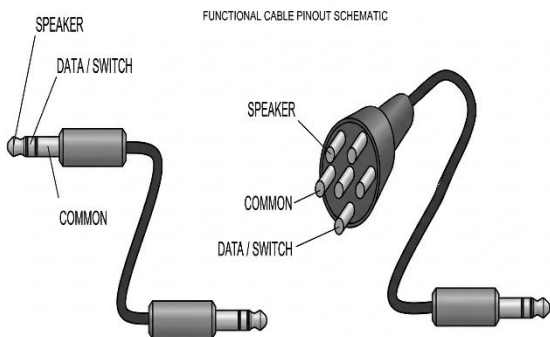

**CAUTION:** Some hospital cable systems provide power voltage on the coaxial cable. This TV is NOT designed to be powered via a coaxial cable. **DO NOT** connect to a powered coaxial cable. This will damage the TV.

This TV is **NOT** designed to be powered via coax cable.

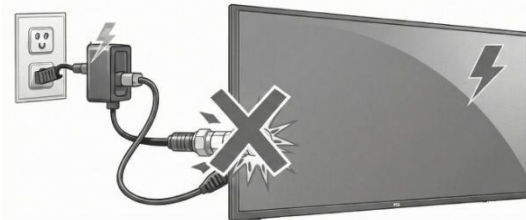

**Coax Connection**

Do not overtighten coax cable when connecting it to the RF connector. Tighten to no more than 18-20 in-lbs. of torque. If a proper torque wrench is unavailable, finger tighten until the nut on the cable does not move easily, then tighten no more than an additional 1/8 turn.

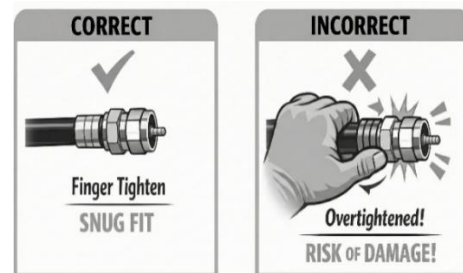

**DVD Module**

This model K-Series television is NOT compatible with the PDi DVD module, PD251-043-1.

**Hardware Installation Complete.**

At this point:

- ✓ TV is safely mounted
- ✓ Cables are connected
- ✓ Power verified
- ✓ Boot screen confirmed

**Further configuration should be performed by qualified and authorized installers or facility personnel only.**

**Please refer qualified Facility Staff to Part II of this document.**



## Part II: Setting up the TV

This section is for hospital IT staff

### REMOTE CONTROLS & KEYBOARDS

A programming remote control, PD108-520, is required to perform all setup operations for the television. These remotes will operate any PDi TV regardless of the TV's Bed A/B/C/D setting. Because these remotes have the TV SETUP button to gain full access to the TV's menus, patients should not have access to them. PDi offers other remotes designed for patient use (PD108-527).

#### Programming Remote Control

**Power, setup, and the directional buttons will be the main buttons used on the programming remote.** See PDi document PD196-446 for additional information on the PD108-520 remote. **If prompted to provide it, the admin code for configurations is 45066.**

Alternative ways to configure your TV include using a keyboard and mouse (PD161-004) or a pillow speaker. However, configuring with a pillow speaker is not ideal.

#### Pillow Speakers

A ¼" stereo-style pillow speaker (pendant control) jack is located on the TV's connector panel on the side of the TV. This TV is designed for 5V pillow speaker voltage and works with a digital pillow speaker that generates digital-style control codes. The TV is compatible with universal pillow speaker recognition code set.

To make full use of the features available to patients on PDi K-Series TVs, PDi recommends selecting a pillow speaker with the following buttons: **HOME, BACK, NAVIGATION ARROWS, and OK/SELECT.**

The table below details the function of the main buttons on the programming remote.

Label	Function
1	Turn selected device on and off
2	Access remote control setup
3	Navigate on-screen menus and adjust settings

#### Main buttons on pillow speakers

Label	Function
4	Exit to main system dashboard
5	Return to the previous screen or menu level

### A. Programming Remote Control

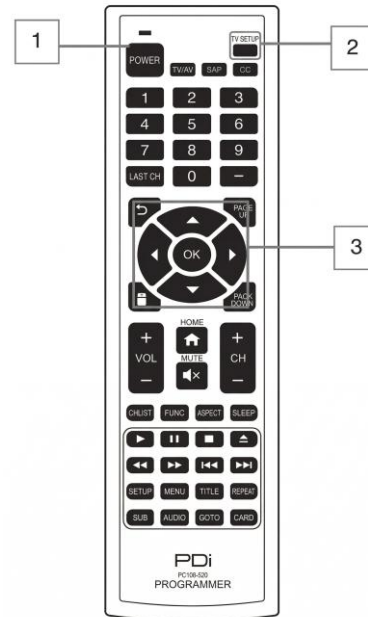

### B. Keyboard and Mouse

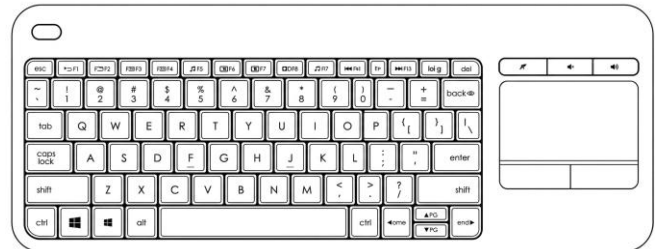

### C. Pillow Speakers

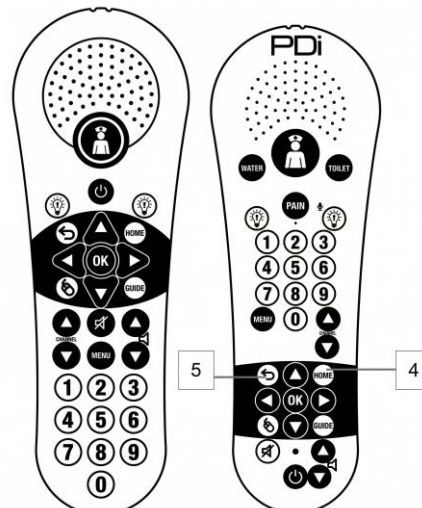

### SETUP CONFIGURATION: POPULAR SETTINGS

The following instructions assume you have a programming remote, have correctly mounted the TV, and connected power and RF signal. Access the menus by pressing TV SETUP on the remote. These menus allow you to add TV channels, adjust the picture and sound, setup external components, and control settings.

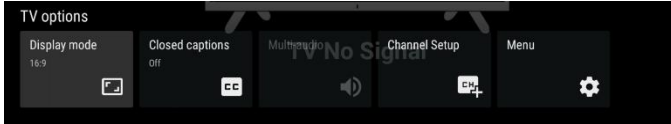

### DISPLAY MODE

This menu allows you to change your aspect ratio. To make changes to your Display settings:

1. Press the TV SETUP button to bring up TV Options.
2. Select DISPLAY mode.
3. Press ▲ or ▼ to highlight your desired aspect ratio/ scaling mode and OK to choose it.

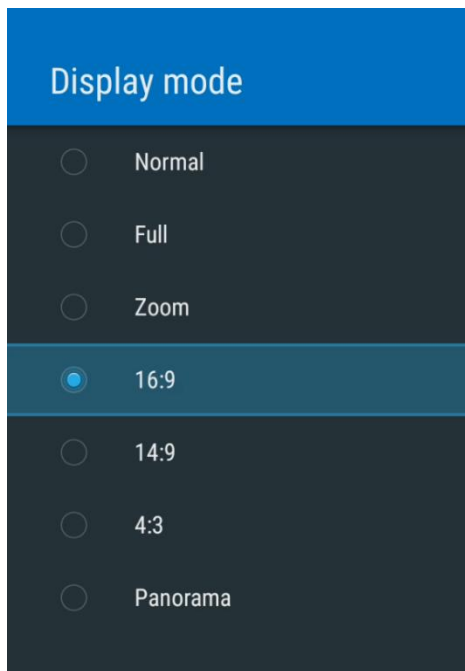

### CLOSED CAPTIONS (CC)

This menu provide a text-based, accessible version of all audio, including dialogue, music, and sound effects.

1. Press the TV SETUP button to bring up TV Options.
2. Press ► to highlight CLOSED CAPTIONS and OK to select it.
3. Press ▲ or ▼ to highlight your desired CC and OK to choose it.

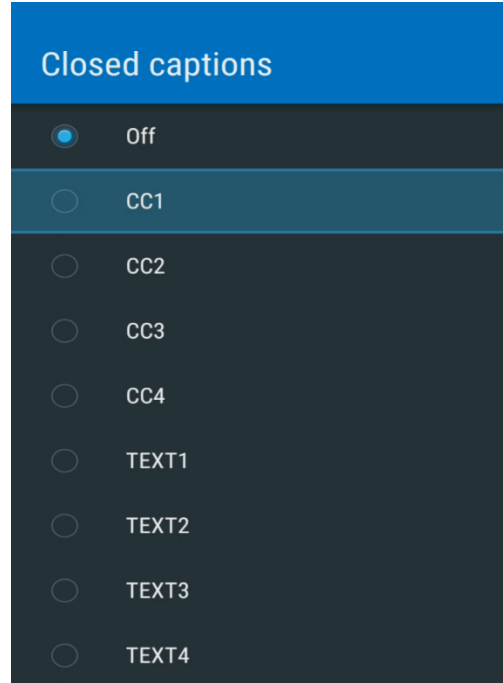

### CHANNEL SETUP

The Channel Setup menu allows you to program different signal sources into three Service Levels (Free, Basic, and Premium) and to add or delete individual channels. It also allows you to block channels, TV programs, movies, and auxiliary sources. Each Service Level contains a different channel map.

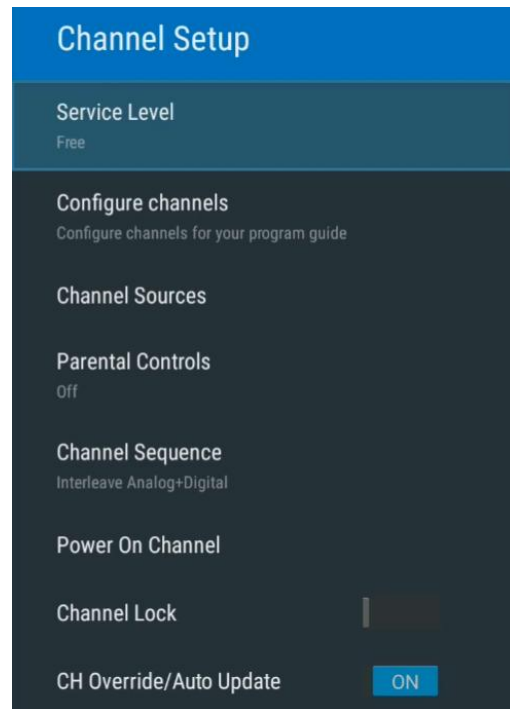

### Service Level

This TV contains three separate Service Levels, allowing the hospital to offer either basic or enhanced viewing.

- **FREE:** This lets patients watch hospital education and information channels without renting the TV. The channels containing programming for no charge are typically programmed into this level of service. This is the factory default setting for Service Level.
- **BASIC:** This service level typically allows additional channels beyond those offered in the FREE level.
- **PREMIUM:** This is the highest service level with typically the most channels available for viewing.

To change your Service level:

1. Press the TV SETUP button to bring up TV Options.
2. Press ► to highlight CHANNEL SETUP and OK to select it.
3. Select SERVICE LEVEL and use ▲ or ▼ to choose your desired option.

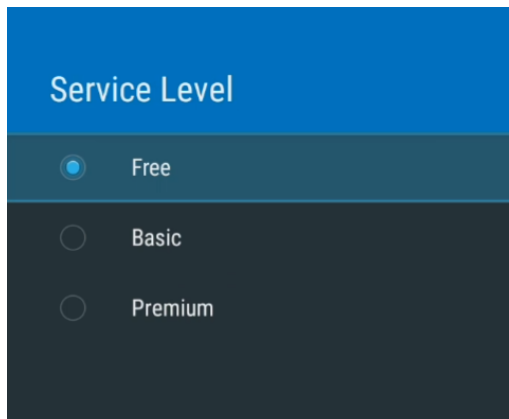

### Configure Channels

The Configure Channels page lets you organize your channels.

1. Press the TV SETUP button to bring up TV Options.
2. Press ► to highlight CHANNEL SETUP and OK to select it.
3. Press ▼ to choose CONFIGURE CHANNELS.
4. The Configure Channels menu display provides a list of active channels found after an **auto channel search**. The Configure Channels process becomes much easier when you scan your channels before moving on to this step.

**NOTE:** Your display will appear different, since your channel lineup is likely different.

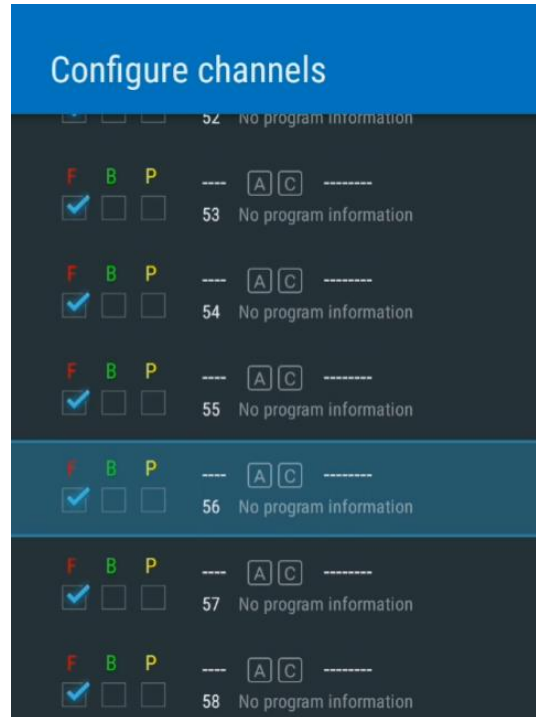

### TYPE

The type of channel is listed in the middle of the page with the following abbreviations.

- AC Analog Cable
- DC Digital Cable
- AA Analog Air
- DA Digital Air

On this page, you can also manually change the Service level for individual channels. F stands for Free, B for Basic and P for Premium.

1. Press ▲ or ▼ to highlight a channel and press 1 on the Programming remote to select or deselect F.
2. Press 2 on the Programming remote to select or deselect B.
3. Press 3 on the Programming remote to select or deselect P.

If you're not looking to restrict access to any channel, it is advisable to set all channels to all three Service levels.

## CHANNEL SOURCES

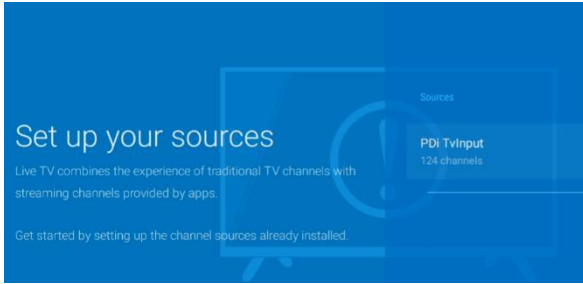

Channel Sources lets the TV scan each available channel for activity. Channels that display activity are memorized into the chosen Service Level.



**NOTE:** A programmed service level can also be reprogrammed if desired. Digital channel auto programming may take longer than 10 minutes to complete.

1. In Channel Setup menu, press ▲ or ▼ to highlight CHANNEL SOURCES.
2. Press OK to select it. Press ► to highlight the PDI TVINPUT and press OK. This takes you to the “TV Channel Tuner Setup,” where you can configure the TV scan. Use the arrow keys on the program remote to perform these configurations.

**Antenna Type:** Choose an option based on what antenna type/ cable is supplied to your facility.

**V-Loc Timeout:** Choose the amount of time the TV searches for a channel band.

**Search Level:** Choose between FREE, BASIC, OR PREMIUM Service Levels.

**Channel Mode:** Choose scope of channel scanning. **Analog Only** searches for analog TV channels only.

**Digital Only** searches for digital TV channels only. **Analog and Digital** searches for both analog and digital channels.

**Additional Digital:** This gives you the option to search for additional channels **over the air**.

**NOTE:** Only the primary signal type will be scanned for digital channels

3. After configuring the TV Channel Tuner Setup as desired, press the AUTO SCAN button to start scanning. Auto scanning may take several minutes to complete.

## PARENTAL CONTROLS

Parental Control allows you to block channels, TV shows, movies, and devices that are connected to the TV.

1. Press the TV SETUP button to bring up TV Options.
2. Press ► to highlight CHANNEL SETUP and OK to select it.
3. Press ▼ to choose PARENTAL CONTROLS.
4. Press OK to select it and create a PIN.

## TV Rating

Most TV programs are now rated. TV Rating allows the TV to selectively present only programming content that is unblocked per its preset level. A program that is blocked displays a black screen only. **NOTE:** The U or B (unblocked or blocked) will turn red when it is highlighted. Categories that are rated for older audiences will be automatically blocked. If you block TV-Y category, then TV-Y7 will be blocked automatically. Similarly, if you block TV-G category, then TV- PG, TV-14 and TV-MA will also be blocked.

1. From the Parental Control menu, enter the TV RATING menu.
2. Press ▲ or ▼ to move to one of the six age-based categories.
3. Press ◀ or ▶ to cycle through the sub-ratings (ALL, FV, V, S, L or D) or exit out of the sub-categories in that category.
4. Press ▲ or ▼ to change the sub-rating.
5. Press the SETUP button to return to the previous menu. Or press ◀ to get out of the sub-category.

## TV Parental Guideline Rating System

	Guide	Meaning
TV-Y	Young Children	Content not offensive to most viewers.
TV-Y7	Children 7 and over	Considered suitable for children over 7, may contain Fantasy Violence Scenes.
TV-G	General Audience	Considered suitable for all audiences; children may watch unattended.
TV-PG	Parental Guidance	Suggested Unsuitable for younger children, may contain: Suggestive Dialog, Bad Language, Sex, and Violence Scenes
TV-14	Parents Strongly Cautioned	Unsuitable for children under 14, may contain: Strong Dialog, Bad Language, Sex, and Violence Scenes.
TV-MA	Mature Audience Only	Adults only, may contain: Strong Dialog, Bad Language, Sex, and Violence Scenes.

## The Sub-rating of TV rating

Grade	Meaning
FV	Fantasy Violence
V	Violence
S	Sexual Situation
L	Adult Language
D	Sexual Suggestive Dialog

## MPAA Rating

Most televised movies are now rated. MPAA Rating selectively allows the TV to only present movie content that is unblocked per its preset level.

1. From the Parental Control menu, enter the MPAA Rating menu.
2. Press ▲ or ▼ to highlight a particular MPAA Rating.
3. Press ◀ or ▶ to select Blocked or Unblocked.
4. Press SETUP to return to the previous menu. To exit, press SETUP until the programming menus disappear.

**NOTE:** Parental Control will automatically block any category that is rated for older audiences. For example, if you block the PG-13 category, then R, NC-17 and X will be automatically blocked also.

## Motion Picture Association of USA (MPAA) Rating System

	Guide	Meaning
G	General Audiences	Content not offensive to most viewers.
PG	Parental Guidance Suggested	Content is such that parents may not want their children to view the program.
PG-13	Parents Strongly Cautioned	Program is inappropriate for preteens, with a greater degree of offensive material Suggested than a PG rated program.
R	Restricted Viewing	Not for children under age 17. Strong elements of sex and/or violence.
NC-17	No Children under age 17	Not for children under age 17 under any circumstances. Strong sexual content.
X	Hard Core Films	Same as NC-17 rating.
No Rating	No Rating	MPAA Not Rated

**NOTE:** Digital Rating and Clear Digital/Download New are available when the current TV channel contains new parental control (Open V-Chip) rating information.

The Parental Control access password can be changed using this menu.

**NOTE:** The factory default password that is programmed into the TV is 0000.

1. From the Parental Control menu, enter the Change Password menu.
2. Enter a new password by using the number buttons on the remote.
3. Confirm the password by entering the same digits. After confirming the password, the TV will return to the Parental Control menu.

## Block Aux. Sources

Like TV programs and channels, the auxiliary sources can be blocked too. When the TV encounters an external signal source that is not appropriate per its settings, a black screen appears with muted sound.

**NOTE:** Parental Lock must be enabled for the sources to be blocked.

1. In the Parental Control menu, press ▲ or ▼ to highlight AUX. BLOCK SOURCE.
2. Press ◀ or ▶ to select UNBLOCKED or BLOCKED.
3. Press TV SETUP to return to the previous menu. To exit, press TV SETUP until the programming menus disappear.

### Parental Lock Duration

This sets how long an enabled Parental Lock will be active.

1. In the Parental Control menu, press ▲ or ▼ to highlight PARENTAL LOCK DURATION.
2. Press ◀ or ▶ to select the desired number of hours (1-99) or ALWAYS.
3. Press the TV SETUP button to return to the previous menu. To exit, press TV SETUP until the programming menus disappear.

### Parental Lock

This enables or disables the settings in the Parental Control menu. Enabling it will require the password to be entered to access the Parental Control menu in the future.

1. In the Parental Control menu, press ▲ or ▼ to highlight PARENTAL LOCK.
2. Press ◀ or ▶ to select ENABLE or DISABLE.
3. Press the TV SETUP button to return to the previous menu. To exit, press TV SETUP until the programming menus disappear.

### CHANNEL SEQUENCE

From here, you choose to:

- **Interleave Analog + Digital:** Channels are displayed in the order of channel number.
- **Display All Analog then Digital:** All digital channels are displayed after all analog channels.

To change your Channel sequence:

1. Press ▲ or ▼ to highlight CHANNEL SEQUENCE.
2. Press ◀ or ▶ to select the CHANNEL SEQUENCE in which the channels are displayed.

### POWER ON CHANNEL

This displays a certain channel each time the TV is turned on. This feature is useful for hospitals that have a Welcome Channel and wish to have it displayed upon initial use of the TV. The patient can then tune to any other available channel. Each service level is programmed separately. "LAST" will cause the TV to turn on to the last channel before it was turned off.

**NOTE:** If Power on Channel is set to "LAST" and the physical power is removed, the TV will power on with the lowest programmed channel.

1. Enter the Channels menu.
2. Press ▲ or ▼ to highlight POWER ON CHANNEL.
3. Press OK to select it.
4. Press ▲ or ▼ to highlight the desired Service Level (FREE, BASIC, OR PREMIUM).
5. Press ▲ or ▼ to scroll through the channels currently available in the Service Level or LAST.
6. Press the SETUP button to return to the previous menu. To exit, press SETUP until the programming menus disappear.

### CHANNEL LOCK

This locks the currently viewed channel and prevents patients from tuning to any other channel. This feature is useful when the TV is used for information display purposes.

1. Enter the Channels menu.
2. Press ▲ or ▼ to highlight CHANNEL LOCK.
3. Press OK to toggle ON/ OFF.

### CH MEM OVERRIDE/AUTO UPDATE

This allows a channel to be entered with the remote's number buttons that is not memorized in the current Service level.

1. Enter the Channels menu.
2. Press ▲ or ▼ to highlight CHANNEL MEMORY OVERRIDE.
3. Press OK to select Enabled or Disabled.  
**DISABLED:** Service Level Channels only.  
**ENABLED:** All possible channels.
4. Press the SETUP button to return to the previous menu. To exit, press SETUP until the programming menus disappear.

## AUTO CHANNEL ALIASING

This feature provides a means to alias channels automatically with less manual intervention.

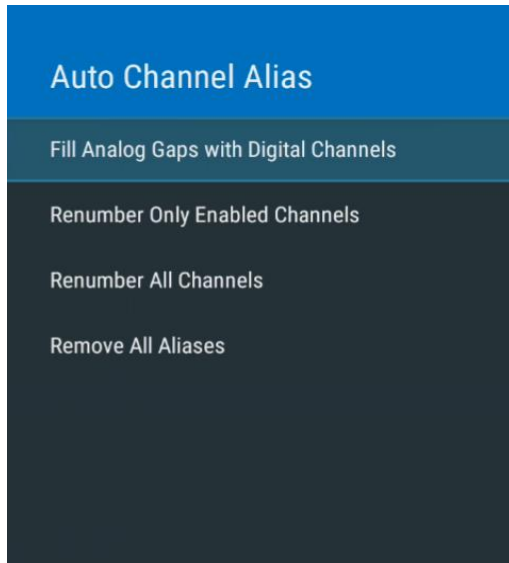

1. Enter the Channels menu.
2. Press ▲ or ▼ to highlight AUTO CHANNEL ALIAS. If the TV's Channels menu lacks this item, the TV does not support Channel Aliasing.
3. Press ► to select it.
4. In the Auto Channel Alias menu, three different methods are available to Alias channels. Each method is explained below. Select the first menu item: "Fill Analog Gaps with Digital Channels."

If a previous channel alias exists, a confirmation window appears "Remove existing aliases and renumber channels". Select YES to continue.

**Fill Analog Gaps with Digital Channels:** As the menu title states, gaps between Analog Channels are populated with Digital Channels.

**Renumber only Enabled Channels:** Active channels are renumbered. This Aliasing scheme usually results in each original channel number changed to a different number.

**Renumber all Channels:** All active Analog channels and all Digital Channels (both Active and Disabled) are renumbered.

**Remove All Aliases:** Removes all present aliases and restores the channels to their original numbers.

## CLEAR SERVICE LEVEL

This empties a service level of all its programmed channels, leaving it blank. NOTE: After a Service Level is cleared, the TV returns to the Clear Service Level menu. "Blank" will appear to the right of the Service Level.

1. Enter the Channels menu
2. Press ▼ to highlight CLEAR SERVICE LEVEL.
3. Press OK to select it.
4. Press ▲ or ▼ to highlight the Service Level (FREE, BASIC, OR PREMIUM).
5. Press ► to select the highlighted Service Level.
6. A confirmation page will appear. Press ▲ to proceed. Press ▼ or SETUP to return to the previous menu.
7. Press SETUP to return to the previous menu. To exit, press SETUP until the programming menus disappear.

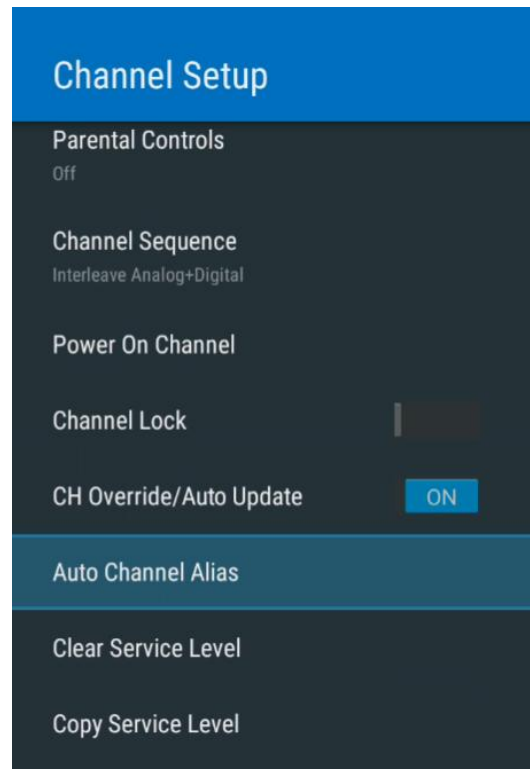

### COPY SERVICE LEVEL

This copies one Service Level's channels to another.

**NOTE:** After a Service Level is copied, the TV returns to the Copy Service Level menu. If the "TO SERVICE LEVEL" has been set to active in the Service Level setting (see Service Levels on page 16), TV programming will appear.

1. Enter the Channels menu.
2. Press ▼ to highlight COPY SERVICE LEVEL.
3. Press OK to select it.
4. Press ▲ to set the "FROM SERVICE LEVEL." Press ▼ to set the TO SERVICE LEVEL.
5. Press ► to copy the Service Level.
6. A confirmation page will appear. Press ▲ to proceed. Press ▼ or SETUP to return to the previous menu.
7. Press SETUP to return to the previous menu. To exit, press SETUP until the programming menus disappear.

To change your Picture settings:

1. Press the TV SETUP button to bring up TV Options.
5. Press ► to highlight MENU and OK to select it.
6. Select PICTURE to open the picture menu and choose PICTURE.
7. Use ▲ or ▼ to choose your preferred picture mode from the available options.
8. Press OK to confirm your selection.

### TV SETTINGS

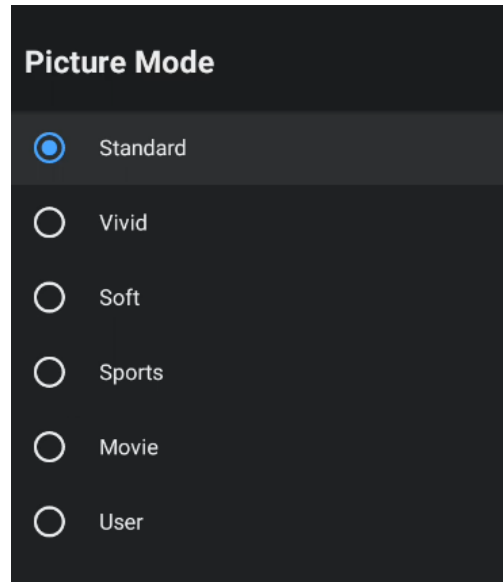
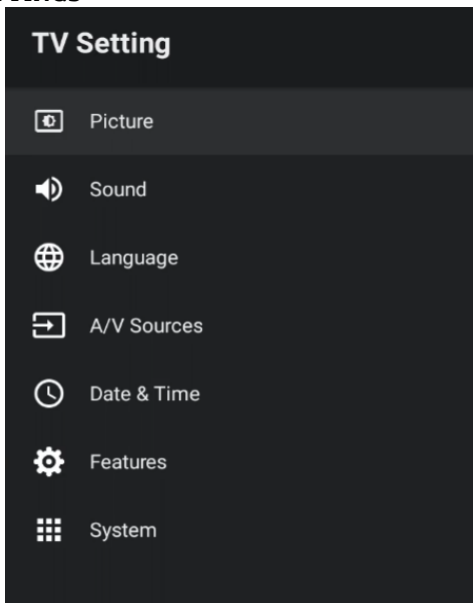

### Backlight

Backlight controls the brightness of the light behind the TV screen.

1. Press the TV SETUP button to bring up TV Options.
2. Press ► to highlight MENU and OK to select it.
3. Select PICTURE to open the picture menu and choose PICTURE.
4. Choose BACKLIGHT and adjust as needed.

### Picture

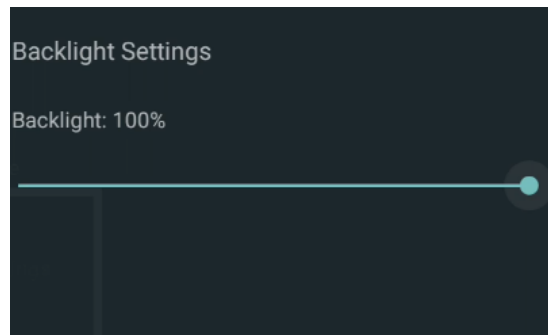
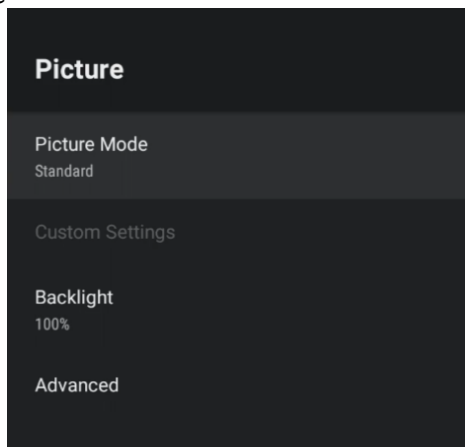

## Advanced

Advanced picture setting allows you to tweak color temperature, HDMI color range mode, local dimming, etc. To access Advanced picture settings, enter the picture menu, choose picture, and select **ADVANCED**.

## SOUND SETTINGS

This menu allows you to select a preset sound profile to optimize audio for different types of content.

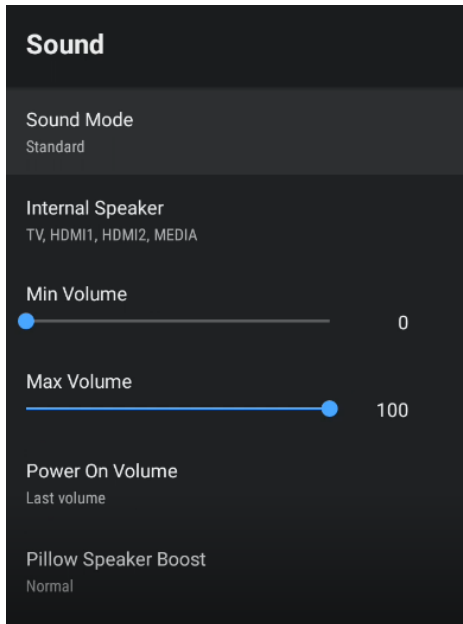

## Sound mode

Sound mode lets you choose a preset audio profile for the TV speakers. Each mode adjusts things like bass, treble, and clarity to match different types of content.

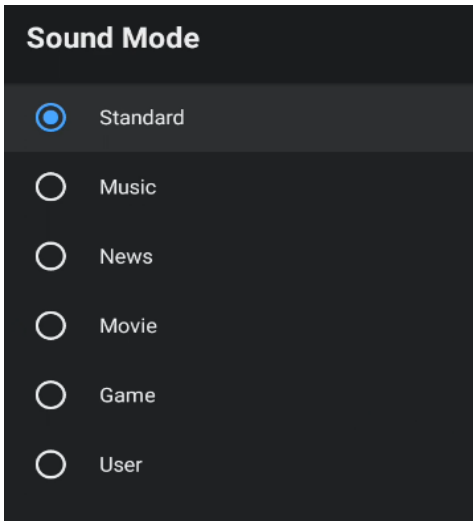

To change Sound Mode:

1. Press the TV **SETUP** button to bring up TV Options.
2. Press **▶** to highlight **MENU** and **OK** to select it.
3. Select **SOUND** to open the sound menu and choose **SOUND MODE**.
4. Choose your desired option and press **OK**.

## Internal Speaker

The Internal Speaker setting indicates that audio from the selected input sources is played through the TV's built-in speakers. These sources include TV broadcasts, HDMI devices, and media playback by default.

To change internal speaker settings, **enter SOUND MENU, select INTERNAL SPEAKER**, and select/deselect options as desired. Other **SOUND** settings you can configure are explained below. Configure them by entering **MENU** and choosing **SOUND**.

## Min/ Max Volume

Minimum volume sets the lowest volume level the TV can be adjusted to. This prevents the volume from being reduced below the selected level. Maximum volume sets the highest volume level allowed on the TV. This prevents the volume from being increased beyond the selected limit.

1. Enter the Sound menu.
2. Press **▲** or **▼** to highlight **MIN VOLUME OR MAX VOLUME**.
3. Press **◀** or **▶** to select the desired number (0-100).
4. Press **SETUP** to return to the previous menu.

## Power On Volume

This sets the volume level the TV will use when it is turned on. By default, this is set to Last Volume (the level used before the TV was turned off).

1. Enter the Sound menu.
2. Press **▲** or **▼** to highlight **POWER ON VOLUME**.
3. Press **◀** or **▶** to select the desired number (0-100) or **LAST**.
4. Press **SETUP** to return to the previous menu. To exit, press **SETUP** until the programming menus disappear.

### Pillow Speaker Boost

This increases the audio output level when a pillow speaker is connected. It improves sound clarity and volume. Options include DISABLE, NORMAL, AND STRONG.

**NOTE:** Too much boost can cause audible distortion.

1. In the Sound menu, press ▲ or ▼ to highlight PILLOW SPEAKER BOOST menu and press OK to select it.
2. Press ▲ or ▼ to highlight your choice and press OK to enable it.

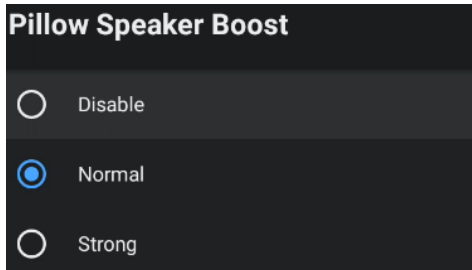

### Bass / Treble

This adjusts the balance of sound frequencies. Bass controls low-frequency sounds for deeper audio. Treble controls high-frequency sounds for clearer voices and sharper sound.

### Auto Volume

This automatically adjusts the TV's sound level to maintain a consistent volume. This helps reduce sudden changes in loudness between channels, programs, or commercials.

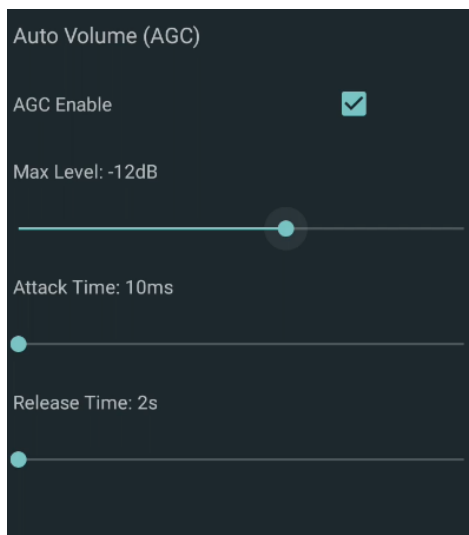

### Advanced Sound effects

Here, you can tweak virtual surround and audio source delay settings.

### Language

To change your system language:

1. Go to MENU.
2. Scroll down to LANGUAGE.
3. Choose your preferred language and Press OK.

Currently only English, French, German, and Italian are available.

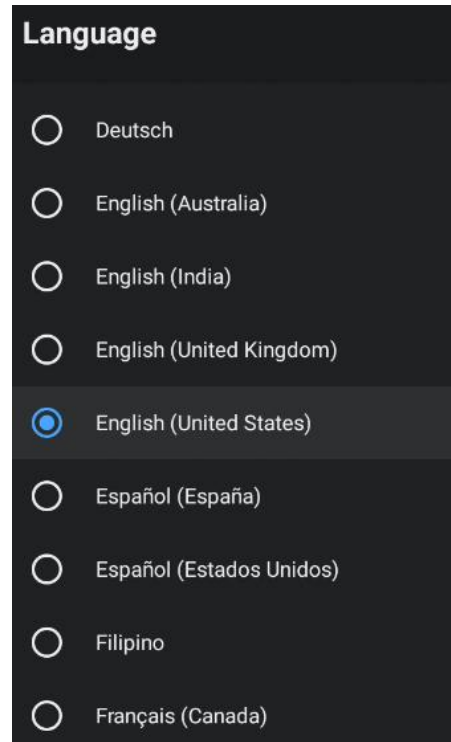

### A/V Sources

You can go to A/V Sources to manage and select where your TV gets audio and video signals from, including TV channels, HDMI devices, and media playback. You can enable or disable inputs to customize your source list.

1. Enter menu to open TV settings.
2. Scroll down to A/V SOURCES.
3. Click on any setting and enable or disable as desired.

### Source Enable

This allows you to enable or disable available input sources so they appear (or do not appear) in the TV's source list.

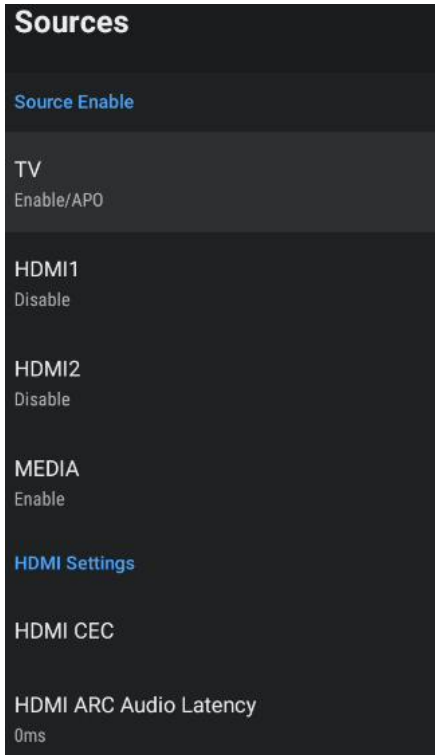

**TV:** This selects the built-in TV tuner for watching broadcast or cable channels.

**HDMI1 / HDMI2:** Inputs used to connect external devices such as cable boxes, streaming devices, game consoles, or Blu-ray players. These sources can be enabled or disabled in the source list.

**Media:** This allows playback of media files (such as videos, music, or photos) from a connected USB drive.

**HDMI CEC:** This allows compatible HDMI devices to control each other using a single remote control.

- **CEC Switch:** Enables the TV to control connected HDMI devices using a single remote.
- **Device Auto Power Off:** Turns off HDMI devices automatically when the TV is powered off.
- **TV Auto Power On:** Automatically turns on the TV when a connected HDMI device wakes up.
- **ARC/eARC:** Allows the TV to control audio return channel devices for improved audio transmission.
- **Audio Output Latency:** Adjusts audio delay to sync sound with video when using ARC/eARC devices.

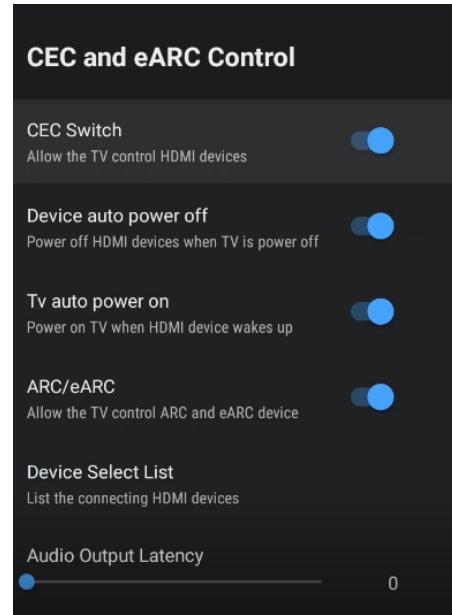

### HDMI ARC Audio Latency

This adjusts the audio delay when using HDMI ARC to synchronize sound with the video. The value is displayed in milliseconds (ms).

### Date & Time

This allows you to adjust your date, time, and timezone.

1. Press the TV SETUP button to bring up TV Options.
2. Press ► to highlight MENU and OK to select it.
3. Scroll down and select DATE & TIME.
4. Set your date and time and press OK.

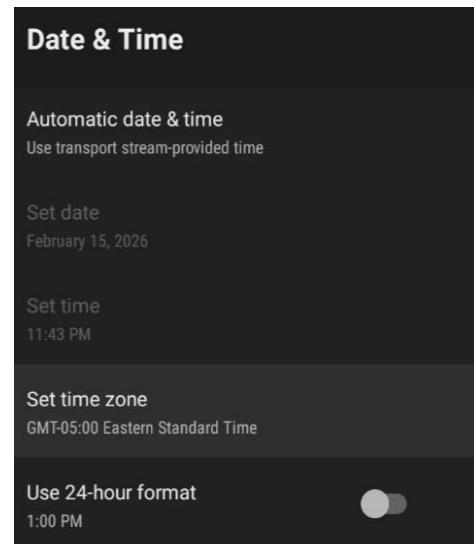

## FEATURES

The Features page allows you to configure advanced TV behavior and system options. These settings control how the TV powers on, how audio is delivered, and how content is routed between connected sources. **This section will only focus on popular settings under the Features menu.**

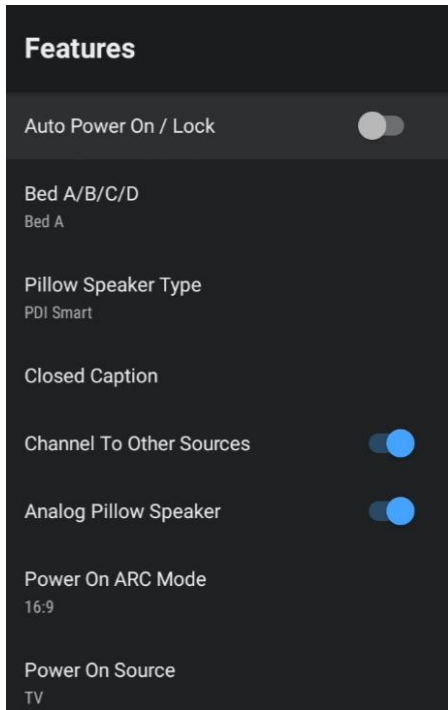

### Auto Power On / Lock

When enabled, the TV automatically powers on and locks to a predefined configuration.

To enable this setting:

1. Press the TV SETUP button to bring up TV Options.
2. Press ► to highlight MENU and OK to select it.
3. Scroll down and choose FEATURES.
4. Highlight AUTO POWER ON / LOCK and press OK.

### Bed A/B/C/D

This selects the bed location assigned to the TV. This setting is typically used in multi-bed environments to associate the TV with a specific patient bed.

1. Enter MENU and choose FEATURES.
2. Select Bed A/B/C/D.
3. Choose desired bed location.

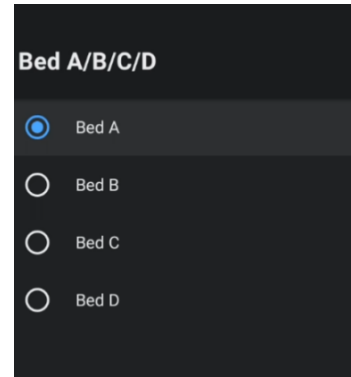

### Pillow Speaker Type

This defines the type of pillow speaker connected to the TV.

1. Enter MENU and choose FEATURES.
2. Select PILLOW SPEAKER TYPE.
3. Select PDi SMART or STANDARD.

### Analog Pillow Speaker

This enables support for analog pillow speakers. This allows the viewer to control basic TV functions (such as volume and channel) using a compatible pillow speaker device. ANALOG PILLOW SPEAKER is enabled by default. To disable.

1. Enter MENU and choose FEATURES.
2. Scroll down to ANALOG PILLOW SPEAKER and press OK to disable.

## SYSTEM SETTINGS

The Setup Menu allows you to set up the TV's internal operations.

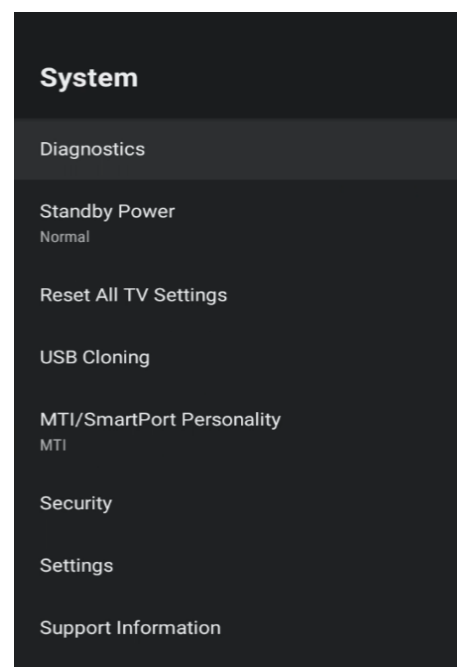

### DIAGNOSTICS

This is a display menu that provides readout of the TV's internal operations and version numbers.

Description of the diagnostics parameters:

**Model:** Model of television (Example: PDI-K24A, PDI-K32A, PDI-K43A)

**Firmware version:** The version that is running on the television (Example: 2.08)

**Boot version:** The boot version that is running on the television (Example: 2.3)

#### Power On Cause:

**Cold:** First time the television is turned on.

**CPU:** Restart from firmware update or changes to the "Pro:Idiom" setting.

**WatchDog:** Forced restart power on by boot controller.

If Standby Power is set to low, additional power on reasons may be displayed:

**Remote:** Power on with the IR remote.

**Front:** Button on the right side of the screen.

**Comm:** Power on through CCI.

#### Pro:Idiom diagnostic codes:

**OK:** Pro:Idiom channel is tuned and decoding properly.

**Missing ID:** Session ID missing - decryption disabled.

**Invalid key:** Invalid or corrupted key set.

**Stream Errors:** No encrypted stream present or checksum errors in stream.

**Non Pro:Idiom Ch:** TV is tuned to a non-Pro:Idiom channel.

**Disabled:** Pro:Idiom chip is disabled because TV is not set to "Free to Guest" and MTI is not connected.

**Not Supported:** Pro:Idiom chip is not present on this television.

#### CCI diagnostic codes:

**CCI Connected:** CCI port is connected to a host.

**Not connected:** CCI Port are enabled but are not connected to a host.

**Disabled:** CCI ports are disabled because Pro:Idiom is set to "Free to Guest".

**CCI Version:** Displays version of CCI protocol supported by the TV.

**Field ON Hours:** This displays how many hours that the television has been "ON".

**Field Powered Hours:** This displays how many hours the television had electrical power applied.

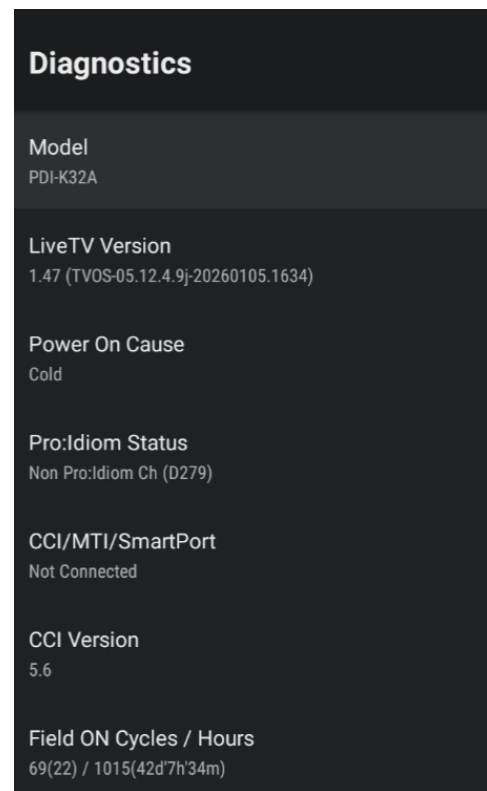

#### Standby Power

Low and Normal. Low will use less power in standby but will require several additional seconds to turn on.

#### Reset All TV settings

This menu will allow you to reset your TV app settings. After choosing this function, you will reach a confirmation screen. Press OK to begin the reset process. **(NOTE: This does not reset the TV to factory default settings).**

### Reset to Factory Default

To reset the TV to factory default settings:  
Go to MENU → SYSTEM → SETTINGS → DEVICE PREFERENCES → FACTORY MENU → FACTORY RESET.

OR

MENU → SYSTEM → SETTINGS → DEVICE PREFERENCES → ABOUT → FACTORY RESET.

### USB CLONING

Cloning allows quick programming of a TV from a USB flash drive. The operation involves first downloading setup data from a programmed host TV to a USB flash drive and then uploading the setup data to another TV. Cloning can also be used to re-program a programmed TV.

**NOTE:** For cloning operation, the “USB Media” source must be disabled, otherwise the Media menu appears instead of the desired Clone menu when using a blank USB drive.

## USB Cloning

Save Setting to USB

Restore Setting to TV

No clone files on USB

**NOTE:** Cloned files must be placed in a folder named PDITDF. To perform USB cloning:

1. Turn the TV on.
2. Insert a blank USB thumb drive (user provided) into either USB port on the TV.
3. Go to MENU → SYSTEM → USB CLONING.
4. Press ▲ or ▼ to highlight SAVE SETTING TO USB DISK.
5. Press ► to enter the SAVE SETTINGS TO USB menu. If you want to rename the file, you can do so with a USB keyboard -- otherwise go to step 11.
6. If you choose to rename, press the ▲ or ▼ to highlight the file name. Then press ◀ or ▶ to highlight each character.
7. Press ▲ or ▼ to change each character.
8. Repeat this process until you have the desired file name. Up to 8 characters may be used. **There can be no spaces in the filename.**
9. When done, press ◀ until the characters are no longer highlighted.
10. Press ▲ or ▼ to highlight SAVE.
11. Press ► to initiate.
12. Wait for the Cloning Main Menu to say “SETTING SAVED TO USB”, then press ◀ to go back to main menu.
13. Remove the USB Disk from the TV.

**Restore Setting to TV**

1. Turn the TV On.
2. Insert a flash drive with stored clone file (user provided) into either USB port.
3. When the Cloning Main Menu appears, press ▲ or ▼ to highlight RESTORE SETTING TO TV.
4. Press OK to initiate.
5. When the RESTORE SETTINGS TO TV menu appears, press ▲ or ▼ to highlight the appropriate settings file.
6. Press OK to initiate.
7. Wait for the Cloning Main Menu to reappear. You will get a confirmation screen.
8. The TV will restart after settings are restored.
9. Remove the USB Disk from the TV.
10. Verify correct setup of the TV.

**Security**

This allows menu password protection and the ability to change the password.

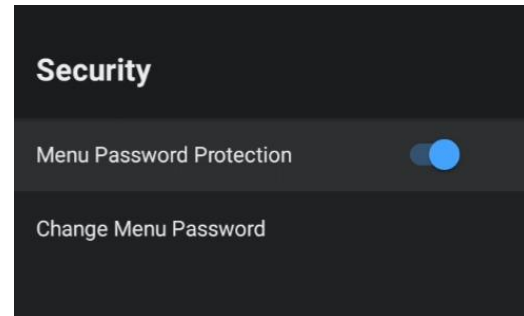
**Support**

This provides technical support contact information.

**FIRMWARE UPGRADE**

PDi periodically provides firmware updates for TVs. If you're notified that a new firmware update is available, follow these steps to upgrade your device:

1. Contact PDi for a USB flash drive with a zipped firmware package.
2. Insert the USB flash drive into either USB-A port on the TV.
3. Unplug your TV from power. Wait 5 seconds and plug it back in and turn it on. The firmware upgrade should begin.

**Configuration Section Complete**

At this point:

- ✓ Optimal picture quality achieved
- ✓ Channels configured correctly
- ✓ Clean audio output

## TROUBLESHOOTING TIPS

Analog pillow speaker problems	<ul style="list-style-type: none"> <li>• Confirm pillow speaker is securely plugged in</li> <li>• Connect the pillow speaker directly to the TV and verify that the across-room or bedside wiring is not faulted</li> <li>• Check fluorescent lighting is not causing interference with the TV's IR receiver</li> <li>• Check that the MTI port on the TV is disconnected (miswiring the MTI port can cause pillow speaker and IR problems).</li> </ul>
Pillow speaker not acting as expected (ie. press 2 but get a 5. )	<ul style="list-style-type: none"> <li>• Verify that the nurse call system has the correct Personality Block enabled</li> </ul>
Remote not working	<ul style="list-style-type: none"> <li>• Check batteries in remote</li> <li>• Check Bed A, B, C, D setup is correct</li> <li>• Check fluorescent lighting is not causing interference with the TV's IR receiver</li> <li>• Check that the MTI port on the TV is disconnected (miswiring the MTI port can cause pillow speaker and IR problems).</li> </ul>
TV channels up or turns off unexpectedly	<ul style="list-style-type: none"> <li>• In rare situations, fluorescent lighting reaching the IR receiver can cause erratic behavior</li> <li>• Disable analog pillow speaker</li> <li>• Relocate the TV away from the light source</li> <li>• Apply opaque tape over the IR sensor</li> </ul>
TV takes long time to turn on	<ul style="list-style-type: none"> <li>• Check standby power setting</li> </ul>
Pro:Idiom digital channels not showing up	<ul style="list-style-type: none"> <li>• Check Setup &gt; Channels &gt; Pro:Idiom</li> </ul>
CCI/MTI not working	<ul style="list-style-type: none"> <li>• Check Setup &gt; Channels &gt; Pro:Idiom</li> </ul>
PDi Qube will not turn on TV	<ul style="list-style-type: none"> <li>• Check standby power is set to normal</li> </ul>
No picture from external source	<ul style="list-style-type: none"> <li>• Make sure external source is connected properly</li> <li>• Confirm source is not being blocked by Parental Control setting</li> </ul>
Picture, but no sound	<ul style="list-style-type: none"> <li>• Check internal speaker is enabled</li> <li>• Confirm sound is not muted</li> <li>• Confirm no headphones are plugged in</li> <li>• If using an external source, confirm proper connection</li> </ul>
Clone menu does not appear	<ul style="list-style-type: none"> <li>• Verify "USB Media" source is disabled in Sources menu</li> </ul>

## LIMITED WARRANTY

PDi Communication Systems, Inc. ("PDi") standard warranty information is found at [pdiam.com](http://pdiam.com). For information regarding authorized servicing and all other information pertaining to this warranty, please contact PDi COMMUNICATION SYSTEMS, INC. at 40 Greenwood Ln, Springboro, Ohio 45066 or phone 800-628-9870 and ask for the PDi ProServices team.