



# medTV<sup>16</sup>

For model numbers beginning PDI-P16TV5

16" Arm-Mounted, Healthcare-grade  
LED Backlit HDTV

	MODEL:	Document Number: PD196-442R1
	<b>medTV16</b>  PDI-P16TV5 User Manual	

## Table of Contents

IMPORTANT SAFETY INSTRUCTIONS.....	5
INTRODUCTION.....	6
CABLING AND WIRING REQUIREMENTS .....	6
Installation Precautions.....	6
Coax Cable Specifications.....	6
Category Cable Specifications .....	6
INSTALLING AND REMOVING THE TELEVISION .....	6
Installing TV on Suspension Arm .....	6
Removing TV from Suspension Arm.....	7
DIRECT ENTRY KEYPAD .....	8
QUICK START GUIDE & POPULAR SETTINGS.....	8
Set Up Channels (RF).....	8
USB Cloning.....	8
Delete Channels from the Channel Map .....	9
Power On Channel .....	9
Speaker Enable/Disable.....	9
Enable/Disable Sources .....	9
Firmware Update – USB.....	9
Factory Reset/System Recovery.....	9
Change Menu PIN/Password.....	9
PROGRAMMING MENUS AND SETUP .....	10
RF TELEVISION SETTINGS.....	10
Accessing TV Settings.....	10
Accessing the Channel Setup menu.....	11
Service Level.....	11
Configure Channels .....	11
Channel Sources (Auto Program) .....	11
Channel Sequence.....	12
Power On Channel.....	12
Parental Controls.....	12
Channel Lock .....	12
CH Override/Auto Update.....	12
Auto Channel Alias .....	12
Accessing the TV Settings menu.....	13
Picture Settings .....	13
Sound Settings .....	14





	MODEL:	Document Number: PD196-442R1
	<b>medTV16</b>  PDI-P16TV5 User Manual	
		Page 3 of 17

- Internal Speaker ..... 14
- Minimum Volume ..... 14
- Maximum Volume..... 14
- Power on Volume..... 14
- Language Setting ..... 15
- Sources ..... 15
  - Source Enable..... 15
- Features ..... 16
  - Auto Power On/Lock ..... 16
  - Bed A/B/C/D..... 16
  - Channel to Other Sources ..... 16
  - Sleep Timer ..... 16
  - Menu Timer..... 16
- System..... 16
  - Diagnostics: ..... 16
  - Standby Power ..... 16
  - Reset All TV Settings..... 16
  - USB Cloning: ..... 17
  - MTI/SmartPort Personality ..... 17
  - Security ..... 17
  - Support Information ..... 17
- Limited Warranty..... 17



	MODEL:	<b>medTV16</b>	Document Number: PD196-442R1
	PDI-P16TV5 User Manual		Page 4 of 17

 This symbol indicates that dangerous voltage constituting a risk of electric shock is present within this unit.

 This symbol indicates that there are important operating and maintenance instructions in the literature accompanying this unit.

 **CAUTION**  
RISK OF ELECTRIC SHOCK,  
DO NOT OPEN!



**CAUTION: TO REDUCE THE RISK OF ELECTRIC SHOCK, DO NOT REMOVE COVER. NO USER SERVICEABLE PARTS INSIDE. REFER SERVICING TO QUALIFIED SERVICE PERSONNEL**



**Overhead Falling Hazard**

**WARNING:** To prevent injury, this apparatus must be securely attached to the floor/wall in accordance with the installation instructions.

TV can pose a striking hazard when mounted at an elevated position. Use only PDi mounting brackets, support arms, and appropriate hardware to assure TV will not fall from the mounted position.



**Rain and Moisture**

**WARNING:** To avoid the hazards of fire or electrical shock, DO NOT expose this television to rain or moisture.



**Oxygen Environment**

**WARNING:** Do not use in any oxygen tent or oxygen chamber. Such use may cause a fire hazard.

**Note to Cable TV Installer**

This reminder is provided to call the cable TV system installer's attention to Article 820-40 of the National Electrical Code. The code provides guidelines for proper grounding and in particular specifies that the cable ground shall be connected to the grounding system of the building, as close to the point of the cable entry as practical. Canadian installations shall be properly grounded in accordance with the Canadian Electrical Code, Part 1.

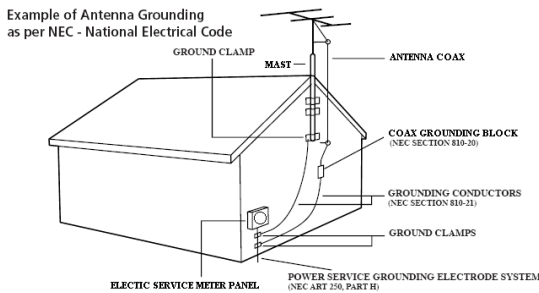

**FCC**

This equipment has been tested and found to comply with the limits for a Class A digital device, pursuant to part 15 of the FCC Rules. These limits are designed to provide reasonable protection against harmful interference when the equipment is operated in a commercial environment. This equipment generates, uses, and can radiate radio frequency energy and, if not installed and used in accordance with the instruction manual, may cause harmful interference to radio communications. Operation of this equipment in a residential area is likely to cause harmful interference in which case the user will be required to correct the interference at his own expense.

**Maintenance and Servicing**

The TV does not require periodic maintenance other than cleaning. Never remove the back cover of the TV; this can expose you to high voltage and other hazards. If the TV does not operate properly, unplug it, and call an authorized service center or PDi.

**Cleaning and Disinfection**

Clean the exterior of this television by removing dust with a lint-free cloth. Spot test a new disinfectant by test cleaning a non-obvious small spot on the TV's back cabinet, keypad, and LCD panel. PDi recommends using a premoistened disinfectant cloth, like PD600-001 Super Sani-Cloth or similar, or spraying cleaner onto a dry cloth and then wiping the unit. Specific recommendations can be found at [www.pdiarm.com](http://www.pdiarm.com). **CAUTION:** To avoid damage to the surface of the television, do not use abrasive or chemical cleaning agents.

**Product Modification**

Do not attempt to modify this product in any way without written authorization. Unauthorized modification could void the user's authority to operate this product.

**Copyright, Trademarks**

© 2024 PDi Communication Systems, Inc. All rights reserved. PDi®, medTV® and medTAB® are registered trademarks of PDi Communication Systems, Inc. Manufactured under license from Dolby Laboratories. Dolby, Dolby Audio, and the double-D symbol are trademarks of Dolby Laboratories Licensing Corporation. The terms HDMI, HDMI High-Definition Multimedia Interface, and the HDMI Logo are trademarks or registered trademarks of HDMI Licensing Administrator, Inc. Product logos, brands and other trademarks displayed within PDi's products are the property of their respective trademark holders, who are not affiliated with, endorsing, or sponsoring PDi Communication Systems, Inc. or our products.

**Underwriters Laboratories**

This model Hospital Grade LED HDTV is a specialized TV and should be installed to National Electrical Code specifications. This device is safety tested and listed by the Underwriters Laboratories as a product suitable for use in healthcare facilities in both the United States and Canada.



**Disclaimer**

The author and publisher have used their best efforts in preparing this manual. PDi Communication Systems, Inc. makes no representation or warranties with respect to the accuracy or completeness of the contents of this manual and specifically disclaims any implied warranties or merchantability or fitness for any purpose and shall in no event be liable for any loss of profit or any other damages. The information contained herein is believed accurate, but is not warranted, and is subject to change without notice or obligation accurate, but is not warranted, and is subject to change without notice or obligation.





	MODEL:	Document Number:
	<b>medTV16</b>	
PDI-P16TV5 User Manual		Page 5 of 17



### IMPORTANT SAFETY INSTRUCTIONS

**CAUTION: THIS INSTALLATION SHOULD BE MADE BY A QUALIFIED SERVICE PERSON AND SHOULD CONFORM TO ALL LOCAL CODES. READ AND FOLLOW THE SAFETY INSTRUCTIONS BEFORE ATTEMPTING THIS INSTALLATION.**

1. Read Instructions – All the safety and operating instructions should be read before the product is operated.
2. Keep these Instructions – The safety and operating instructions should be retained for future reference.
3. Heed all Warnings – All warnings on the product and in the operating instructions should be adhered to.
4. Follow all Instructions – All warnings on the product and in the operating instructions should be followed.
5. Water and Moisture – Do not expose this product to rain or moisture. Do not use this product near water – for example, near a bath tub, wash bowl, kitchen sink, or laundry tub; in a wet basement; near a swimming pool; and the like.
6. Cleaning – Please see specific recommendations under “Cleaning and Disinfection” on previous page.
7. Ventilation – Slots and openings in the cabinet are provided for ventilation to ensure reliable operation of the product and to protect it from overheating. These openings must not be blocked or covered. The openings should never be blocked by placing the product on a bed, sofa, rug, or other similar surface. This product should not be placed in a built-in installation such as a bookcase or rack unless proper ventilation is provided, or the manufacturer’s instructions have been adhered to.
8. Heat – The product should be situated away from heat sources such as radiators, heat registers, stoves, or other products (including amplifiers) that produce heat.
9. Power-Cord Protection – Protect the power cord from being walked on or pinched, particularly at plugs, convenience receptacles, and the point where they exit from the product.
10. Attachments – Only use attachments/accessories specified by the manufacturer.
11. Use only with cart, stand, tripod, bracket, or table specified by the manufacturer, or sold with the apparatus. When a cart is used, use caution when moving the cart/apparatus combination to avoid injury from tip-over.
12. Lightning – For added protection for this product during a lightning storm, or when it is left unattended and unused for long periods of time, unplug it from the wall outlet and disconnect the antenna or cable system. This will prevent damage to the product due to lightning and power-line surges.
13. Servicing – Refer all servicing to qualified service personnel. Servicing is required when the apparatus has been damaged in any way, such as power cord or plug is damaged, liquid has been spilled or objects have fallen into the apparatus, the apparatus has been exposed to rain or moisture, does not operate normally, or has been dropped.
14. Oxygen Environment – Do not use in an oxygen tent or oxygen chamber. Such use may cause a fire hazard.
15. To prevent injury, this apparatus must be securely attached to the wall in accordance with the installation instructions. TV’s can pose a striking hazard when mounted at an elevated level.
16. Power Sources – This product should be operated only from the type of power source indicated on the marking label. If you are not sure of the type of power supply to your home, consult your product dealer or local power company. For products intended to operate from battery power, or other sources, refer to the operating instructions.



	Ce symbole indique qu'une tension dangereuse constituant un risque de choc électrique est présente dans cet appareil.
	Ce symbole indique qu'il existe des instructions d'utilisation et d'entretien importantes dans la documentation accompagnant cet appareil.

	<b>AVERTISSEMENT</b>	
RISQUE DE CHOC ELECTRIQUE, NE PAS OUVRIR!		
AVERTISSEMENT: AFIN DE REDUIRE LE RISQUE DE CHOC ELECTRIQUE, NE PAS RETIRER LE COUVERCLE. L'APPAREIL NE CONTIENT AUCUN COMPOSANT SUSCEPTIBLE D'ETRE REPARÉ PAR L'UTILISATEUR. CONFIER L'ENTRETIEN A DU PERSONNEL QUALIFIE		

### CONSIGNES DE SÉCURITÉ IMPORTANTES

**CETTE INSTALLATION DOIT ÊTRE EFFECTUÉE PAR UN TECHNICIEN QUALIFIÉ ET DOIT ÊTRE CONFORME À TOUS LES CODES LOCAUX. LIRE ET SUIVRE LES CONSIGNES DE SÉCURITÉ AVANT DE PROCÉDER À L'INSTALLATION.**

1. Lire ces instructions.
2. Conserver ces instructions.
3. Respecter tous les avertissements.
4. Suivre toutes les instructions.
5. Ne pas utiliser cet appareil près de l'eau - par exemple près d'une baignoire, d'un lavabo, dans un sous-sol humide, ou près d'une piscine ou similaire.
6. Veuillez voir les recommandations sous “Nettoyage et Désinfection” à la Page précédente.
7. Ne pas obstruer les ouvertures de ventilation. Installer conformément aux instructions du fabricant. Les ouvertures ne doivent jamais être obstruées en plaçant le produit sur un lit, un canapé, un tapis ou toute autre surface similaire.
8. NE PAS installer près de sources de chaleur telles que radiateurs, registres de chaleur, poêles ou tout autre appareil (y compris les amplificateurs) qui produit de la chaleur.
9. NE PAS neutraliser le dispositif de sécurité de la fiche polarisée ou de terre. Ce produit est équipé d'une prise de terre à trois fils, une fiche ayant une troisième broche (mise à la terre). Cette fiche ne peut s'insérer que dans une prise de courant avec mise à la terre. Il s'agit d'une caractéristique de sécurité. Si vous êtes incapable d'insérer la fiche dans la prise, contacter votre électricien pour remplacer votre prise obsolète.
10. Protéger le cordon d'alimentation pour qu'il ne soit pas piétiné ni pincé, en particulier au niveau des fiches, des prises de courant et au point de sortie de l'appareil.
11. Accessoires - Utiliser uniquement les attaches/accessoires recommandés par le fabricant.
12. Utiliser uniquement avec un chariot, stand, trépied, support ou table recommandé par le fabricant ou vendu avec l'appareil. Lorsqu'un chariot est utilisé, faire attention lors du déplacement de l'ensemble chariot/appareil afin d'éviter des blessures en cas de basculement.
13. Débrancher cet appareil en cas d'orages ou lorsqu'il reste inutilisé pendant de longues périodes.
14. Confier toute réparation à un personnel de service qualifié. Des réparations sont nécessaires si l'appareil est endommagé d'une façon quelconque, par exemple : cordon ou prise d'alimentation endommagé, liquide renversé ou des objets sont tombés dans l'appareil, l'appareil a été exposé à la pluie ou à l'humidité, ne fonctionne pas normalement ou s'il est tombé.
15. Sources d'alimentation - Ce produit doit être utilisé uniquement à partir du type de source d'alimentation indiqué sur l'étiquette. Si vous n'êtes pas sûr sur le type d'alimentation de votre domicile, consultez le détaillant de votre produit ou la compagnie d'électricité locale. Pour les produits proposés de fonctionner par piles, ou autres sources d'alimentation, reportez-vous aux consignes d'utilisation.
16. Environnement d'oxygène - Ne pas utiliser sous une tente à oxygène ou chambre à oxygène. Une telle utilisation peut causer un risque d'incendie.





	MODEL:	<b>medTV16</b>	Document Number: PD196-442R1
		PDI-P16TV5 User Manual	Page 6 of 17

## INTRODUCTION

This television is specifically designed for entertainment purposes for use in a hospital, nursing home, medical care center, or similar healthcare setting. The medTV16 personal patient television delivers a simple, easy to use TV experience.

## CABLING AND WIRING REQUIREMENTS

### Installation Precautions

For models powered over coax, use only a power source from PDi suitable for use in a healthcare facility. The single coaxial cable out the top of the TV is used to supply both low voltage AC or DC power (28VAC or 24VDC) and RF signal to the television.

For models powered by ethernet (PoE) use only UL listed power sourcing equipment that offers at least 60W per port using all 4 pairs for power delivery. This is sometimes called **UPoE, PoE++** or **802.3bt type 3**. PDi recommends the **Microchip Microsemi PD-9506G/ACDC/M** midspan power inserter. In devices ordered with Power over Ethernet, the ethernet cable on top of the TV is used to supply both power and data. Be sure power is not applied to the coaxial cable entering the TV.

### Coax Cable Specifications

When using a central power supply, cable selection is crucial. Due to long coax cable runs encountered in hospital installations, coax cable employing a solid copper center conductor and copper shield is required. Cable run lengths **MUST NOT** exceed 150 feet. Required coaxial cable numbers include Alpha M4182 (replaced Alpha 9804C) (non-plenum), Belden 9248 (non-Plenum), West Penn 806 (non-Plenum), or West Penn 25806 (Plenum), which have been tested with coax-powered TVs.

### Category Cable Specifications

PoE models are IEEE 802.3bt compatible. When using a PoE power inserter to apply power to ethernet, you may run up to 328 feet of CAT5e (or better).

## INSTALLING AND REMOVING THE TELEVISION

### Installing TV on Suspension Arm

This television is designed to attach to a PDi suspension arm capable of supporting a television weighing 7 pounds (medTAB16, medTV16). See Document PD196-428 Arm Mounted PDi TV Installation Instructions for additional details.

1. Remove the 3/4" socket head cap screw (PDISHCS252075) and the retaining washer (PD220-002) from the retainer plate of the TV. Discard the washer and place socket head cap screw to the side.
2. Slide the TV onto the end of the arm so that the retainer plate rests on top of the arm nose and the hole in the retainer plate aligns with the hole in the arm nose.
3. Secure the television into place with the 3/4" socket head cap screw from step 1.
4. Remove the safety pin from the safety brake pin hole. Store the safety pin in the nose of the arm for easy access during TV removal.
5. Connect cables and secure arm cover kits.

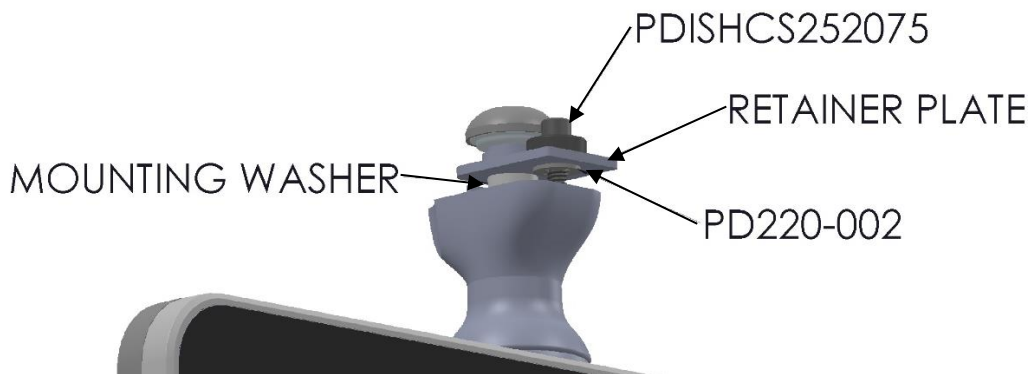

	MODEL: <p style="text-align: center;"><b>medTV16</b></p>	Document Number: PD196-442R1
	PDI-P16TV5 User Manual	Page 7 of 17

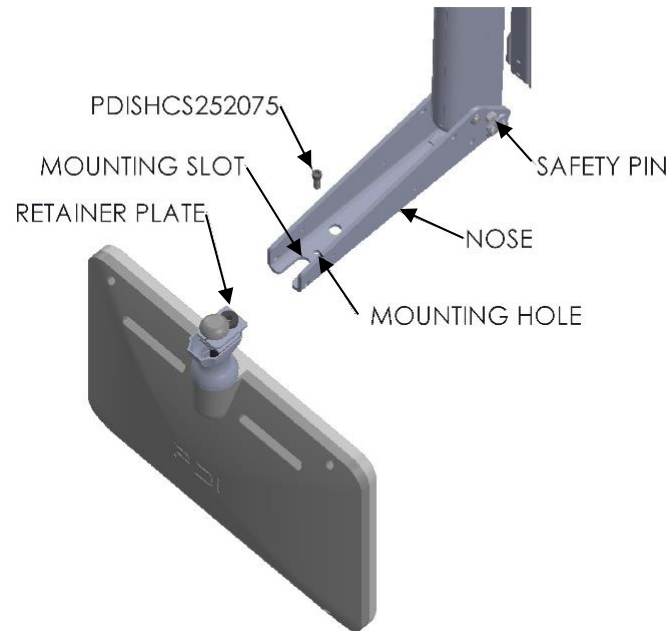

**Arm Recoil Hazard:** The safety brake pin must remain in the SAFETY BRAKE PIN HOLE whenever the television is removed from the arm or when the arm is removed from the wall bracket to prevent INJURY from the arm springing open.

### Removing TV from Suspension Arm

To remove the TV from the arm:

1. Remove plastic arm cover kits from the nose of the arm.
2. Find the safety pin stored in the nose of the arm. If unable to find the safety pin, contact PDi for a replacement before proceeding.
3. Place the safety pin in the safety brake pin hole.
4. Remove the  $\frac{3}{4}$ " socket head cap screw, disconnect the cables, and slide the TV off the arm nose. Note: the  $\frac{3}{4}$ " socket head cap screw is the **only** hardware that will need to be loosened or removed when removing a PDi TV from a PDi suspension arm.

	MODEL:	<b>medTV16</b>	Document Number: PD196-442R1
	PDI-P16TV5 User Manual		Page 8 of 17

## DIRECT ENTRY KEYPAD

You can use the glass keypad for power, volume, closed captions, channel, and direct channel entry.

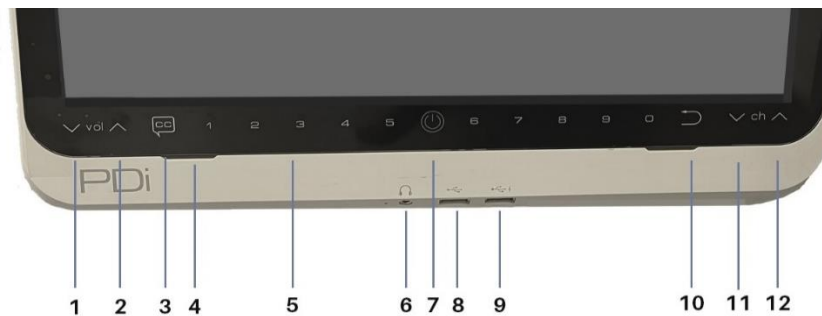

- |                     |                          |
|---------------------|--------------------------|
| 1. Volume down      | 7. Power button          |
| 2. Volume up        | 8. USB                   |
| 3. Closed caption   | 9. USB with quick charge |
| 4. Speakers         | 10. Last                 |
| 5. Direct entry 1-0 | 11. Channel down         |
| 6. Headphone jack   | 12. Channel up           |

## QUICK START GUIDE & POPULAR SETTINGS

Note: Access to the setup menus requires a PDI Programmer Remote, PD108-520. This remote is not included with each TV and must be ordered separately. Navigate all TV menus by pressing TV SETUP on the PD108-520 remote and then using the arrow buttons, back button, and OK button on the remote.

### Set Up Channels (RF)

Auto Program (or Channel Scan) the TV to load the TV channels to the TV's channel map.

1. Press TV SETUP on PD108-520 remote -> Channel Setup -> Channel Sources
2. Select PDi TvInput, change settings if needed.
3. Select Auto Scan button. Note: auto scan can take several minutes to complete
4. Select Done when Auto Scan is complete.

See RF TELEVISION SETTINGS section for more detailed information.

### USB Cloning

Once you have a PDi TV configured the way you want, you can copy these setting configurations to other PDi TVs. USB Cloning copies most of the TV settings, including: channel scan/map, power on channel/volume, channel aliases, min/max volume, source settings. It is best practice to begin with a blank USB drive that is free from any other files.

On the TV you have set-up and configured that you want to copy the settings from:

1. Press TV SETUP on PD108-520 remote -> Menu -> System -> USB Cloning
2. Insert USB drive into either USB-A port on front of device.
3. Select Save Setting to USB

On the TV you want to copy the settings to:

1. Press TV SETUP on PD108-520 remote -> Menu -> System -> USB Cloning
2. Insert USB drive from the step 3 above into either USB-A port on front of device.
3. Select Restore Setting to TV. If no USB drive is found, this option will not be available.
4. From the Restore Setting option, select the file name that you saved your configuration.



	MODEL:	Document Number:
	<b>medTV16</b>	
PDI-P16TV5 User Manual		Page 9 of 17

### Delete Channels from the Channel Map

1. Press TV SETUP on PD108-520 remote -> Channel Setup -> Configure Channels
2. Remove blue checkmarks next to the channel to be deleted for every service level applicable by and pressing **1** to assign/unassign that channel to the Free service level, pressing **2** to assign/unassign that channel to the Basic service level, and pressing **3** to assign/unassign that channel to the Premium service level. You will want to go through Auto Program prior to using this setting.

### Power On Channel

1. Press TV SETUP on PD108-520 remote -> Channel Setup -> Power On Channel
2. Select the applicable Service Level (Free Basic, Premium)
3. Select Last Channel or the specific channel desired.

### Speaker Enable/Disable

1. Press TV SETUP on PD108-520 remote -> Menu -> Sound -> Internal Speaker
2. Check marks next to a source indicate internal speakers are enabled for that source. Uncheck the boxes to disable speakers for a specific source by pressing the OK button on the PD108-520 remote.

### Enable/Disable Sources

1. Press TV SETUP on PD108-520 remote -> Menu -> Sources
2. Select each source to change setting between Disable, Enable/APO (auto-power-on), Enable/NoAPO (auto-power-on)

### Firmware Update – USB

The firmware is field upgradeable, but normally does not require this process and should be performed by the hospital technician. Once complete, the TV settings must be reprogrammed. A special data file is required from the PDi factory to complete this process by USB. Firmware files are written to the root directory of a blank USB Flash Drive. Disconnect power from the device. While in a no-power state, insert USB drive to front USB-A port. Then connect power. TV will update. Be sure to remove the USB drive when the update is complete. Once complete, the TV settings must be reprogrammed.

### Factory Reset/System Recovery

1. Press TV SETUP on PD108-520 remote.
2. Menu -> System -> Settings -> Device Preferences -> About -> Factory reset
3. Confirm your desire to restore to factory settings
4. Device will reboot.

### Change Menu PIN/Password

1. Press TV SETUP on PD108-520 remote.
2. Menu -> System -> Settings -> Security -> default PIN “45066” OK
3. Enable menu password protection or change menu password. Note: If the PIN is changed and forgotten, it cannot be recovered. Factory reset will be required.

### Closed Captions

For a user to navigate Closed Captions without a remote, use the channel up/down keys on the TV to navigate to the desired closed caption setting. Then use vol up/down to select the setting.



	MODEL:	<b>medTV16</b>	Document Number: PD196-442R1
	PDI-P16TV5 User Manual		Page 10 of 17

## PROGRAMMING MENUS AND SETUP

**Note:** The following instructions assume you have a programming remote, have correctly mounted the TV, and connected a coax cable that provides both power and RF signal. The PDi programming remote Part Number PD108-520 must be ordered separately.

If the SETUP screen times out while you are changing any settings, simply press SETUP on the PD108-520 remote.

## RF TELEVISION SETTINGS

### Accessing TV Settings

To set up your RF television channels or to make changes to the television settings, press TV SETUP on the PD108-520 remote. Navigate settings menus with the remote's arrow keys, back button, and OK button.

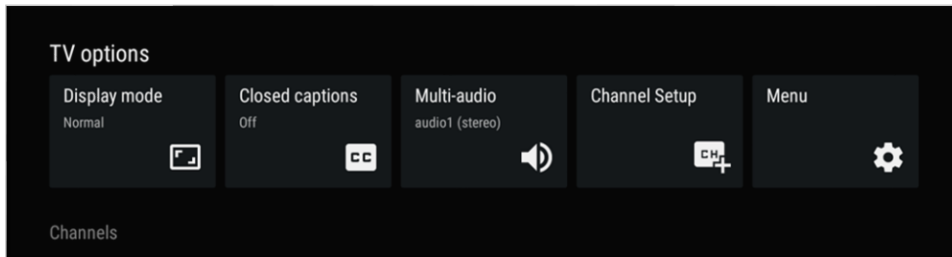

**Display Mode** (Aspect Ratio) allows you to change the aspect ratio of the TV app.

**Closed Captions** allows you to turn closed captions on and to change the font size and style of closed captions. To navigate through Closed Captions without a remote, use the channel up/down keys on the TV to navigate to the desired setting. Then use vol up/down to select the setting.

**Multi-audio / SAP Audio.** Not enabled on this product

	MODEL:	Document Number:
	<b>medTV16</b>	
PDI-P16TV5 User Manual		Page 11 of 17

## Channel Setup

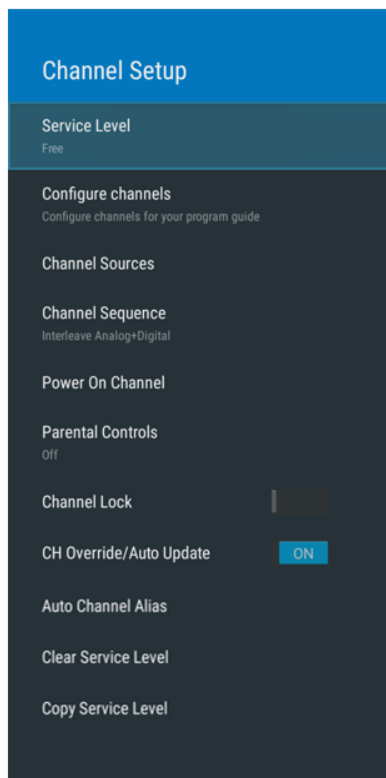

### Accessing the Channel Setup menu

1. Press TV SETUP on PD108-520 remote.
2. Select Channel Setup

**Service Level:** This TV offers three different programmable service levels: Free, Basic, and Premium. Only one service level is usable at a time on an individual TV.

**Configure Channels:** This setting allows you to assign channels to one or more service levels. **F** (Free) **B** (Basic) **P** (Premium). Navigate up/down to the channel desired and press **1** on the PD108-520 remote to assign/unassign that channel to the Free service level, press **2** to assign/unassign that channel to the Basic service level, and press **3** to assign/unassign that channel to the Premium service level. You will want to go through Auto Program prior to using this setting.

**Channel Sources (Auto Program):** This setting is where you'll find the Auto Program (or Channel Scan) feature. During Auto Program, the TV scans each available channel for activity. Channels that display activity are memorized into the selected Service Level.

From the Channel Setup menu:

1. Select Channel sources to open the "Set up your sources" menu
2. Select PDiTVInput

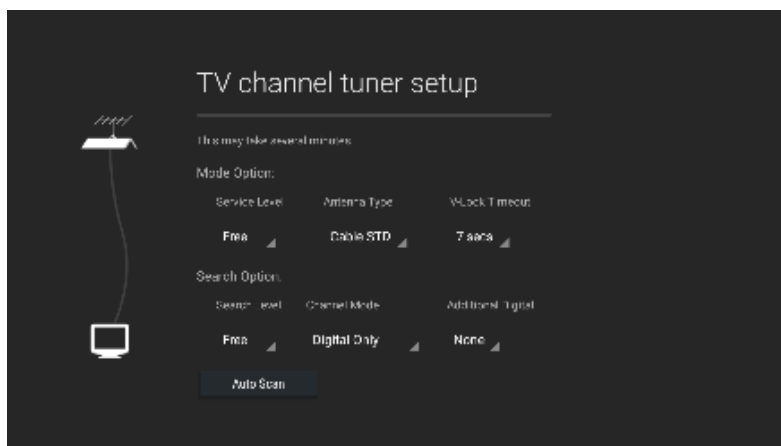

### Mode Option Settings:

3. Set the Antenna Type (**Air or Cable**) depending upon the healthcare facility's signal style.
4. Leave V-Lock Timeout at **7 secs**. The V-Lock Timeout feature is provided to adjust the dwell time at each frequency as the auto-program scans for a valid signal.

### Search Option Settings:

5. Set the Search Level you are programming (**Free, Basic, Premium**).
6. Set the Channel Mode (**Analog Only, Digital Only, or Analog and Digital**) depending upon the healthcare facility's signal style.
7. Set Additional Digital (**None or Air**) depending on the healthcare facility's signal style.
8. Press Auto Scan button. Note: auto scan can take several minutes to complete
9. Press Done when Auto Scan is complete.

	MODEL:	Document Number:
	<b>medTV16</b>	
PDI-P16TV5 User Manual		Page 12 of 17

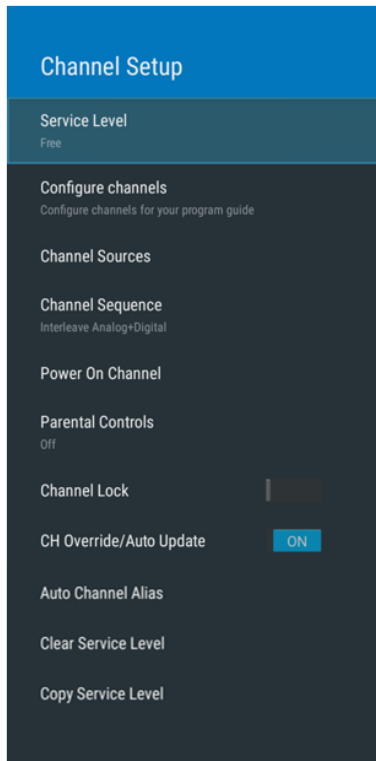

**Channel Sequence:** If the facility has both analog and digital channels, this setting allows you to set the order in which they will appear in the channel line up, all Analog then Digital or Interweave Analog+Digital. Select based on facility preference. The default setting is All Analog then Digital.

**Power On Channel:** Set the TV to power on to a specific channel or to the Last Channel that was on when the TV turned off. Power On Channel can be set for each Service Level so long as the Service Level has channels. This feature is useful for hospitals that have a Welcome Channel and wish to have it displayed upon initial use of the TV. The patient can then tune to any other available channel.

From the Channel Setup menu:

1. Select Power On Channel
2. Select the Service Level (Free Basic, Premium)
3. Select Last Channel or the specific channel desired. Note, if the selected Service Level shows only Last Channel and no list of channels, that Service Level has no channels assigned to it. Add channels to the Service Level through the Configure Channels menu.

**Parental Controls:** Parental controls provide the ability to block channels or to block programs based on their rating. The default setting is off. To enable parental controls, From the Channel Setup menu:

1. Select Parental Controls
2. Create a PIN and confirm your PIN. The PIN can be changed but the prior PIN is required to change the PIN. If you forget your PIN, you will need to clear TV Settings by pressing TV SETUP on PD108-520 remote -> Menu -> System -> Reset All TV Settings. TV will reboot. This will clear all TV Settings.
3. Turn Parent Controls ON by pressing the OK button to toggle the setting switch.
4. Channels Blocked menu lets you block entire channels from the TV.
5. Program Restrictions by Rating. Choose the desired Rating System to reduce the number of available options in step 6. Canada, Canada (French), United States, United States (Fim ratings) populate by default. Additional rating systems are available by pressing "See all rating systems".
6. Block Ratings menu blocks programs by their rating so long as this information is available from the TV signal source. This can be set based on general settings (High, Medium, Low) or can be set manually through the Custom menu.

**Channel Lock:** This feature allows you to fix the TV to a specific channel. For example, this feature may be used if the TV is in a common area. With the TV tuned to the desired channel, navigate to the Channel Setup menu. Go to Channel Lock menu item and toggle Channel Lock switch to ON. To remove the channel lock, toggle channel lock switch again.

**CH Override/Auto Update:** CH Override allows any channel to be entered using the TV's or the remote's number pad, even if the channel is not memorized in the current Service Level. Toggle the switch by pressing OK on the remote to turn Channel Override On/Off. Note: the channel must have enough signal strength to be detected by the TV firmware to be added to the existing channel map.

**Auto Channel Alias:** This setting automatically assigns a sequential channel number to the channels in the list. Select the appropriate option: Fill Analog Gaps with Digital Channels, Renumber Only Enabled Channels, Renumber All Channels, or Remove All Aliases. You will be asked to confirm your selection.

**Clear Service Level:** This setting clears the channel map for the specified service.

**Copy Service Level:** This setting copies the channel map from one service level to another service level (ie Free copied to Basic).



	MODEL:	Document Number:
	<b>medTV16</b>	
PDI-P16TV5 User Manual		Page 13 of 17

## TV Settings

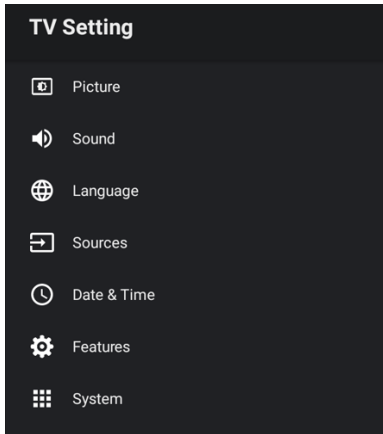

### Accessing the TV Settings menu

1. Press TV SETUP on PD108-520 remote.
2. Select Menu

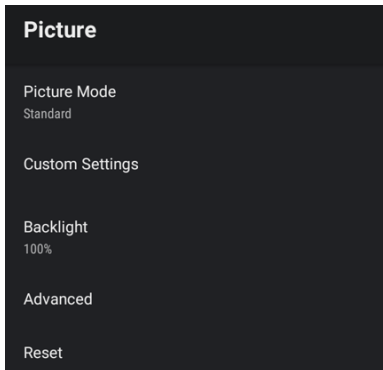

### Picture Settings

**Picture Mode:** The default is standard picture mode. Or you can change to Vivid, Soft, Sports, Movie, or User. User mode allows you to manually adjust picture settings through the custom settings menu where you can manually adjust brightness, contrast, saturation, sharpness, and Hue. All are defaulted to 50%.

**Backlight:** Changes the brightness of the display 0-100%. Default is 100%

**Advanced:** provides access to additional settings such as color temperature, DNR, DeBlock etc. It is rare that these settings will need to be adjusted.

**Reset:** lets you default all picture settings back to factory defaults

	MODEL:	Document Number:
	<b>medTV16</b>	
PDI-P16TV5 User Manual		Page 14 of 17

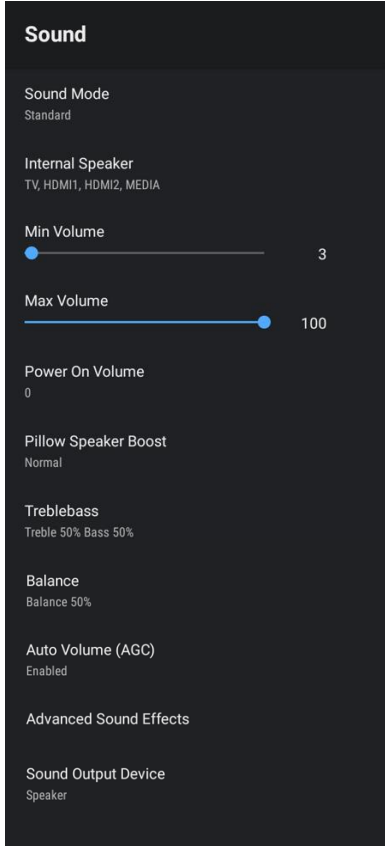

### Sound Settings

From the Sound menu, you can customize the speaker settings. This allows you to set max volume levels, disable internal speakers, etc.

**Sound Mode:** The default is standard sound mode, or you can change to Music, News, Movie, Game, User. User mode allows you to manually adjust five band settings. All are defaulted to 50%.

**Internal Speaker:** The TV's internal speakers can be enabled or disabled requiring the use of a headphone for private listening. This option is commonly used in dialysis clinics and multiple occupancy rooms. Speakers can be enabled/disabled by individual TV source (TV, HDMI1, HDMI2, MEDIA). With the OK button on the remote, check or uncheck the boxes next to the sources/inputs for which you want the internal speakers disabled. To ensure the speakers are always disabled, uncheck all boxes.

**Minimum Volume:** Sets the minimum volume level the unit can reach. Setting this to any value other than 0 guarantees that some level of sound will always be heard when the TV is operating. Use the left/right arrow keys on the PD108-520 remote to adjust volume from 0 to 100.

**Maximum Volume:** Sets the maximum volume level the TV can reach. Use the left/right arrow keys on the PD108-520 remote to adjust volume from 0 to 100.

**Power on Volume:** Sets the initial volume for the TV upon powering on. Options include "Use last volume" or "Set volume" to manually set the power on volume level. Once the TV is on, the volume can be set to any allowable level. NOTE: If Power on Volume is set to LAST, and physical power is removed (ie. a power outage), the TV will power on with a volume of zero.

**Pillow Speaker Boost:** Defaulted to Normal, can be changed to Disabled or Strong.

**Treblebass:** Adjust Treble and Bass. Both default to 50%.

**Balance:** Adjust speaker volume left to right.



	MODEL:	<b>medTV16</b>	Document Number: PD196-442R1
	PDI-P16TV5 User Manual		Page 15 of 17

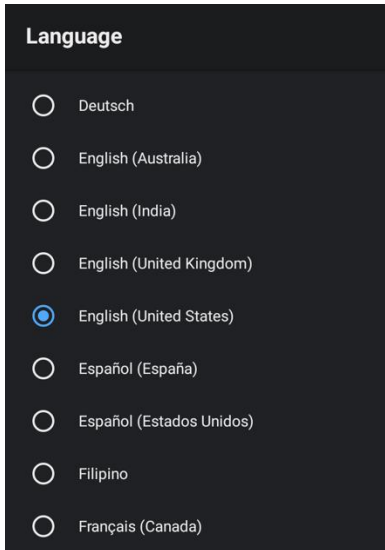

### Language Setting

Language settings apply to the system menus only. More than 40 languages available

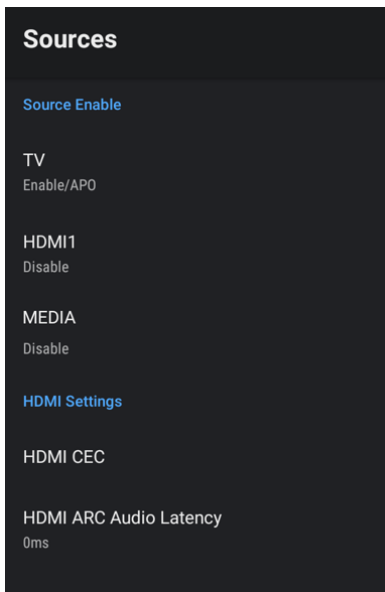

### Sources

**Source Enable:** If you ordered your TV with optional HDMI input, this menu is where you will enable the source. Each source can be set to Disable, Enable/APO (auto-power-on), Enable/No APO (auto-power-on).

**NOTE:** Please disable all TV sources that are not in use. A TV that is switched to a non-connected source generates nuisance hospital maintenance calls of TV Not Working, when in fact the TV does work, but has been set to an inactive source.

**HDMI CEC and ARC settings:** Enable and adjust HDMI CEC settings and ARC control through the HDMI CEC and HDMI ARC Audio Latency menus under the Sources Menu.



	MODEL:	Document Number:
	<b>medTV16</b>	
PDI-P16TV5 User Manual		Page 16 of 17

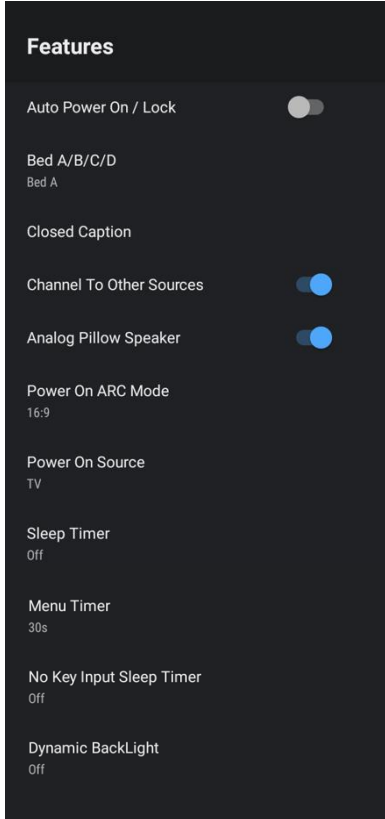

## Features

**Auto Power On/Lock:** If enabled, user cannot turn the device off. This feature is useful for controlling the TV from a wall switch or preventing the TV from being turned off by the TV power button or the remote control.

**Bed A/B/C/D:** The TV offers selectable codes Bed A, Bed B, Bed C, and Bed D for independent control of a single television in a multi-television room.

**Pillow Speaker Type:** Select Standard or PDI Smart (with navigation arrows).

**Channel to Other Sources:** When enabled, user will be able to access HDMI sources through the TV channel line up.

**Sleep Timer:** TV will auto power off after the set amount of time, 10 minutes to 8 hours.

**Menu Timer:** Set-up menus will automatically close after the defined amount of time. This feature can be disabled or the default 30 seconds can be changed from 15 seconds to 240 seconds

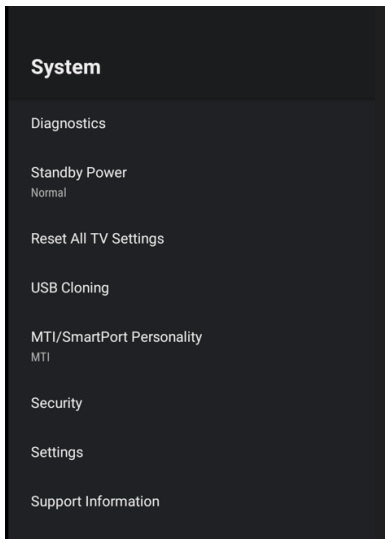

## System

**Diagnostics:** This menu provides information on the TV's internal operation including power on cause, CCI version, TV version, and hours on. The Diagnostics items are read-only and cannot be changed.

Field On Hours: Cumulative time TV is actually on.  
Field Powered Hours: Cumulative time TV is powered.

**Standby Power:** Normal or Low. Device will take longer to boot up if in low power mode.

**Reset All TV Settings:** Clears TV settings to factory settings. To factory reset the entire television, press TV SETUP on PD108-520 -> Menu -> System -> Settings -> Device Preferences -> About -> Factory reset



	MODEL:	Document Number: PD196-442R1
	<b>medTV16</b>  PDI-P16TV5 User Manual	
		Page 17 of 17

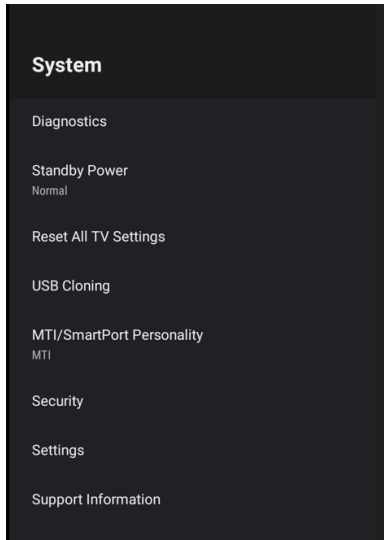

**USB Cloning:** Once you have a PDi TV configured the way you want, you can copy these settings to other PDi TVs. USB Cloning copies most of the TV settings, including: channel scan/map, power on channel/volume, channel aliases, min/max volume, source settings. It is best practice to begin with a blank USB drive that is free from any other files.

On the TV you have set-up and configured that you want to copy the settings from:

1. Press TV SETUP on PD108-520 remote
2. Menu -> System -> USB Cloning
3. Insert USB drive into either USB-A port on front of device
4. Select Save Setting to USB

On the TV you want to copy the settings to:

1. Press TV SETUP on PD108-520 remote
2. Menu -> System -> USB Cloning
3. Insert USB drive from the step 3 above into either USB-A port on front of device
4. Select Restore Setting to TV. If USB drive is not recognized or it does not contain a compatible clone file is found, this option will not be available.
5. Select the file name that you saved your configuration

**MTI/SmartPort Personality:** You can toggle between MTI and SmartPort setting here. These settings support third-party systems. Please contact your vendor for support.

**Security:** The default PIN/Password for all menus is 45066. It is possible to change the default PIN for the Television Settings by selecting Change Menu Password. Note: If the PIN is changed and forgotten, it cannot be recovered. Factory reset will be required.

**Settings:** Here you can access additional device settings by selecting Device Preferences.

**Device Preferences:** – (many of the Device Preference menus are also accessible through the TV Setup menus). It is rare that you will need to access the Device Preferences menu. The most useful options:

- About – Navigate to this menu for access to the following:
- Factory Reset – return your device to factory settings
  - Status – IP address, MAC address, up time clock
  - Product Information – model number, OS version
- Energy saver – Turn off display after 5 minutes – 24 hours.  
Restart – reboots the device

**Support Information:**  
PDi Communication Systems, Inc.  
Springboro, OH  
[www.pdiarm.com](http://www.pdiarm.com)  
800.628.9870

### Limited Warranty

PDi Communication Systems Inc., (“PDi”) standard warranty information is found at [pdiarm.com](http://pdiarm.com). For information regarding authorized servicing and all other information pertaining to this warranty, please contact PDi COMMUNICATION SYSTEMS, INC. at 40 Greenwood Ln, Springboro, Ohio 45066 or phone 800-628-9870 and ask for the PDi ProServices team.

