

PD295-002

Set Top Box
Interface Module

Document Number: PD196-244R13



 <small>Communication Systems, Inc</small> <i>Better Solutions Are Within Reach®</i>	MODEL NUMBER: PD295-002	Document Number: PD196-244R13
	Set Top Box Interface Module Instruction Manual	Page 2 of 29

Table of Contents

CAUTIONS AND WARNINGS	3
IMPORTANT SAFETY INSTRUCTIONS	4
Introduction.....	5
Compatibility.....	5
Mounting and Powering the Interface Module	6
Connections	7
Wall Mounted Televisions	7
Wall Mounted TV – Data, Power, and IR Emitter Cable Installation.....	7
Wall Mounted TV - RF Cable Installation.....	8
Arm Mounted Televisions.....	9
Arm Mounted TV – Data, Power, and IR Emitter Cable Installation	9
Arm Mounted TV - RF Cable Installation	10
TV Setup – Most PDi TVs (P14W, P16TV, P19TV, E-Series).....	13
TV Setup – A-Series	14
TV Setup – medTAB	14
Verifying and Troubleshooting Connections	14
Interface Module Setup Menus	15
Accessing Interface Module Setup Menus on most PDi TVs	15
Accessing Interface Module Setup Menus on medTAB-C.....	15
Menus 1 ~ 5	16
Menu 6	17
Programming the Interface Module.....	18
Programming the IR Code Set.....	18
Keypad Programming (Mapping) Instructions.....	19
Programming for Off-Air Non-Satellite Channels Using Off-Air RF Pass-Thru.....	19
An Example for Off-Air RF Pass-Thru.....	20
Programming the STB Signal Input Type	20
Restoring Factory Default Settings	21
Operation.....	21
Cable/Satellite TV Operation.....	21
Off-Air TV Operation (Optional).....	21
Troubleshooting	22
Appendix A - Control Device (TV) Key Reference	24
Appendix B - STB Command Reference	25
Appendix C - Factory Defaults	27
Limited Warranty	29

CAUTIONS AND WARNINGS

	This symbol indicates that dangerous voltage constituting a risk of electric shock is present within this unit.
	This symbol indicates that there are important operating and maintenance instructions in the literature accompanying this unit.

	CAUTION RISK OF ELECTRIC SHOCK, DO NOT OPEN!	
CAUTION: TO REDUCE THE RISK OF ELECTRIC SHOCK, DO NOT REMOVE COVER. NO USER SERVICEABLE PARTS INSIDE. REFER SERVICING TO QUALIFIED SERVICE PERSONNEL		



WARNING: To reduce the risk of fire or electric shock, do not expose this apparatus to rain or moisture.



WARNING: To prevent injury, this apparatus must be securely attached to the equipment rack in accordance with the installation instructions.



WARNING: Do not install this equipment in a confined space such as a bookcase or similar unit.

Modifications

Any changes or modifications made to this device that are not expressly approved by PDi may void the user's authority to operate the equipment.

Cables

Connections to this device must be made with shielded cables with metallic RFI/EMI connector hoods to maintain compliance with FCC Rules and Regulations.

Safety Instructions

To avoid any malfunctions of the unit and associated components and unwanted electric shock or fire accidents, please observe the following:

- Review the manual for your STB unit for safety instructions
- Review the manual for your PDI TV for safety instructions
- Review the manual for the rack unit.

Placement

Avoid placing the unit in surroundings with:

- High temperature (over 40 C) or high humidity (over 90%).
- Direct sunlight or heat sources, like radiators or ovens.
- Excessive dust.
- Electrostatic effect.
- Vibration, impact, or tilted surface.

Wet Areas

- Avoid rain and moisture.
- DO NOT set containers with liquid, such as vases, on top of the unit.
- Avoid placing the unit in areas where there is dripping and/or splashing.
- Avoid placing unit near standing water.

Oxygen Environment

- DO NOT use in an oxygen tent or an oxygen chamber. Such use may cause a fire hazard.

SERVICING

User Servicing

If your product is not operating correctly or exhibits a marked change in performance and you are unable to restore normal operation by following the detailed procedure in its operating instructions, do not attempt to service it yourself as opening or removing covers may expose you to dangerous voltage or other hazards. Refer all servicing to qualified service personnel.

Damage Requiring Service

Unplug this product and refer servicing to qualified service personnel under the following conditions:

- If liquid has been spilled, or objects have fallen into the product.
- If the product has been exposed to rain or water.
- If the product does not operate normally by following the operating instructions. Adjust only those controls that are covered by the operating instructions as an improper adjustment of other controls may result in damage and will often require extensive work by a qualified technician to restore the product to its normal operation.
- If the product has been dropped or damaged in any way.
- When the product exhibits a distinct change in performance which indicates a need for service.

Replacement Parts

When replacement parts are required, be sure the service technician has used replacement parts specified by the manufacturer or have the same characteristics as the original part. Unauthorized substitutions may result in fire, electric shock, or other hazards.

Safety Check

Upon completion of any service or repairs to this product, ask the service technician to perform safety checks to determine that the product is in safe operating conditions.

Cleaning & Disinfecting

- Unplug before cleaning.
- Use a soft cloth to clean.
- Do not use harsh chemicals such as solvents.

COPYRIGHT, DISCLAIMER, TRADEMARKS

Copyright

PDi Communication Systems, Inc. claims proprietary right to the material disclosed in this manual. This manual is issued in confidence for installation and operational information only and may not be used to manufacture anything shown herein. Copyright by PDi Communication System, Inc. All rights reserved.

Disclaimer

The author and publisher have used their best efforts in preparing this manual. PDi Communication Systems, Inc. makes no representation or warranties with respect to the accuracy or completeness of the contents of this manual and specifically disclaim any implied warranties of merchantability or fitness for any particular purpose and shall in no event be liable for any loss of profit or any other damages, including but not limited to special, incidental, consequential or other damages for the use of this manual. The information contained herein is believed accurate, but is not warranted, and is subject to change without notice or obligation.

Trademarks

All brand names and product names used in this manual are trademarks, registered trademarks, or trade names of their respective holders. PDi and Better Solutions Are Within Reach are registered trademarks of PDi Communication Systems, Inc.

IMPORTANT SAFETY INSTRUCTIONS

1. Read these instructions.
2. Keep these instructions.
3. Heed all warnings.
4. Follow all instructions.
5. Do not use this apparatus near water.
6. Clean only with dry cloth.
7. Do not block any ventilation openings. Install in accordance with the manufacturer's instructions.
8. Do not install near any heat sources such as radiators, heat registers, stoves, or other apparatus (including amplifiers) that produce heat.
9. Do not defeat the safety purpose of the polarized or grounding-type plug. A polarized plug has two blades with one wider than the other. A grounding type plug has two blades and a third grounding prong. The wide blade or the third prong is provided for your safety. If the provided plug does not fit into your outlet, consult an electrician for replacement of the obsolete outlet.
10. Protect the power cord from being walked on or pinched particularly at plugs, convenience receptacles, and the point where they exit from the apparatus.
11. Only use attachments/accessories specified by the manufacturer.
12. Use only with the cart, stand, tripod, bracket, or table specified by the manufacturer, or sold with the apparatus. When a cart is used, use caution when moving the cart/apparatus combination to avoid injury from tip-over.
13. Unplug this apparatus during lightning storms or when unused for long periods of time.
14. Refer all servicing to qualified service personnel. Servicing is required when the apparatus has been damaged in any way, such as power-supply cord or plug is damaged, liquid has been spilled or objects have fallen into the apparatus, the apparatus has been exposed to rain or moisture, does not operate normally, or has been dropped.

15. This appliance should be mounted in an equipment rack as recommended by the manufacturer.

16. Care should be taken so that objects do not fall and liquids are not spilled into the enclosure through openings.

17. If an outside antenna or cable system is connected to the video product, be sure the antenna or cable system is grounding so as to provide some protection against voltage surges and built-up static charges. Section 810 of the National Electrical Code, ANSI/NFPA 70, provides information with respect to proper grounding of the mast and supporting structure, grounding of the lead-in wire to an antenna discharge unit, size of grounding conductors, location of antenna-discharge unit, connection to grounding electrodes, and requirements for the grounding electrode. See Figure A.

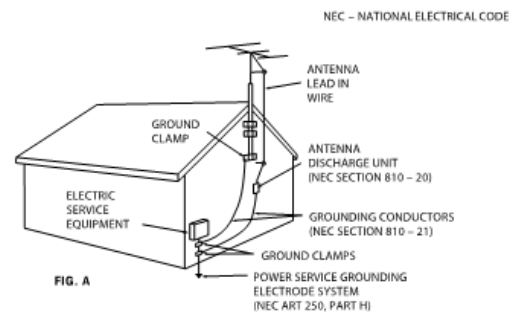

NOTE: This reminder is provided to call the CATV system installer's attention to article 820-40 of the NEC that provides guidelines for proper grounding and, in particular, specifies that the cable ground shall be connected to the grounding system of the building, as close to the point of cable entry as practical.

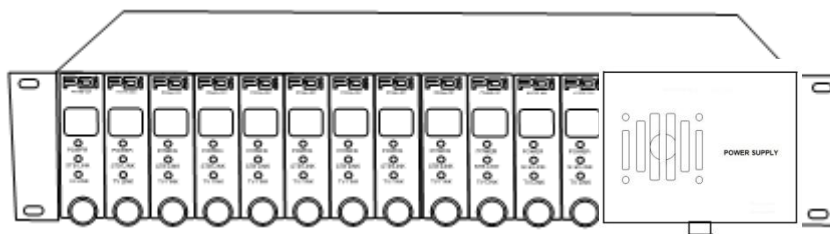

Introduction

Traditionally a facility pays for dozens or hundreds of cable/satellite channels but only has a small number of set top boxes, each locked on a single channel, and combined onto the cable plant. When a patient wants to view a channel that isn't on the cable plant, the nurse must go to the head end and change one of the receivers or tell the patient the channel is not available. To provide the full channel package to each patient, the set top box may be placed next to each TV in the patient area. Unfortunately, when the IR remote is used by one patient to change channels, any TV nearby will also change.

The PDi Interface Module is designed to improve the patient experience interacting with a TV at a facility in which the channels come from a cable/satellite set top box. It allows direct access to all set top box functions via PDi TV keypad, IR remote, Pillow speaker and PDI-Qube™ table radio. It gives patients access to every channel the facility is paying for and allows patients to easily switch between cable/satellite, in-house DVD and rooftop antenna channels. The interface module can pay for itself by eliminating modulators, splitters and combiners in most environments. It removes the need to modulate signals for distribution (by using one coax or HDMI cable from each set top box to an associated TV). It offers customizable key mapping and works in retrofit installations (in which each set top box is already modulated to a different channel and combined onto the cable plant). Best of all it's made in America!

Compatibility

The PDi interface module forms a communication bridge between a PDi TV and a set top box. Therefore, it has been designed to be compatible with as many models of TV's and set top boxes as possible. All PDi TV's larger than 10" built since 2008 are compatible. For earlier model PDi TV's look for a CCI port on the unit or contact PDi to verify.

As of this print, the following set top boxes have been tested to work with the PDi interface module. Contact PDi for compatibility with other models.

Provider	Set Top Box Model	PDi Interface Module Min Firmware Version
Cablevision	Scientific Atlanta Explorer 4250HD	V3.00
Charter/Spectrum	Motorola DCH6200	V3.03
Charter/Spectrum	Motorola DCT2224	V3.03
Comcast/Xfiniti	Pace DC50X	V2.06
Comcast/Xfiniti	Pace PXD01ANI	V3.16
Comcast/Xfiniti	Comcast PR150B	V3.00
Comcast/Xfiniti	Comcast RNG110	V3.00
COX	COX 3250HD (Scientific Atlanta Explorer 3250HD)	V3.00
Dish	Dish ViP211k	V3.00
Dish	Dish ViP222k	V3.00
Haivision	Haivision Stingray	V3.05
Haivision	Haivision Mantaray	V3.07
Time Warner Cable/Spectrum	Cisco DTA 271HD	V3.00
Time Warner Cable/Spectrum	Cisco 8742 HDC	V3.00
Time Warner Cable/Spectrum	Spectrum101-T	V3.00
Verizon		V3.03

Mounting and Powering the Interface Module

The PDi interface module is designed to slide into an industry standard mini-mod chassis and is powered by the chassis' power supply. Standard mini-mod rack mount chassis with power supply are suitable for the interface module. These include, but are not limited to:

- ATX / Pico Digital MPC-12
- Blonder Tongue MIRC-12V with MIPS-12C
- Drake® RMM-12 with PSM121
- Holland HMR with HMPS

When it is more desirable to have the set top box and interface module located near the TV, the module may be used in a stand-alone configuration without the need for a mini-mod chassis. In this case the PDi PD106-747 power adapter (not included) should be used to power the interface module. Since the interface module uses very little energy, it has no special ventilation requirements.

Connections

The PD295-002 interface module must be connected to the corresponding TV via standard CAT5 cable. The CAT5 data cable should not exceed 300 feet in length. The module must be powered via the rack mounted chassis or a standalone power adapter. The supplied IR Emitter cable must also be connected to the module and adhered to the IR window of the corresponding set top box. CAT5 and power cables are not provided with the Satellite Interface.



PD295-002 is for use with CCI Port only, Not MTI port

Wall Mounted Televisions

Wall Mounted TV – Data, Power, and IR Emitter Cable Installation

1. Connect one end of the CAT5 cable to the TV's CCI port. The CCI port is located on the back of the TV with the other connectors. Be careful not to connect to the MTI port which is usually next to the CCI port.
2. Connect the other end of the CAT5 cable to the RJ45 port on the PD295-002 interface module.
3. Connect the included IR Emitter cable to the PD295-002 interface module.
4. Remove adhesive backer from IR Emitter and secure it to the IR receiver window of the STB.
5. For chassis mounted interface module, connect chassis power cable to PD295-002. For standalone mounting, connect power cord PD106-747 to PD295-002.

Wall TV with Standalone Interface Module

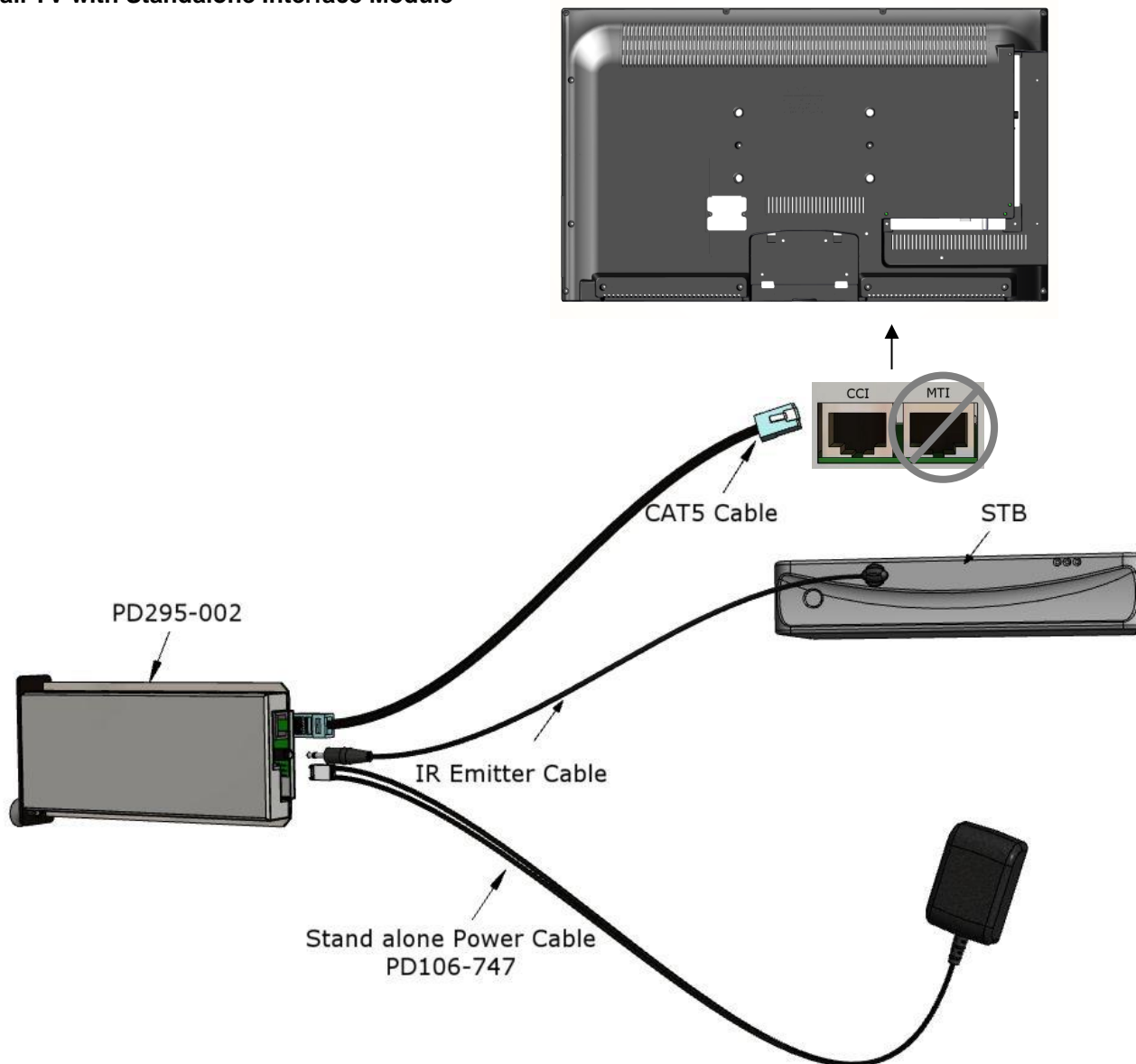

Wall TV with Chassis Mounted Interface Module

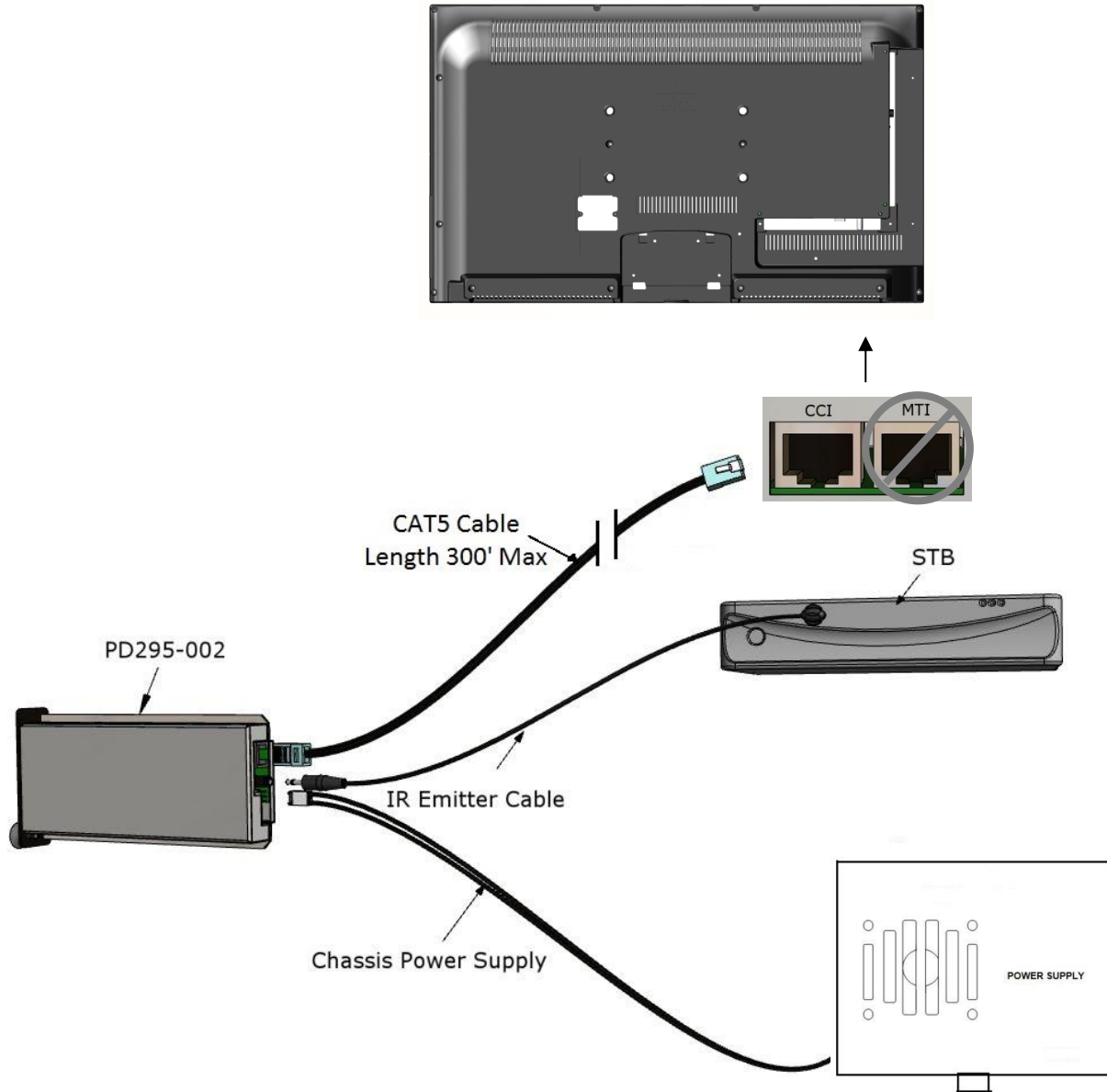

Wall Mounted TV - RF Cable Installation

The RF Output Signal cable from each set top box (STB) must also be routed to each remotely located television. Please refer to the STB installation instructions for details.



Arm Mounted Televisions

The PD295-002 interface module is also compatible with several of the PDi Arm Mounted televisions that incorporate a CCI Port. Models such as the PDI-P14 and PDI-P19TV can be used successfully with the interface module when ordered with the CCI option. The PDI-P10LCD series arm mounted TV can NOT be used with the PD295-002 interface module as it does not have a CCI Port.



NOTE: Each TV and its Support Arm must be pre-wired with a CAT5 CCI data cable. Please contact PDi Communication Systems or your PDi distributor for assistance should your TV and/or Arm lack this cable.

Arm Mounted TV – Data, Power, and IR Emitter Cable Installation

The CAT5 data cable used to connect the remotely located TV to the interface module should not exceed 300 feet in length. CAT5 and power cables are not provided with the interface module.

1. Connect one end of the CAT5 cable to the Data Cable from the Arm/TV. The in-room Data Connection is typically wall mounted as illustrated below.
2. Connect the other end of the CAT5 cable to the RJ45 port on the PD295-002 interface module.
3. Connect the IR Emitter cable to the interface module.
4. Remove adhesive backer from IR Emitter and secure it to the IR receiver window of the STB.
5. For chassis mounted interface module, connect chassis power cable to PD295-002. For standalone mounting, connect power cord PD106-747 to PD295-002.

Arm TV with Standalone Interface Module

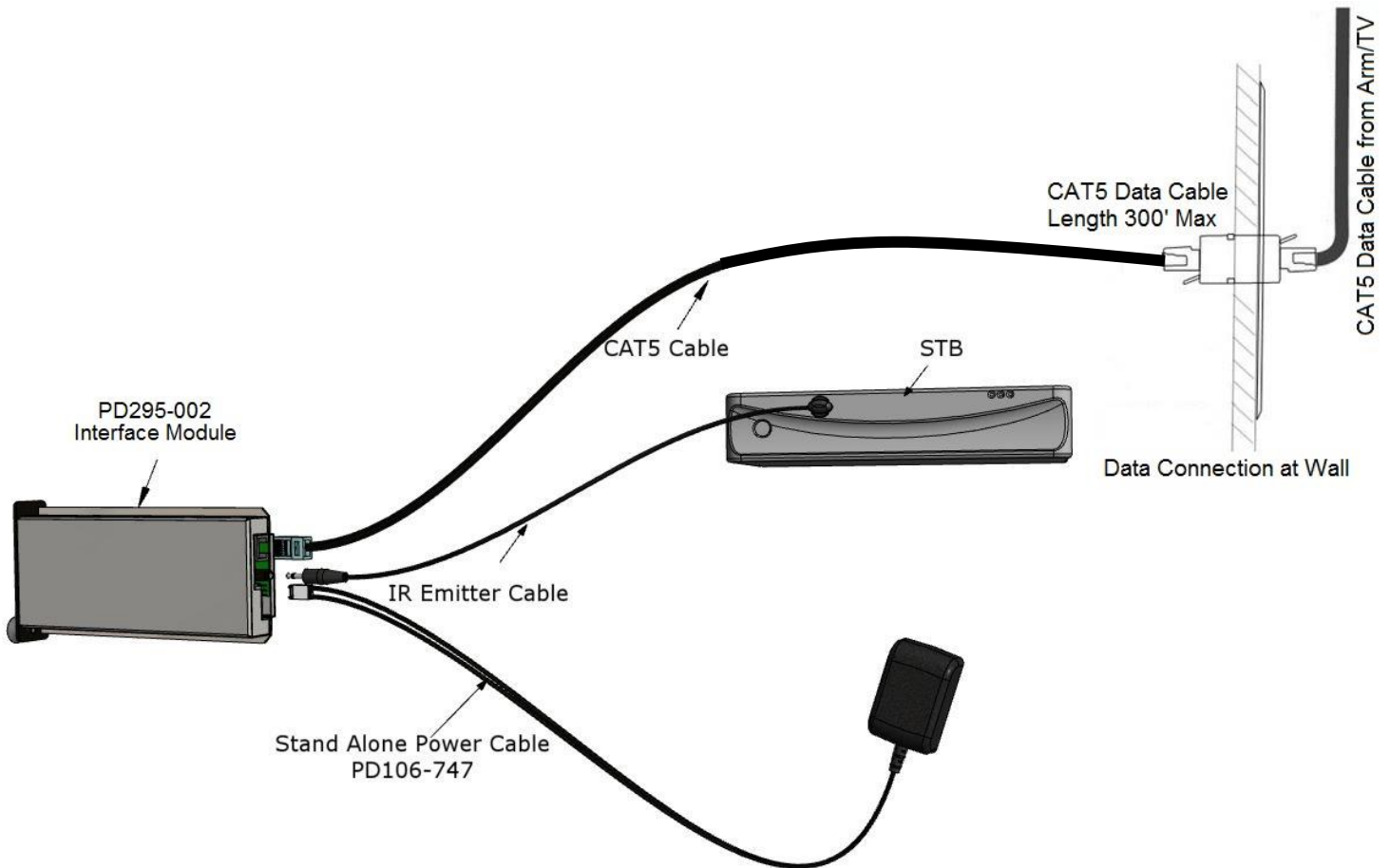

Arm TV with Chassis Mount Interface Module

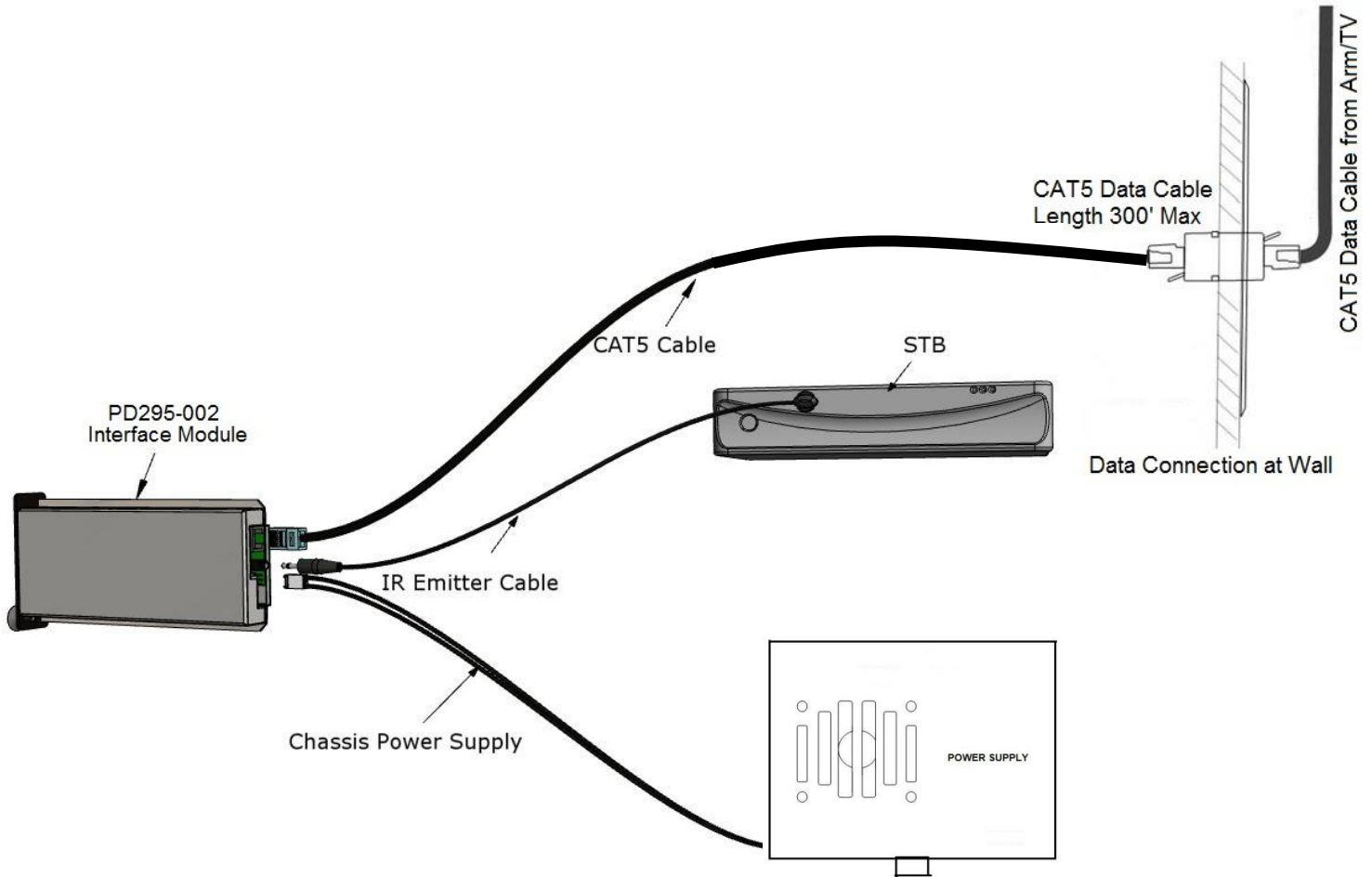

Arm Mounted TV - RF Cable Installation

Unlike AC powered wall mounted TV's, PDi arm mounted television models receive their RF signal and TV power combined together along a connecting coax cable from an external power source. Special consideration must be used in handling the low voltage AC power found on the RF signal coax cable.

Two types of external power supplies are used with arm mounted televisions: individual style and central style. The individual power supply mounts near the TV injecting power from a nearby AC outlet onto the incoming coaxial cable. The central supply injects power onto 10 separate coax cables simultaneously and mounts in a wiring closet as far as 150 feet away from the TV's. Connection of the RF signal coax cable for each style of power supply is detailed below.

Individual Style Power Supply - RF Cable Installation

Signal connections for an arm mounted TV powered from an individual power supply requires a single coax cable no longer than 300 feet, connected at the set top box's "Output to TV" connection.

Some set top boxes also allow for the connection of an external Antenna or other signal source via an "OFF-AIR IN" connection. Please consult your set top box installation instructions for details.



NOTE: The drawing below is representative of the typical set top box. Your box may vary in appearance.

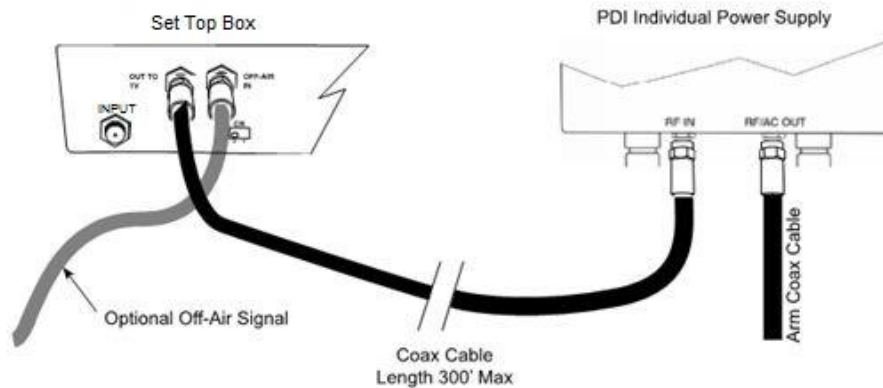

Central Style PDI -772HE Power Supply - RF Cable Installation

Low voltage AC TV power is present on each central power supply TV coax cable. A PDi Power Passer (part number PD167-003) is required to route the AC power on the coax cable around any externally connected device such as the Satellite Box. A Power Passer is required for each TV/STB connection. For new installations, the use of a PDI-772HE-IND instead of PDI-772-HE will eliminate the need for the power passers.



NOTE: The PD167-003 Power Passer is an optional device NOT supplied with the interface module and is only required for centrally powered arm mounted televisions. Please contact PDi or your PDi distributor to order this device.

1. Remove power from the TV at the central power supply.
2. Connect a coaxial cable from the STB "OUT TO TV" to the Power Passer's "RF IN FROM EXTERNAL DEVICE".
3. Locate the coaxial cable from the central power supply. Connect this cable to "FROM POWER SUPPLY".
4. Connect the coaxial cable from the TV to "COMBINED SIGNAL TO TV." The TV coax should be limited to 150' to accommodate the central power supply coax length limitations.
5. Connect an Optional Secondary RF signal coaxial cable from the Power Passer's "RF OUT TO EXTERNAL DEVICE" to the set top box "OFF-AIR IN". This connection is only necessary if you wish to view TV signals that are already present on your system in addition to set top box signals.

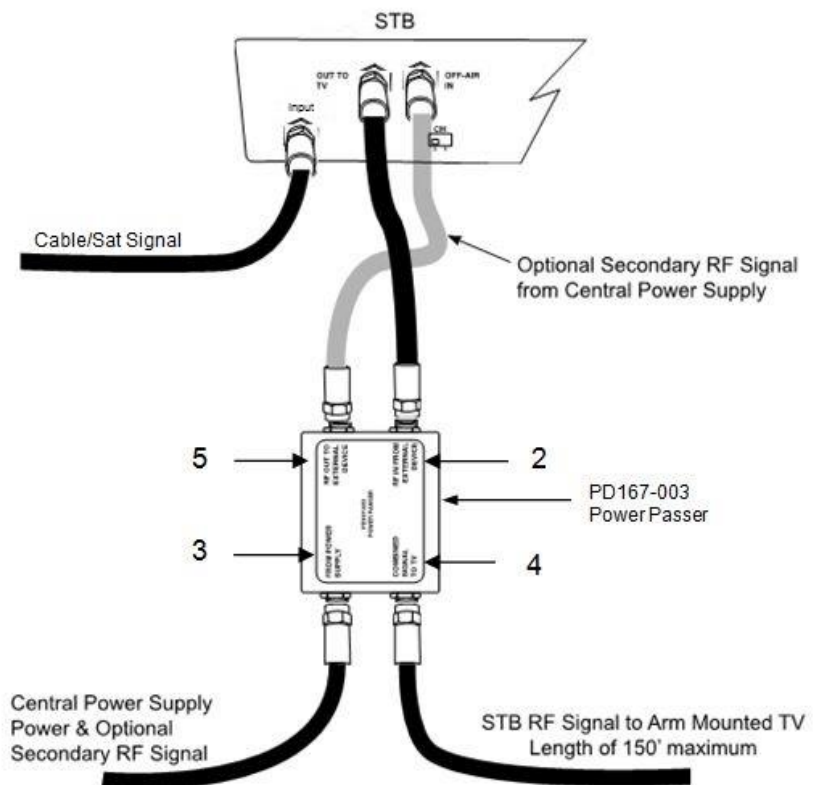

Central Style PDI-772HE-IND Power Supply - RF Cable Installation

Low voltage AC TV power is present on each central power supply TV RF out port. Each RF In port is designed to be connected to a separate RF source with minimal loss and high isolation.

1. Remove power from the TV at the central power supply.
2. Connect a coaxial cable from the set top box "OUT TO TV" to one of the 10 "RF IN" ports on the PDI-772HE-IND.
3. Connect the coaxial cable from the TV to "RF OUT". The TV coax should be limited to 150' to accommodate the central power supply coax length limitations.
4. Connect an Optional Secondary RF signal coaxial cable to the set top box "OFF-AIR IN". This connection is only necessary if you wish to view TV signals that are already present on your system in addition to set top box signals. Signal strength entering the set top box should be +3dBmV to +10dBmV.

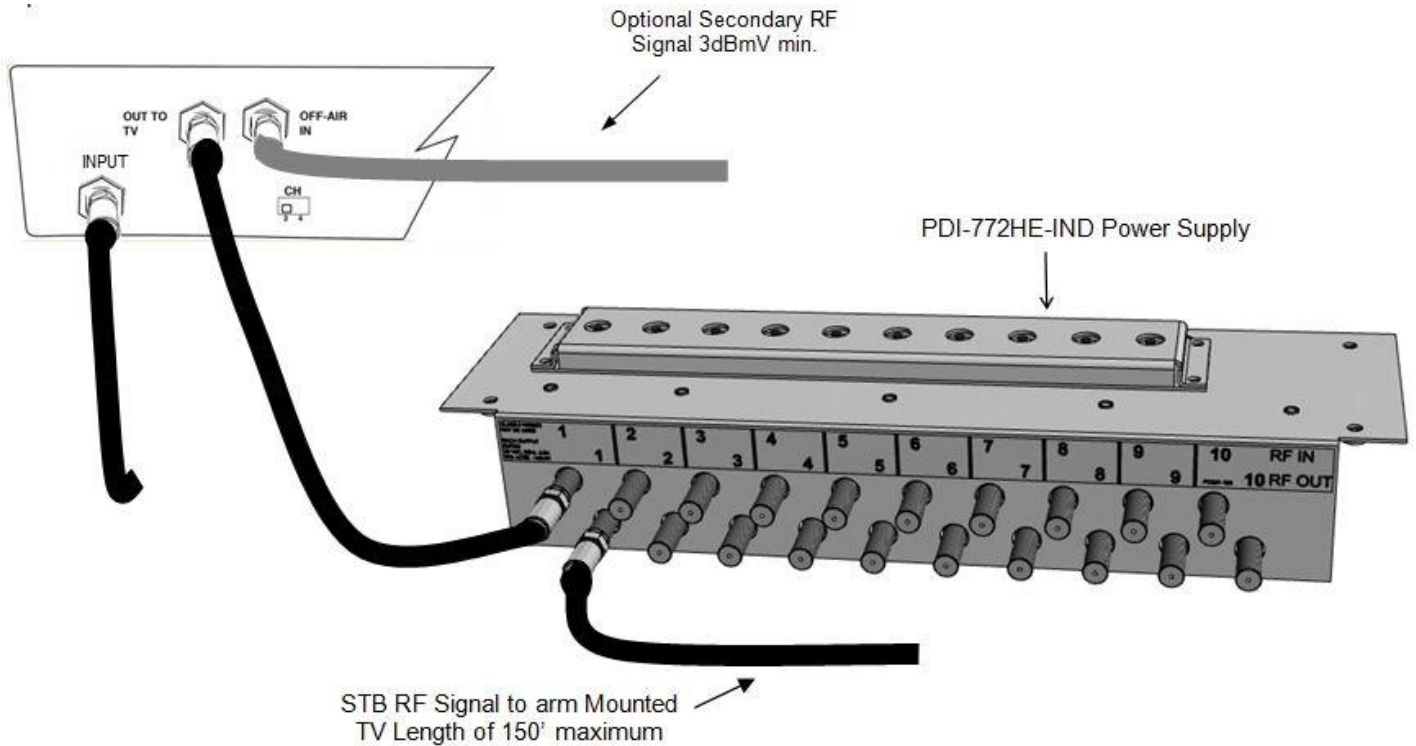

TV Setup – Most PDi TVs (P14W, P16TV, P19TV, E-Series)

To establish communication to interface module the CCI port on the TV must be active and you must have a PDi programming remote PD108-420 (not included). Follow the steps below:

1. Press SETUP to enter the TV’s setup menu.
2. From the setup menu select “Features”.
3. If the “Standby Power” setting shows in this menu, change it to “Normal”. Some TV’s do not have this setting so this step can be ignored. Other TV’s may operate the interface module on any “Standby Power” setting. This can be determined by trying it or contacting PDi.

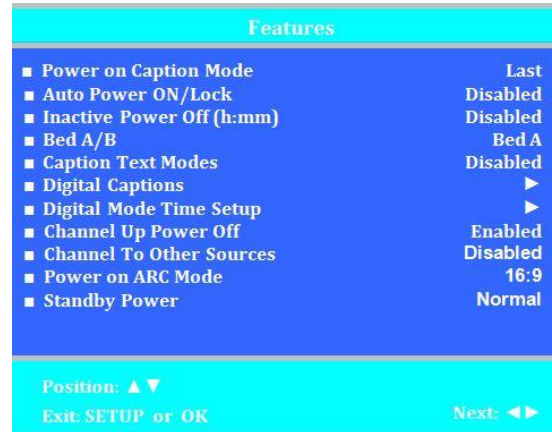

4. From the initial setup menu, select “Channels”.
5. Change the “Pro:Idiom” option to “MTI Port” or “Data Port”. Some TV’s do not have this setting. In that case, this step can be ignored.

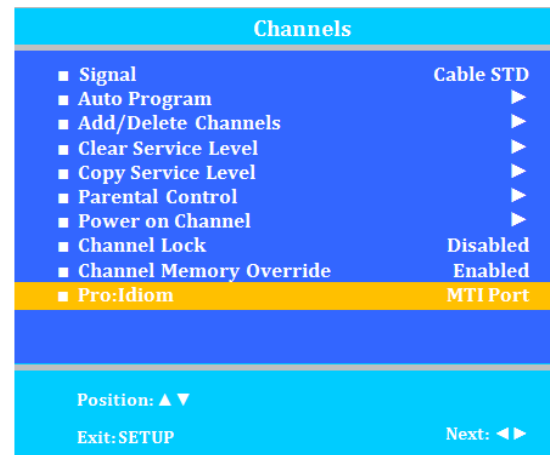

6. From the initial setup menu, select “Sources”. Set each item as detailed below.

The TV Source Setup must properly reflect the actual connections to the TV. Incorrect settings will result in loss of programming or the addition of blank signal sources. In most installations, both cable/satellite and off-air programming is delivered over RF so the “TV Tuner” must be enabled. If the cable/satellite channels are delivered over an alternate method such as HDMI, then that source must be enabled. All unused sources should be disabled.



TV Setup – A-Series

To establish communication to interface module the CCI port on the TV must be active and you must have a PDi programming remote PD108-420 (not included).

1. From the TV, open the TV Setup Menu by pressing SETUP on the programming remote.
2. Select “Sources” and then select “Source Enable”. Set each item as detailed below.

The TV Source Setup must properly reflect the actual connections to the TV. Incorrect settings will result in loss of programming or the addition of blank signal sources. In most installations, both cable/satellite and off-air programming is delivered over RF so the “TV” must be enabled. If the cable/satellite channels are delivered over an alternate method such as HDMI, then that source must be enabled. All unused sources should be disabled.

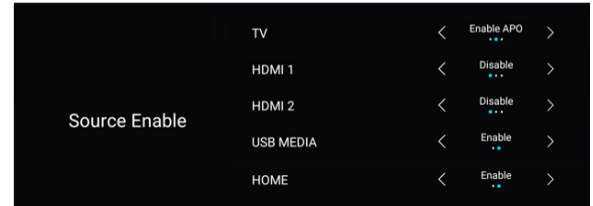

TV Setup – medTAB

medTAB14C, medTAB19C, and medTAB16C are compatible with PDi interface modules. To establish communication to interface module the CCI port on the TV must be active. Setup on the medTAB14C and medTAB16C can be completed with a PDi programming remote PD108-420 (not included). medTAB19C setup is completed through onscreen touchscreen controls.

1. From the TV app, open the TV Settings Menu, by pressing SETUP on the programming remote or by pressing Settings on the touchscreen TV controls. Enter password (“45066” is factory default).
2. Select “Advanced Option”.
3. Select “Features” then select “Input Sources”. Set each item as detailed below.

The TV Source Setup must properly reflect the actual connections to the TV. Incorrect settings will result in loss of programming or the addition of blank signal sources. In most installations, both cable/satellite and off-air programming is delivered over RF so the “TV” must be enabled. If the cable/satellite channels are delivered over an alternate method such as HDMI, then that source must be enabled. All unused sources should be disabled.

Verifying and Troubleshooting Connections

The following steps verify the data connections between the STB and TV. These instructions assume you have followed the previous connection and TV setup sections of this manual.

1. Power the TV.
2. Power the set top box.
3. Power the interface module.
4. Examine the front mounted status lights on the PD295-002 interface module. It contains a Power status light, a set top box (STB) status light and a TV status light.
 - a. Each light will turn green when properly connected.
 - b. A dark (Off) status light indicates a problem.
 - c. Blinking indicates data transfer.
 - d. All 3 lights lit indicates all connections are working properly.

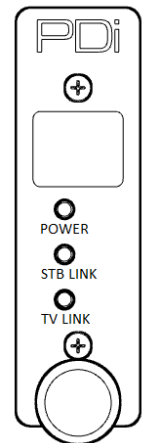

NOTE: While the link lights indicate a working connection, they do not confirm the audio/video (RF or HDMI) from the STB is connected to the correct TV. Please review the “Troubleshooting” section for additional help.

POWER	STB LINK	TV LINK	SUGGESTIONS
OFF	OFF	OFF	1. Verify interface module is powered.
ON	OFF	ON	1. Verify IR Emitter cable is properly connected to the interface module.
ON	ON	OFF	1. Verify TV is powered. 2. Verify connections to interface module, TV wall plate, and TV CCI port. 3. Make certain data cable is connected to the TV's CCI port, not MTI or Ethernet port. 4. Verify TV standby power is set to "normal" and "Pro:Idiom" is set to "MTI Port".
ON	OFF	OFF	1. Verify IR Emitter and CCI connections.
ON	ON	ON	1. All connections are proper.

Interface Module Setup Menus

The interface module is configurable from Setup menus accessed by the TV programming remote or onscreen touchscreen controls. The following instructions assume you have connected the TV, interface module, STB, and the various components according to the previous instructions contained in this manual.

Accessing Interface Module Setup Menus on most PDi TVs

1. Make certain the STB and interface module are powered. See the instructions that came with the STB for more details.



NOTE: Some set top boxes (STBs) require several minutes following application of initial power to effectively respond to commands. Please allow enough time for the STB to properly initialize.

2. Stand in front of the TV and press the SETUP button on the PD108-420 programming remote
3. When the TV Setup menu appears on the TV's screen, press SETUP a second time to display the interface module setup menu.
4. Press the "CH▲" or "CH▼" on the remote to highlight the desired option. To advance to the next page, press "CH▼" when the bottom item on the list is highlighted.
5. Press "VOL▶" or "VOL◀" on the remote to cycle through a menu item's setting options.
6. When finished, press SETUP to exit the "interface module setup" menu and save changes.

Accessing Interface Module Setup Menus on medTAB-C

1. Make certain the STB and interface module are powered. See the instructions that came with the STB for more details.



NOTE: Some set top boxes (STBs) require several minutes following application of initial power to effectively respond to commands. Please allow enough time for the STB to properly initialize.

2. From the TV app, open the TV Settings Menu, by pressing SETUP on the programming remote or by pressing Settings on the touchscreen TV controls. Enter password ("45066" is the factory default).
3. Select Advanced Option then press SETUP on the programming remote OR tap anywhere on the screen to open the STB interface module setup menu.
4. Press the "CH▲" or "CH▼" on the programming remote OR use the touchscreen navigation arrows ▲ ▼ to highlight the desired option. To advance to the next page, press "CH▼" or ▼ when the bottom item on the list is highlighted.
5. Press "VOL▶" or "VOL◀" on the programming remote OR use the touchscreen navigation arrows ▶ ◀ to cycle through a menu item's setting options.
6. When finished, press SETUP on the programming remote OR press Settings on the touchscreen controls to exit the "interface module setup" menu and save changes. **NOTE: FAILURE TO EXIT the interface module setup menu by following this step 6 could result in patient access to interface module setup menus.**

Menus 1 ~ 5

Menus 1, 2, 3, 4 and 5 provide the mapping content of a control device's keypad buttons. The factory default settings are shown in the menus pictured here in this manual. A complete listing of STB functions is provided in appendix A.

The left menu column "- TV KEY -" contains a listing of common control buttons found on pillow speakers, remotes, and television keypads.

The right menu column "- STB COMMAND-" contains default settings that work well with most STB's. Adjustment can only be made to items in the right column.



NOTE: A STB menu item that is blank does not provide any STB control functionality, and will operate the standard TV function.

INTERFACE MODULE SETUP 1/6	
-TV KEY-	-STB COMMAND-
CH Up	CH+
CH Dn	CH-
Vol Up	
Vol Dn	
Last/Prev Ch	Prev Channel
OK / Sel / Enter	Select
CC	
ARC/Ratio	Down Arrow
Mute	
Sleep	Up Arrow
SAP/MTS	
Exit: SETUP/OK	Cancel: POWER

INTERFACE MODULE SETUP 2/6	
-TV KEY-	-STB COMMAND -
0	Digit 0
1	Digit 1
2	Digit 2
3	Digit 3
4	Digit 4
5	Digit 5
6	Digit 6
7	Digit 7
8	Digit 8
9	Digit 9
Dash (-)	Info
Exit: SETUP/OK	Cancel: POWER

INTERFACE MODULE SETUP 3/6	
-TV KEY-	-STB COMMAND -
Up Arrow	Up Arrow
Dn Arrow	Down Arrow
Lt Arrow	Left Arrow
Rt Arrow	Right Arrow
Menu	Guide
Home	
Guide	Guide
Info	Info
Recall/Star (*)	Prev Channel
Exit:	Exit
Back (Nav)	Back
Exit: SETUP/OK	Cancel: POWER

INTERFACE MODULE SETUP 4/6	
-TV KEY-	-STB COMMAND -
Play	Play
Pause	Pause
Stop	Stop
Eject	Record
Rewind	Rewind
Fast Forward	FFWD
Last Track	Replay
Next Track	Advance
Exit: SETUP/OK	Cancel: POWER

INTERFACE MODULE SETUP 5/6	
-TV KEY-	-STB COMMAND -
TV/FM	Exit
TV/AV/Input	
Ch List	Guide
DVD Menu	Guide
RED	
GREEN	
YELLOW	
BLUE	
Exit: SETUP/OK	Cancel: POWER

Menu 6

Menu 6 provides STB configuration settings and firmware information.

MENU ITEM	EXPLANATION
TV Input for STB	Sets the TV's signal type input to correspond to the STB's signal output. The majority of STB's utilize modulated RF as the signal type and is the type shown in this instruction manual. TUNER is the default setting. Additional settings are available for STB's with different output signal types.
TV Chan for STB	When the STB Signal Input is set to "Tuner", this sets the channel the TV tunes to view the STB's signal. This setting should match the STB's "CH" switch setting (which is usually 3 or 4) or the modulator channel number.
STB Model	Model number of set top box. Must match actual unit for proper operation. NOTE: Changing the STB Model does not change the previous STB Key selections. If the STB Model is changed, the STB Key selections should be reviewed to determine if they are the desired mappings for the installation.
Restore Defaults for STB	Press vol▶ to restore all interface settings, for the selected STB model, to factory defaults. NOTE: Each STB model has a unique set of Factory Defaults. Selecting "Restore Factory Defaults" changes the parameters to the Factory Defaults for the selected STB model and does not change the "STB Model" selection. The default settings for each supported STB are detailed below in "Appendix B – STB Functions and Default Mapping Reference"
Flash Intface Pwr LED	This provides a diagnostic tool to help determine if the TV is connected to the expected Satellite Interface and STB. If "Flash Intface Pwr LED" is turned on, the "POWER" LED on the Satellite Interface module controlled by this TV will flash rapidly. The STB controlled by this interface will also turn on and off continuously. NOTE: This is not a stored parameter. It is automatically set to "OFF" by cycling power to the interface module.
Power Save	If "Power Save" is turned ON, the STB will be automatically powered off when the TV is turned off
Interface F/W Ver	PDi set top box Interface firmware version
TV CCI Ver	CCI communication protocol version reported by TV
IR Cable	Connection status of IR Emitter cable to the interface module.

INTERFACE MODULE SETUP 6/6	
TV Input For STB	Tuner
TV Chan For STB	003
STB Model	Cmcst X1
Restore Defaults for STB	>
Flash Intface Pwr LED	Off
Power Save	On
DIAGNOSTICS	
IR Interface F/W Ver	V3.16
TV CCI Ver	V5.2
IR Cable	Connected
Exit: SETUP/OK	Cancel: POWER

Programming the Interface Module

Programming the IR Code Set

The Interface Module sends infrared (IR) codes that mimic the set top box's remote control. Therefore the interface must know which set top box is being controlled to send the proper codes.

1. Enter the Interface Module Setup Menu (See "Understanding Interface Module Setup Menus" earlier in this manual).
2. Select menu Interface Module SETUP 6/6".
3. Set "STB Model" to match the actual model of the STB.
4. Perform a factory reset (See Restoring Factory Default Settings later in this manual).

Provider	Set Top Box Model	On Screen "STB Model" Setting
Cablevision	Scientific Atlanta Explorer 4250HD	SciAtl/Cisco
Charter/Spectrum	Motorola DCH6200	Moto/Arris
Charter/Spectrum	Motorola DCT2224	Moto/Arris
Comcast/Xfiniti	Pace DC50X	Cmcst X1
Comcast/Xfiniti	Pace PXD01ANI	Cmcst X1
Comcast/Xfiniti	Comcast PR150B	Cmcst Legacy
Comcast/Xfiniti	Comcast RNG110	Cmcst Legacy
COX	COX 3250HD (Scientific Atlanta Explorer 3250HD)	SciAtl/Cisco
Dish	Dish ViP211k	Dish
Dish	Dish ViP222k	Dish
Haivision	Haivision Stingray	Hai Stingray
Haivision	Haivision Mantaray	Hai Mantaray
Time Warner Cable/Spectrum	Cisco DTA 271HD	SciAtl/Cisco
Time Warner Cable/Spectrum	Cisco 8742 HDC	SciAtl/Cisco
Time Warner Cable/Spectrum	Spectrum101-T	SciAtl/Cisco
Verizon		Moto/Arris

Keypad Programming (Mapping) Instructions

The set top box (STB) can be controlled remotely by any of the following that incorporate a keypad: PDi-Qube™, Pillow Speaker, TV's Keypad (Arm Mounted TV's), or Handheld Remote Control. In other words, any control device that incorporates a keypad capable of controlling the TV can also control the set top box.

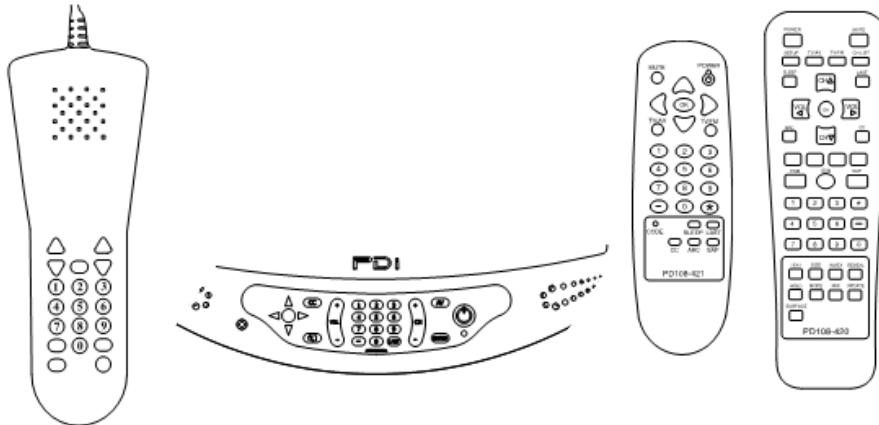

Keypad Programming or Mapping involves assigning key functions to the corresponding set top box (STB) functions. It is common practice to designate a control button to activate the STB's Channel "Guide" feature. This feature allows for quicker selection of satellite channels. Some common control buttons used for "Guide" are listed below. Your installation may vary depending upon the control device's availability of these particular buttons.

Control Button	STB Function
Menu	Guide
(-)	Guide

1. Enter the Interface Module Setup Menu (See "Understanding Interface Module Setup Menus" earlier in this manual).
2. Select menu pages 1 through 5.
3. For each "TV Key" on the left column, set the matching "STB COMMAND" on the right column to the desired STB function.

Programming for Off-Air Non-Satellite Channels Using Off-Air RF Pass-Thru

The set top box (STB) can be remotely turned off, which allows any signal connected to the "OFF-AIR" input of the STB to be active and then viewed downstream by the TV. The Off-Air signal could be a DVD player for an in-house movie channel, an externally connected antenna for local over-the-air channels, or cable TV channels. See pages 7 or 8 for details regarding connection of an Off-Air signal.



NOTE: Off-Air signals are optional and may not be available at the facility. Some set top boxes do not have off air pass through. In either case this instruction section may be skipped.

To view an Off-Air signal, the patient must turn Off the STB. A control key must be assigned to perform this function. The control key should NOT be the TV's POWER button as it is used to power the TV On and Off. Instead, another key must be selected. Below are some suggestions for STB "Power" keys that might be utilized on some common control devices.

CONTROL DEVICE	SUGGESTED CONTROL KEY
Pillow Speaker	ALT, MENU, TV/AV
TV Keypad	MENU, OK, AV
Remote	TV/AV, (-)

An Example for Off-Air RF Pass-Thru

A facility has an outside antenna that contains several local TV channels that they wish to provide to their patients for viewing in addition to Satellite TV channels.

The facility is equipped with the PDI-P15X arm mounted television powered remotely from a central style power supply. The Off-Air antenna signal is connected to the input of the central power supply and the STB is connected using the Optional Secondary RF Coax cable as shown on pages 8 and 9.

For this configuration, the yellow (Menu) button on the TV's keypad is chosen to Power the STB on and off by changing the mapping of the TV "Menu" key to "Power".

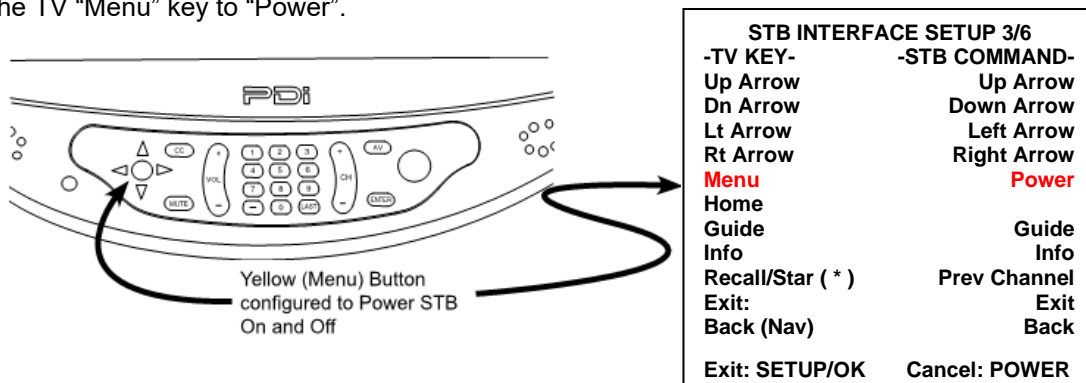

Now, Exit the Interface Module SETUP menu by pressing the SETUP button on the programming remote.

Pressing the "MENU" button on the TV's keypad should power the STB on and off with each key press. The only remaining setup involves programming the TV for the Off-Air channels while the STB is off. The TV's channel programming is not required to include the STB's channel as well. For example, if the STB is set for channel 3 output, the same channel could be omitted from the TV's channel table, if no local channel 3 is available. Please see the programming instructions specific to the model PDi TV being used.

Programming the STB Signal Input Type

The Interface Module must be programmed so that it knows which TV source input needs the keys to be mapped to the STB. When any other signal source is selected, all keys will operate normally.

1. Enter the Interface Module Setup Menu (see "Understanding Interface Module Setup Menus" earlier in this manual)
2. Select menu "Interface Module SETUP 6/6".
3. Set "STB Signal Input" to match the connection to the STB. This is usually Tuner, but may be "HDMI" or "Component" for high definition STB's.
4. If "STB Signal Input" is "Tuner" then set the "STB Channel" to match the STB's modulated RF output. The illustration depicts the channel as number 3 in this example.
5. Exit setup. Verify the STB signal is now displayed on the television.

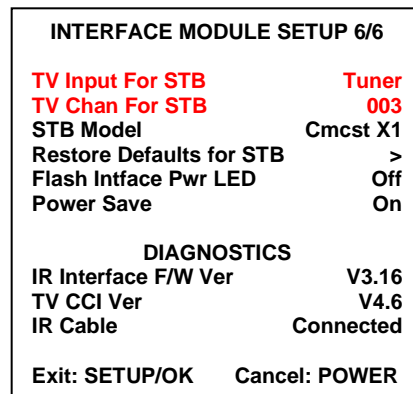
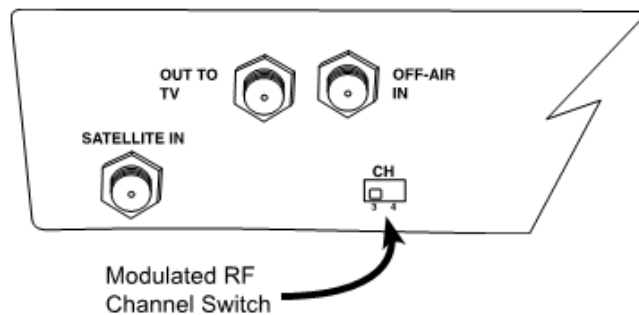

Restoring Factory Default Settings

The Interface Module configuration can be reset to factory defaults. Resetting to defaults cannot be undone. If the Interface is connected to a PDI-P19W the default configuration will be optimized for the P19W's keypad. It will not match the settings that came preloaded onto the Interface.

1. Enter the Interface Module Setup Menu (See "Understanding Interface Module Setup Menus" earlier in this manual).
2. Select menu "Interface Module SETUP 6/6".
3. Highlight the "Restore Factory Defaults" item.
4. Press "VOL▶" to restore factory defaults. The operation will happen immediately and cannot be undone.

INTERFACE MODULE SETUP 6/6	
TV Input For STB	Tuner
TV Chan For STB	003
STB Model	Cmcst X1
Restore Defaults for STB	>
Flash Interface Pwr LED	Off
Power Save	On
DIAGNOSTICS	
IR Interface F/W Ver	V3.16
TV CCI Ver	V4.6
IR Cable	Connected
Exit: SETUP/OK	Cancel: POWER

Operation

PDI Interface Module operation is straight forward once configured. Site installations that involve a secondary "Off Air" signal require additional instruction to provide a worry-free patient viewing experience.

Cable/Satellite TV Operation

1. Turn the TV on. A channel from the set top box should be displayed.
2. Channel the TV Up or Down. The set top box channel should follow.
3. Press the designated Guide button or press "00". A channel guide should appear.
4. Select a channel from the Guide. The viewed set top box channel should follow the selection.

Off-Air TV Operation (Optional)

1. a. If using the TV Tuner for cable/satellite programming, press the control button designated for STB Power (see section "Programming for Off-Air Non-Satellite Channels Using OFF-AIR RF Pass-Thru").
b. If using an input other than RF Tuner for cable/satellite programming, press the TV/AV key repeatedly until the TV Tuner source is selected.
2. The STB signal should disappear.
3. Channel the TV Up or Down. The TV should now tune the Off-Air channels (non-STB channels).
4. a. If using the TV Tuner for cable/satellite programming, press the control button designated for STB Power again.
b. If using an input other than RF Tuner for cable/satellite programming, press the TV/AV key again until the cable/satellite box source is selected.
5. The Off-Air channel should disappear and be replaced with a cable/satellite channel.
6. Press the TV's power button to turn off the TV at any time.

Troubleshooting

Symptom	Resolution
<p>The set top box is being controlled by IR interference from other remotes or IR emitters</p>	<p>Depending on the location of the set top box, the set top box may experience interference from fluorescent lights, IR remotes or from other IR emitters on set top boxes in the same area.</p> <p>The IR emitter supplied with the PD295-002 allows the pass through of other external IR signals through its outward facing side. This IR emitter also sends the IR signal out the side opposite the cable entry, besides sending the signal through the side mounted to the set top box.</p> <p>Fluorescent lights emit IR noise that reduces the sensitivity of the set top box IR receiver.</p> <p>If there is a possibility that the IR emitter can be exposed to unwanted IR signals in the area, it is recommended that the IR emitter be covered with tape that blocks IR.</p>
<p>Set top box and TV are out of sync</p> <p>Set top box is ON when the TV is OFF or set top box is OFF when the TV is ON</p>	<p>It is possible that the TV power state and the set top box power state get out of synchronization; the set top box is off when the TV is on. To correct this problem, turn both the TV OFF and set top box OFF.</p> <p>If the problem persists, the IR emitter cable may not be aimed well enough for the set top box to receive the proper signal. Try moving the IR emitter and then covering it with black tape as suggested above.</p>
<p>TV turns on but does not control the set top box. There may be only a black screen or a fixed satellite channel that cannot be changed.</p>	<p>There can be many causes including a locked up set top box, miswiring, or incorrect configuration settings.</p> <ol style="list-style-type: none"> 1. Reset the set top box using one of two ways. <ol style="list-style-type: none"> a. Push the reset button on the set top box. b. Remove power from the set top box for 30 seconds. 2. Check the wiring. The signal loop must be correct and complete. The CCI cable from the TV must connect to the Interface Module which is in turn connected by IR emitter to the STB that is sending audio/video and optionally power to the same TV. <div data-bbox="812 1239 1299 1659" style="text-align: center;"> <pre> graph TD TV[TV] --> CPS[Coax Power Supply (optional)] TV --> IM[Interface Module] CPS --> RFM[RF Modulator (optional)] RFM --> STB[Set Top Box] IM --> STB </pre> </div> <ol style="list-style-type: none"> a. Visually verify as many connection points as possible. Sometimes this is not easy, so proceed to the next step. b. Verify all 3 LEDs are lit for the Interface Module that is supposed to be connected to this TV. See “Verifying and Troubleshooting Connections”. If they are lit there is certainly a connection to a TV and set top box, but possibly not to the correct devices. c. Turn on “Flash Intface Pwr LED” to identify the Interface Module connected to this TV as well as the STB which is being controlled by this TV. See section “Interface Module

Setup Menus". Verify the correct Interface Module has a blinking POWER LED and that the expected STB is slowly turning on and off.

3. Check the Interface Module configuration.
 - a. Verify the Interface Module "STB Model" parameter is set properly. See "Programming the IR Code Set", page 18.
 - b. Verify the Interface Module "TV Input for STB" parameter is set to the source input (such as TUNER, HDMI 1, etc.) that matches the set top box's connection to the TV. See "Programming the STB Signal Input Type", page 20.
 - c. If the video input to the TV is RF/TUNER, verify the Interface Module "TV Chan for STB" parameter is set to the channel that matches the set top box's RF modulator. See "Programming the STB Signal Input Type", page 20.

Additional steps for Dish receivers:

Dish receivers must be set to Primary Remote Address #1 for proper operation.

Verify the remote address setting by pressing "System Info" on the Dish receiver's front panel. The system Information screen displays on the TV showing the Primary Remote Address. If the value is not 1, then follow these steps to reset it.

1. Turn off all other nearby Dish receivers.
2. Aim the Dish IR remote at the powered on receiver.
3. Press and hold SAT on the Dish IR remote control, for about three seconds, until all mode buttons light up. Release SAT.
4. Use the NUMBER PAD on the Dish remote to enter the number 1.
5. Press POUND(#). If the address was entered correctly, SAT will flash three times.
6. Press RECORD on the Dish remote. The TV screen should update. Make sure the Primary Remote Address shown on the System Information screen is now '1'.
7. Press SELECT to remove the System Information screen.

Appendix A - Control Device (TV) Key Reference

A listing of Control Device Keys is provided below. Each control device key can be programmed to send a supported command to a connected set top box. Please refer to sections "TV Setup" and "Understanding Interface Module Setup Menus" for programming details.

NOTE: A "Control Device Key" (also referenced as a 'TV Key') is a key located on the front panel of a PDi TV and/or on a PDi TV compatible controller (IR remote control, pillow speaker, or wireless control device).

Control Device Key
Ch Up
Ch Down
Vol Up
Vol Down
Menu
Last/Prev Ch
OK/Sel/Enter
CC
ARC/Ratio
Mute
Sleep
0
1
2
3
4
5
6
7
8
9
Play
Pause
Stop
Eject
Rewind
Fast Forward
Last Track
Next Track
Up Arrow
Down Arrow
Left Arrow
Right Arrow
Dash (-)
TV/FM
TV/AV/Input
SAP/MTS
Ch List
Guide
Info
Recall/Star (*)
Exit
Back (Nav)
Home
DVD Menu
RED
GREEN
YELLOW
BLUE

Appendix B - STB Command Reference

A listing of all STB commands for each of the compatible set top box is provided below. Refer to section "Understanding Interface Module Setup Menus" for programming details to change the "STB Model" selection and to change the "STB Command" that a "Control Device Key" controls.

NOTE: The set top box may not support all the functions shown.

Available STB Commands

Cmcst X1	Cmcst Legacy	SciAtl/ Cisco	Dish	Moto/Arris	Hai Stingray	Hai Mantaray
Digit 0	Digit 0	Digit 0	Digit 0	Digit 0	Digit 0	Digit 0
Digit 1	Digit 1	Digit 1	Digit 1	Digit 1	Digit 1	Digit 1
Digit 2	Digit 2	Digit 2	Digit 2	Digit 2	Digit 2	Digit 2
Digit 3	Digit 3	Digit 3	Digit 3	Digit 3	Digit 3	Digit 3
Digit 4	Digit 4	Digit 4	Digit 4	Digit 4	Digit 4	Digit 4
Digit 5	Digit 5	Digit 5	Digit 5	Digit 5	Digit 5	Digit 5
Digit 6	Digit 6	Digit 6	Digit 6	Digit 6	Digit 6	Digit 6
Digit 7	Digit 7	Digit 7	Digit 7	Digit 7	Digit 7	Digit 7
Digit 8	Digit 8	Digit 8	Digit 8	Digit 8	Digit 8	Digit 8
Digit 9	Digit 9	Digit 9	Digit 9	Digit 9	Digit 9	Digit 9
Power	Power	Power	Power	Power	Power	Power
Info	Info	Info	Info	Info	Info	Info
CH+	CH+	CH Up	CH Up	CH Up	CH+	CH+
CH-	CH-	CH Down	CH Down	CH Down	CH-	CH-
OK /Select	OK /Select	Select	Select	Select	OK	OK
Last	Last	Last	Recall	Last	Enter/FIback	Prev Chan
FAV	FAV	FAV	(*)	FAV	Help	CC
Right Arrow	Right Arrow	Right Arrow	Right Arrow	Right Arrow	Right Arrow	Right Arrow
Left Arrow	Left Arrow	Left Arrow	Left Arrow	Left Arrow	Left Arrow	Left Arrow
Up Arrow	Up Arrow	Up Arrow	Up Arrow	Up Arrow	Up Arrow	Up Arrow
Down Arrow	Down Arrow	Down Arrow	Down Arrow	Down Arrow	Down Arrow	Down Arrow
HD Zoom	HD Zoom	ENTER	(#)	(#)	Sleep	Mute
Exit	Exit	EXIT	Cancel	EXIT	Cancel/Clear	Clear
Guide	Guide	Guide	Guide	Guide	Guide	Guide
Menu	Menu	Menu	Menu	Menu	Menu	Settings
Search	Search	DVR LIST	Search	LIST	Search	VOD
Red (C)	Red (C)	Red (C)	Red	Red (C)	Red/Mute	Red
Help	Help	Green (D)	Green	Green (D)	Green/CC	Green
Yellow (A)	Yellow (A)	Yellow (A)	Yellow	Yellow (A)	Yellow	Yellow
Blue (B)	Blue (B)	Blue (B)	Blue	Blue (B)	Blue	Blue
Pause	Pause	Pause	Pause	Pause	Pause	Pause
Rewind	Rewind	Rewind	Back	Rewind	Rewind	Rewind
Play	Play	Play	Play	Play	Play	Keyboard
Stop	Stop	Stop	Stop	Stop	Jump Back	Stop
REC	REC	REC	Record	REC	Jump to End	Audio
Replay	Replay	Replay	Skip Back	Replay	Skip Back	Skip Back
Fast Forward	Fast Forward	Fast Forward	Fast Forward	Fast Forward	Fast Forward	Fast Forward
ON DEMAND	ON DEMAND	ON DEMAND	ON DEMAND	ON DEMAND	Skip Fwd	Skip Fwd

Available STB Commands (continued)

Cmcst X1	Cmcst Legacy	SciAtl/ Cisco	Dish	Moto/Arris	Hai Stingray	Hai Mantaray
Page Up	Page Up	PAGE +	Page Up	PAGE +	VOL+	VOL+
Page Down	Page Down	PAGE -	Page Down	PAGE -	VOL-	VOL-
PIP (On-Off)	PIP (On-Off)	PIP (ON OFF)	PIP	PIP (ON OFF)	PIP	Video
PIP (Swap)	PIP (Swap)	PIP (SWAP)	PIP Swap	PIP (SWAP)	PIP Swap	Unmarked 1
PIP (Move)	PIP (Move)	PIP (MOVE)	Position	PIP (MOVE)	Hide	Unmarked 2
PIP (CH +)	PIP (CH +)	PIP (CH +)	Skip FWD	PIP (CH +)	Bookmark	Hotmark
PIP (CH -)	PIP (CH -)	PIP (CH -)	dish	PIP (CH -)	V1 (Favorite)	Unmarked 3
LIVE	LIVE	LIVE	LIVE	LIVE	V2 (Favorite)	
TV/ VCR/ Input	TV/ VCR/ Input	INPUT	INPUT	VIDEO SOURCE	V3 (Favorite)	
Language (D)	Language (D)	HD ZOOM		(*)		
My DVR	My DVR	SETTINGS		SETTINGS		
		CC		DAY +		
		USER		DAY -		

Appendix C - Factory Defaults

Control Device Key	Default STB Command						
	Cmcst X1	Cmcst Legacy	SciAtl/ Cisco	Dish	Moto/Arris	Hai Stingray	Hai Mantaray
Ch Up	CH+	CH+	CH Up	CH Up	CH Up	CH+	CH+
Ch Dn	CH-	CH-	CH Down	CH Down	CH Down	CH-	CH-
Vol Up							
Vol Down							
Menu	Guide	Guide	Guide	Guide	Guide	Guide	Guide
Last/Prev Ch	Last	Last	Last	Recall	Last	Enter/ Fback	Prev Chan
OK/Select/ Enter	OK/Select	OK/Select	Select	Select	Select	OK	OK
CC						Green/CC	CC
ARC/Ratio	Down Arrow	Down Arrow	Down Arrow	Down Arrow	Down Arrow	Down Arrow	Down Arrow
Mute							
Sleep	Up Arrow	Up Arrow	Up Arrow	Up Arrow	Up Arrow	Sleep	Up Arrow
0	Digit 0	Digit 0	Digit 0	Digit 0	Digit 0	Digit 0	Digit 0
1	Digit 1	Digit 1	Digit 1	Digit 1	Digit 1	Digit 1	Digit 1
2	Digit 2	Digit 2	Digit 2	Digit 2	Digit 2	Digit 2	Digit 2
3	Digit 3	Digit 3	Digit 3	Digit 3	Digit 3	Digit 3	Digit 3
4	Digit 4	Digit 4	Digit 4	Digit 4	Digit 4	Digit 4	Digit 4
5	Digit 5	Digit 5	Digit 5	Digit 5	Digit 5	Digit 5	Digit 5
6	Digit 6	Digit 6	Digit 6	Digit 6	Digit 6	Digit 6	Digit 6
7	Digit 7	Digit 7	Digit 7	Digit 7	Digit 7	Digit 7	Digit 7
8	Digit 8	Digit 8	Digit 8	Digit 8	Digit 8	Digit 8	Digit 8
9	Digit 9	Digit 9	Digit 9	Digit 9	Digit 9	Digit 9	Digit 9
Play	Play	Play	Play	Play	Play	Play	Play
Pause	Pause	Pause	Pause	Pause	Pause	Pause	Pause
Stop	Stop	Stop	Stop	Stop	Stop		Stop
Eject	REC	REC	REC	Record	REC		
Rewind	Rewind	Rewind	Rewind	Back	Rewind	Rewind	Rewind
Fast Forward	Fast Forward	Fast Forward	Fast Forward	Fast Forward	Fast Forward	Fast Forward	Fast Forward
Last Track	Replay	Replay	Replay	Skip Back	Replay	Skip Back	Skip Back
Next Track			ON DEMAND	ON DEMAND	ON DEMAND	Skip Fwd	Skip Fwd
Up Arrow	Up Arrow	Up Arrow	Up Arrow	Up Arrow	Up Arrow	Up Arrow	Up Arrow
Down Arrow	Down Arrow	Down Arrow	Down Arrow	Down Arrow	Down Arrow	Down Arrow	Down Arrow
Left Arrow	Left Arrow	Left Arrow	Left Arrow	Left Arrow	Left Arrow	Left Arrow	Left Arrow
Right Arrow	Right Arrow	Right Arrow	Right Arrow	Right Arrow	Right Arrow	Right Arrow	Right Arrow
Dash (-)							Info
TV/FM	Exit	Exit	Exit	Cancel	Exit	Cancel/ Clear	Clear
TV/AV/Input							
SAP/MTS	Language (D)	Language (D)					Audio
Ch List	Guide	Guide	Guide	Guide	Guide	Guide	Guide
Guide	Guide	Guide	Guide	Guide	Guide	Guide	Guide
Info	Info	Info	Info	Info	Info	Info	Info
Recall/Star (*)	Last	Last	Last	Recall	Last	Enter/ Fback	Prev Chan
Exit	Exit	Exit	Exit	Cancel	Exit	Cancel/ Clear	Cancel/ Clear
Back (Nav)						Jump Back	Prev Chan



Factory Defaults (continued)

Default STB Command							
Control Device Key	Cmcst X1	Cmcst Legacy	SciAtl/ Cisco	Dish	Moto/Arris	Hai Stingray	Hai Mantaray
Home							
DVD Menu	Menu	Menu	Guide	Guide	Guide	Menu	Settings
RED	Red (C)	Red (C)	Red (C)	Red	Red (C)	Red/Mute	Red
GREEN	Help	Help	Green (D)	Green	Green (D)	Green/CC	Green
YELLOW	Yellow (A)	Yellow (A)	Yellow (A)	Yellow	Yellow (A)	Yellow	Yellow
BLUE	Blue (B)	Blue (B)	Blue (B)	Blue	Blue (B)	Blue	Blue

Default Setting							
Parameter	Cmcst X1	Cmcst Legacy	SciAtl/ Cisco	Dish	Moto/Arris	Hai Stingray	Hai Mantaray
TV Input for STB	Tuner	Tuner	Tuner	Tuner	Tuner	Tuner	Tuner
TV Chan for STB	003	003	003	003	003	003	003
Power Save	On	On	On	On	On	On	On

Limited Warranty

PDi Communication Systems Inc., ("PDi") warrants, to the original purchaser only, that the product will be free from defects in materials and workmanship, under normal use, for 2 years from the date of original purchase. This warranty does not cover any other equipment that may have been included with PDi's shipment of this product.

After receipt of written notice of a defect or malfunction occurring during the warranty period, PDi will repair or replace goods returned to its Springboro, Ohio location, at its discretion, the whole or any component part of any product manufactured by PDi and found by PDi to be defective. If the decision is made to replace the product, PDi will exchange the model for the same model or a model similar in form and function.

As a condition to obtaining warranty service, written notification of the defective product must be received by PDi within ten (10) days of noticing the defect. Repair of said product requires it to be shipped to the PDi factory in Springboro, Ohio. All shipments shall be F.O.B. Springboro, Ohio, and all shipping and freight charges to PDi's factory shall be paid by the customer.

For information regarding authorized servicing and all other information pertaining to this warranty, please contact PDi COMMUNICATION SYSTEMS at 40 Greenwood Lane, Springboro, Ohio 45066 or phone 800-628-9870 and ask for Service.

This warranty gives specific legal rights and you may also have other rights which vary from state to state.

Exclusions from Warranty

- Products damaged by any catastrophe, accident, or from neglect, misuse, fault, improper assembly, improper maintenance, inadequate return packaging, or negligence by the customer or any third party. They will be treated as out of warranty for external cause to the Products, such as, but not limited to, failure of or faulty electric power, air conditioning, operator error, failure or malfunction of any data communications system. Such conditions will be determined by PDi at its sole unfettered discretion.
- Service and repair of accessories, apparatus, attachments or any other devices which are not PDi products or options.
- Defacing of product, revision control and PDi labeling (label alterations, serial number missing, serial number no longer discernible and serial number invalid). All serial numbers are recorded and tracked for warranty purposes.
- Unauthorized changes, modifications or alterations in or to the Products not installed by PDi.
- Damage to or loss of any programs, data, or removable storage media.
- Damage incurred during installation, relocation or removal of the Products or any accessories, apparatus, attachments or other devices.
- Normal wear.
- The furnishing of accessories or supplies.
- Damage by shipping carrier.
- Incompatibility issues.
- Damages of any kind including, but not limited to, direct or indirect damages, lost profits, lost saving, or other special incidental, exemplary or consequential damages whether for breach of contract, tort or otherwise, or whether arising out of the use of or inability to use the product, even if PDi or any distributor, dealer, or authorized service provider has been advised of the possibility of such damages, or any claim by any other party
- Damage caused by any software or application not installed at the factory.

PDi's liability under this warranty is limited to repair or replacement of defective products and parts as provided above. PDi shall not be liable for incidental or consequential damages.*

The warranty contained herein is in lieu of all other expressed or implied warranties, including any implied warranty of merchantability or fitness for any particular purpose. PDi neither assumes nor authorizes any person to assume, on its behalf, any other obligation or liability.

*Some states do not allow the exclusion or limitation of incidental or consequential damages or a disclaimer of warranties implied by law, so the above limitation or exclusion may not apply.

The information and technical data in this manual is believed accurate, but is not warranted and is subject to change without notice or obligation. PDi reserves the right to change this policy without advance notice.