

PDI-P22LCDC

Users Manual



Model: PDI-P22LCDC
22" Hospital Grade HD LCD Television

PDi Communication Systems, Inc.
40 Greenwood Lane
Springboro, OH 45066
Office: 800.628.9870
Fax: 937.743.9871
www.pdiarm.com

Better Solutions Are
Within Reach[®]

Blank Page

WARNING



CAUTION : To reduce the risk of electric shock do not remove cover (or back). No user serviceable parts inside. Refer servicing to qualified service personnel.



This symbol is intended to alert the user of the presence of uninsulated 'dangerous voltage' within the product's enclosure that may be of sufficient magnitude to constitute a risk of electric shock to persons.



This symbol is intended to alert the user of the presence of important operating and maintenance (servicing) instructions in the literature accompanying the appliance.

NOTE TO CABLE TV INSTALLER

This reminder is provided to call the cable TV systems installer's attention to Article 820-40 of the National Electrical Code. The code provides guidelines for proper grounding and, in particular, specifies that the cable ground shall be connected to the grounding system of the building, as close to the point of the cable entry as practical.

MAINTENANCE AND SERVICING

Never remove the back cover of the TV; this can expose you to high voltage and other hazards. If the TV does not operate properly, unplug it and call an authorized service center or PDI .

CLEANING AND DISINFECTION

Clean the exterior of this television by removing dust with a lint-free cloth.

CAUTION: To avoid damage to the surface of the television, do not use abrasive or chemical cleaning agents.



RAIN AND MOISTURE

WARNING: To avoid the hazards of fire or electrical shock, DO NOT expose this television to rain or moisture.



OXYGEN ENVIRONMENT

WARNING: Do not use in any oxygen tent or oxygen chamber. Such use may cause a fire hazard.



WET LOCATION

Apparatus shall not be exposed to dripping or splashing and no objects filled with liquids, such as vases, shall be placed on the apparatus.



OVERHEAD FALLING HAZARD

WARNING: To prevent injury, this apparatus must be securely attached to the wall in accordance with the installation instructions. TVs can pose a striking hazard when mounted at an elevated position. **Use only PDI mounting brackets and appropriate hardware to assure TV will not fall from the mounted position. Failure to do so may cause injury or death.**

Warning

DISCONNECTING DEVICE FROM MAINS

Main plug is the disconnecting device. The plug must remain readily operable.

SERVICE INSTRUCTIONS

CAUTION: These servicing instructions are for use by qualified service personnel only.

To reduce the risk of electric shock, do not perform any servicing other than contained in the operating instructions unless you are qualified to do so.

PRODUCT MODIFICATION

Do not attempt to modify this product in any way without written authorization. Unauthorized modification could void the user's authority to operate this product.

REGULATORY INFORMATION: FCC

This equipment has been tested and found to comply with the limits for a Class B digital device, pursuant to part 15 of the FCC Rules. These limits are designed to provide reasonable protection against harmful interference when the equipment is operated in a residential or commercial installation. If this equipment does cause harmful interference to radio or television reception, which can be determined by turning the equipment off and on, the user is encouraged to try to correct the interference by one of more of the following measures:

- Reorient or relocate the receiving antenna.
- Increase the separation between the equipment and receiver.
- Connect the equipment into an outlet on a circuit different from that to which the receiver is connected.
- Consult the dealer or an experienced radio/TV technician for help.

Underwriters Laboratories

The model PDI-P22LCDC Hospital Grade LCD TV is a specialized LCD television. This TV is intended for entertainment and educational purposes for use in a hospital, a nursing home, a medical-care center, or a similar health care facility. The antenna or cable system connected to an apparatus is to be grounded in accordance with the National Electrical Code, ANSI/NFPA 70.



This device is safety tested and listed by the Underwriters Laboratories as a product suitable for use in health care facilities in both the United States and Canada.

Important Safety Instructions

Important safeguards for you and your new product

1. Read these instructions.
2. Keep these instructions.
3. Heed all warnings.
4. Follow all instructions.
5. Do not use this apparatus near water.
6. Clean only with dry cloth.
7. Do not block any ventilation openings. Install in accordance with the manufacturer's instructions.
8. Do not install near any heat source such as radiators, heat registers, stove, or other apparatus (including amplifiers) that produces heat.
9. Do not defeat the safety purpose of the polarized or grounding-type plug. A polarized plug has two blades with one wider than the other. A grounding type plug has two blades and a third grounding prong. The wide blade or the third prong are provided for your safety. If the provided plug does not fit into your outlet, consult an electrician for replacement of the obsolete outlet.
10. Protect the power cord from being walked on or pinched particularly at plugs, convenience receptacles, and the point where they exit from the
11. Only use attachments/accessories specified by the manufacturer.
12. Use only with the cart, stand, tripod, bracket or table specified by the manufacturer, or sold with the apparatus. When a cart is used, use caution when moving the cart / apparatus combination to avoid injury from tip-over.
13. Unplug this apparatus during lightning storms or when unused for long period of time.
14. Refer all servicing to qualified service personnel. Servicing is required when the apparatus has been damaged in any way, such as power-supply cord or plug is damaged, liquid has been spilled or objects have fallen into the apparatus, the apparatus has been exposed to rain or moisture, does not operate normally, or has been dropped.
15. Use only PDI mounts and appropriate hardware. Failure to do so could cause the set to fall and subsequent injury or death.



Copyright, Disclaimer, & Trademarks

COPYRIGHT

PDI Communication Systems, Inc. claims proprietary right to the material disclosed in this user manual. This manual is issued for user information only and may not be used to manufacture anything shown herein. Copyright 2008 by PDI Communication Systems, Inc. All rights reserved.

DISCLAIMER

The author and publisher have used their best efforts in preparing this manual. PDI Communication Systems, Inc. make no representation or warranties with respect to the accuracy or completeness of the contents of this manual and specifically disclaim any implied warranties or merchantability or fitness for any particular purpose and shall in no event be liable for any loss of profit or any other damages. The information contained herein is believed accurate, but is not warranted, and is subject to change without notice or obligation.

TRADEMARKS

Manufactured under license from Dolby Laboratories. Dolby and the double-D symbol are trademarks of Dolby Laboratories.

All other brand names and product names used in this manual are trademarks, registered trademarks, or trade names of their respective holder. PDI and Better Solutions Are Within Reach are registered trademarks of PDI Communication Systems, Inc., Springboro, Ohio.

Contents

WARNINGS	
Note to Cable TV Installers.....	3
Maintenance and Service.....	3
Cleaning and Disinfection.....	3
Service Instructions.....	4
Product Modification.....	4
REGULATORY INFORMATION	
FCC.....	4
Underwriters Laboratories.....	4
Important Safety Instructions.....	5
Copyright.....	5
Disclaimer.....	5
Trademarks.....	5
Supplied Accessories.....	8
Optional Accessories.....	8
Battery Installation.....	8
CONTROLS	
Front Panel.....	9
Rear Panel.....	10
Remote Control.....	11-12
INSTALLATION	
Location Guidelines.....	13
OSHPD (State of California Only).....	13
Cable System Grounding.....	13
Wall Mounting on Wall Bracket.....	14-15
Across-Room Wiring.....	16
CONNECTIONS	
Antenna "ANT" Connection.....	17
A/V IN.....	17
A/V OUT.....	18
S-Video Connection.....	18
Component 1 / Component 2 IN.....	19
SPDIF.....	20
Pillow Speaker.....	21
PC Connection.....	22
BASIC OPERATION	
Turning the TV On and Off.....	23
Channel Selection.....	23
Volume Adjustment.....	23
Last Channel.....	23
Sound Mute Function.....	23
Sleep Timer.....	23
On Screen Menu Language Selection.....	24
Changing the Source Input.....	24
Service Level.....	26
PICTURE	
Color Temperature.....	27
PC Analog Picture.....	27
Temperature.....	27
Clock.....	27
Phase.....	27
PC ANALOG PICTURE.	
Temperature.....	27
Clock.....	27
Phase.....	27
ARC (Aspect Ratio Control).....	27
H-Position (Horizontal Position).....	27
V-Position (Vertical Position).....	27
COMPONENT INPUT PICTURE	
Temperature.....	28
ARC (Aspect Ratio Control).....	28
H-Position (Horizontal Position).....	28
V-Position (Vertical Position).....	28

Contents

SOUND CONTROL	
Equalizer.....	29
Sound Status Memory.....	30
Balance.....	30
AVL.....	30
Surround.....	30
Minimum Volume.....	31
Maximum Volume.....	31
Power On Volume.....	31
Internal Speaker Enable.....	32
Composite / S-Video Sound Mode.....	32
CHANNEL SETUP	
Signal.....	33
Auto Program.....	34
Add / Delete Channels.....	35
Clear Service Level.....	37
Copy Service Level.....	38
Parental Control.....	39
PARENTAL CONTROL	
TV Rating.....	40
MPAA Rating.....	41
Change Password.....	42
Aux. Block Source.....	42
Block Hour.....	42
Parental Lock.....	42
Motion Picture Association of USA (MPAA) Rating Chart.....	43
TV Parental Guideline Rating System.....	43
SOURCE SETUP	
Enabling / Disabling Sources.....	44
Power On Source.....	44
FEATURES	
Power On Captions Mode.....	45
Auto Power On.....	45
Power Management.....	46
Bed A/B.....	46
Caption Text Modes.....	46
Digital Mode Time Setup.....	47
Diagnostics.....	47
Channel Up Power Off.....	48
Channel to Other Sources.....	48
FM RADIO	
FM Radio Setup.....	49
Auto Program.....	49
Add / Delete Stations.....	49
SPECIFICATIONS.....	50
TROUBLESHOOTING.....	51
LIMITED WARRANTY.....	52

Controls

Front Panel

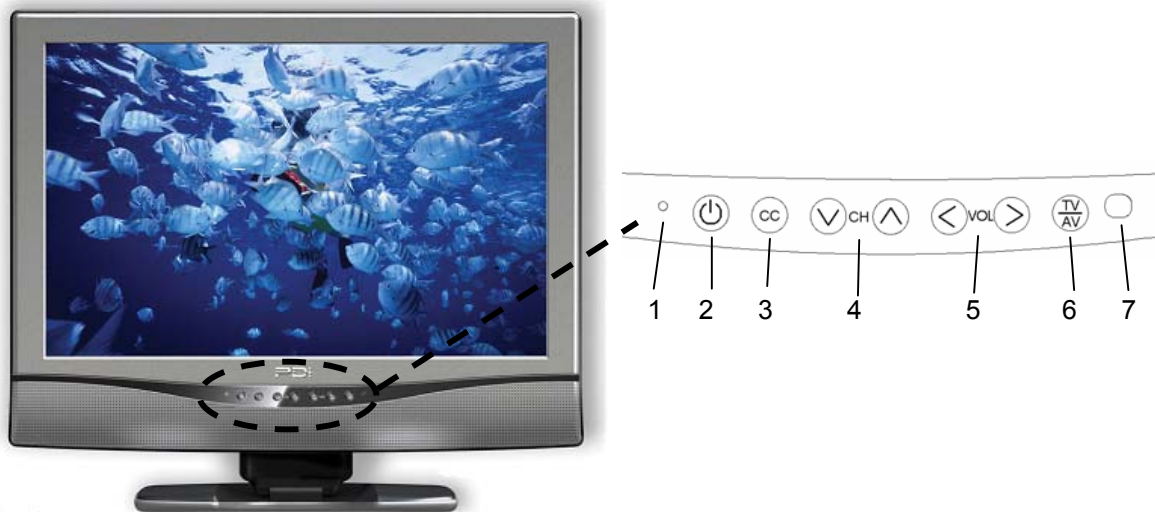

- 1 Power Indicator**
Illuminates in red when the TV is off.
Illuminates in green when the TV is switched on.
- 2 Power ON/OFF**
Switches TV set on or off.
- 3 CC**
Sets the caption function.
- 4 ▼ CH ▲ (Channel Down/Up)**
Selects a program or a menu item.
- 5 ◀ VOL ▶ (Volume Down/Up)**
Adjusts the volume. Adjusts menu settings.
- 6 TV/AV**
Selects the video mode.
- 7 Remote Control Sensor**
Accepts the IR signal of remote controller.

Control

! CAUTION !

Moving this switch changes the voltage supplied to the pillow speaker.

Make sure it is set correctly *BEFORE* plugging in the pillow speaker jumper cable.

Failure to do so WILL RESULT IN THE PILLOW SPEAKER BEING OVERDRIVEN AND POSSIBLE DAMAGE TO THE PILLOW SPEAKER.

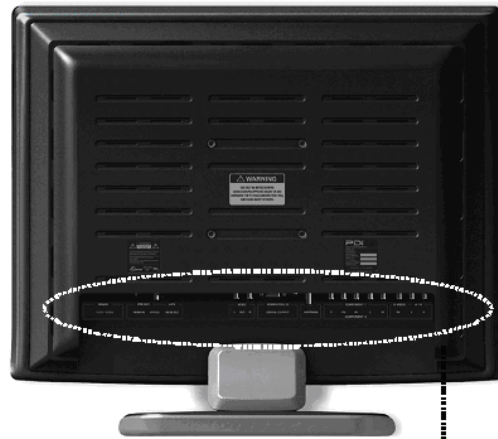

Rear Panel

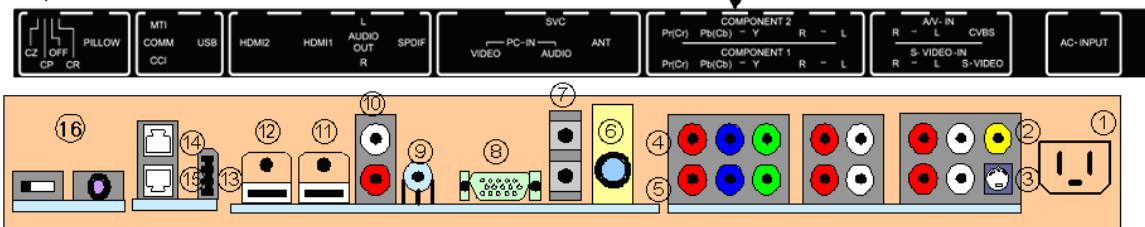

1 AC INPUT

AC power cord connection.

2 AV IN

Connect these outputs to the Audio/Video inputs of external equipment.

3 S-VIDEO IN

Connect the output of an S-VIDEO VCR to the S-VIDEO input.

4 COMPONENT2 IN

Connect the COMPONENT2 audio/video output sockets of the DVD to the COMPONENT audio/video input sockets of the set.

5 COMPONENT1 IN

Connect the COMPONENT1 audio/video output sockets of the DVD to the COMPONENT audio/video input sockets of the set.

6 ANT

Connection to Cable TV Coax.

7 SVC

Service port.

8 PC ANALOG IN (D-SUB)

Connection to the video output jack on your PC.

9 SPDIF

Provides a digital audio output signal for connection to an external digital audio device.

10 AUDIO OUT

Connection for external audio amplifier or speakers.

11 HDMI1 IN

Connection for HDMI device.

12 HDMI2 IN

Connection for HDMI device.

13 USB PORT

Firmware upgrading purpose.

14 MTI

15 CCI

16 PILLOW

Pillow speaker port.

Use the switch to select correct voltage.

CZ : Zenith Compatible (+14V)

CP : Philips Compatible (+5V)

CR : RCA Compatible (-5V)

Off : Pillow port disable (0V)

Programming Remote Control

A programming remote control is required to perform all TV setup adjustments including programming channels. The remote is **NOT** included with the TV and must be ordered separately – one remote is capable of programming an entire hospital of televisions. Please order programming remote control part number PD108-420.

Remote Control



Before you use the remote controller, please install the batteries.

- 1 POWER**
Turns the TV on or off.
- 2 MUTE**
Turns the sound on or off.
- 3 SETUP**
Displays the main menu.
Exit current OSD menu.
- 4 CH LIST**
Displays a List of the current channels programmed into the TV.
- 5 TV / AV**
Selects programmed external inputs.
- 6 TV / FM**
Selects either TV or FM Radio mode directly.
- 7 SLEEP**
Sets the sleep timer.
- 8 LAST**
Returns to the previously viewed channel.
- 9 CH ▲ ▼ (Channel Up/Down)**
Selects next channel or a menu item.

Remote Control

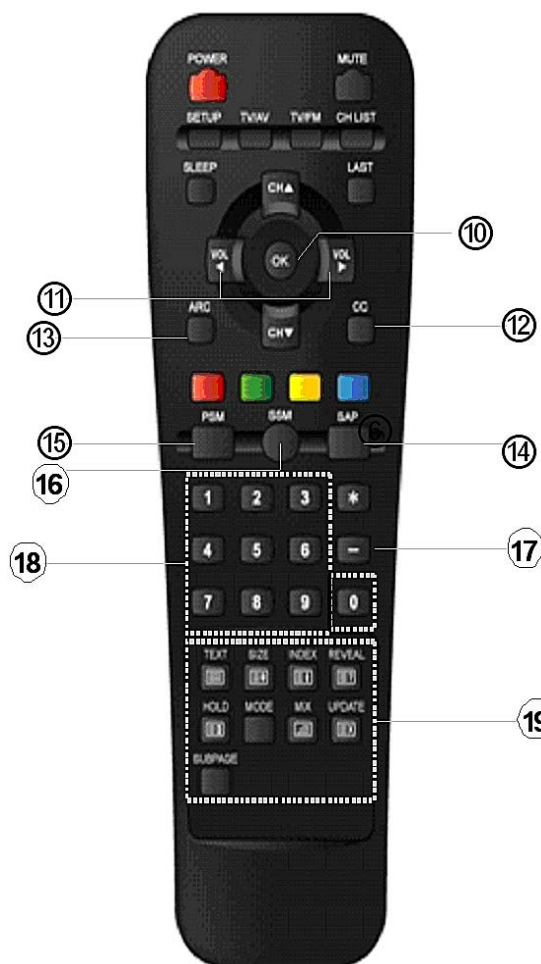

- 10 OK**
Accepts your channel selection.
Displays digital channel information.
- 11 VOL ◀▶**
Adjusts the sound level.
Adjusts menu settings.
- 12 CC**
Sets the caption function.
- 13 ARC**
Changes the aspect ratio.
Repeatedly press the ARC button to select a desired picture format.
- 14 SAP**
Adjusts the audio mode for either **MTS-Stereo**, **Mono**, or **SAP**.
- 15 PSM**
Recalls your preferred picture setting.
- 16 SSM**
Recalls your preferred sound setting.
- 17 DASH**
Press to select DTV (Digital TV) channels.
For example, to select channel 54-3, press 54, then press '-' and then 3.
- 18 NUMBERS**
Selects channel numbers.
- 19 TELETEXT**
Navigates teletext displays.
Teletext is not actively used in the USA.

Installation

LOCATION GUIDELINES

The model PDI-P22LCDC Hospital Grade LCD TV is a specialized LCD television. This TV is intended for entertainment and educational purposes for use in a hospital, a nursing home, a medical-care center, or a similar health-care facility in which installation is limited to a non-hazardous area in accordance with the National Electrical Code, ANSI/NFPA 70. The PDI-P22LCDC is designed for mounting to PDI manufactured mounts. Installation of the TV on any other mount is not recommended.



WARNING: The TV's VESA mounting holes are designed for M4 metric screws only. Use of a non-PDI approved mount or SAE hardware could result in a condition where the TV could unexpectedly fall and cause injury or death.

The PDI-P22LCDC TV mounts at the foot of a patient's bed with the supplied bracket. Select a location that is near an AC wall outlet and that does not expose the TV to bright room lights or sunlight if possible. The LCD TV also requires connection of both CATV cable signal and across-room wiring for the pillow speaker.

OSHPD (State of California Only)

The combined weight of the PDI-P22LCDC TV and PDI wall mount totals less than 20 pounds. At the time of this writing, the involvement of a written, submitted, reviewed, and approved plan by OSHPD is not required to install the PDI-P22LCDC TV in the state of California.

CABLE SYSTEM GROUNDING

The coax cable system connected to the PDI-P22LCDC TV should be grounded in accordance with the National Electrical Code, ANSI/NFPA 70. The code provides guidelines for proper grounding and, in particular, specifies that the cable ground shall be connected to the grounding system of the building, as close to the point of the cable entry as practical.

Wall Mounting on Bracket

1. Refer to Figure 1. Select a location on the wall approximately 8 inches below the ceiling.

NOTE: Do not locate AC, Across-Room Wiring, and CATV Signal outlets below the Wall Bracket's location as it will cause clearance issues and interfere with the TV's cabinet when mounted to the bracket.

Position the Wall Bracket and locate two mounting holes. Secure the bracket to the wall (mounting hardware is not included).

2. Refer to Figure 2. Position the Back Mount on the LCD TV cabinet. Attach with four M4 screws provided.
3. Mate the Back Mount to the Wall Bracket making sure the pivot pins are retained in the "U" shaped slot. Using the pilfer security driver packed with the hardware, secure with two 10x32 pilfer screws.
4. Connect the AC line cord, Pillow Speaker Jumper Cable, and CATV Coax Cable.
5. The TV's tilt can be adjusted by loosening both Pilfer Screws, adjusting tilt, and then tighten.

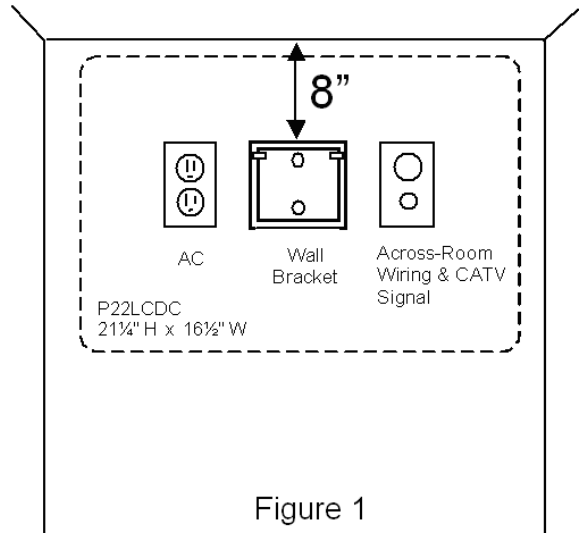

Wall Mounting on Standard Bracket

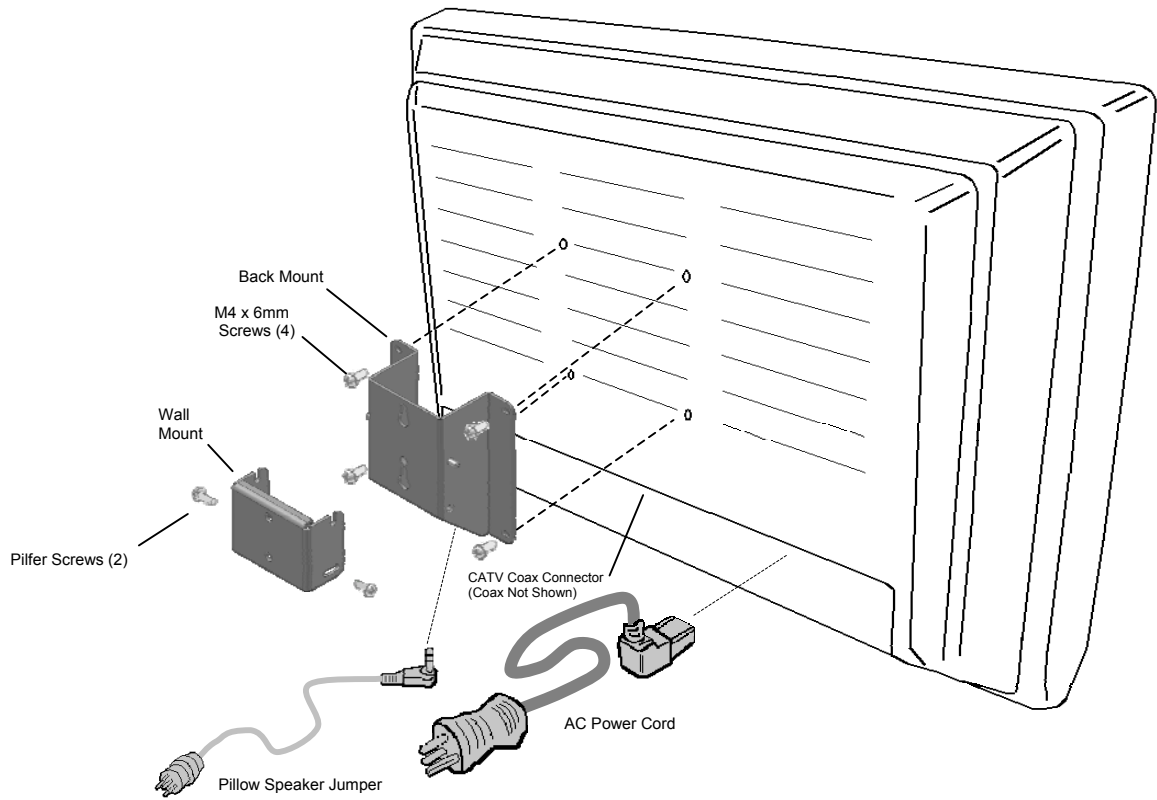

Note: Make sure the **pillow speaker selection switch** is set to the correct setting before plugging in the jumper.

The switch changes the voltage supplied to the pillow speaker, and could overdrive the pillow speaker if incorrectly set

Figure 2

Across-Room Wiring

A ¼" stereo style pillow speaker (pendant control) jack is located on the TV's connector panel on the backside. This TV is designed to work with either a digital pillow speaker that generates digital style control codes or a single-button analog (switch-style) pillow speaker. A rear panel mounted switch allows use of different brands of pillow speakers and supports the major brands; Zenith, Philips, and RCA pillow speakers. Please refer to the "Pillow Speaker" section elsewhere in this manual for details.



WARNING: DO NOT connect the pillow speaker circuit Common to earth ground. Grounding of the Common will defeat the isolation circuitry of the television and possibly expose the patient to harmful shock currents should a wiring fault occur.

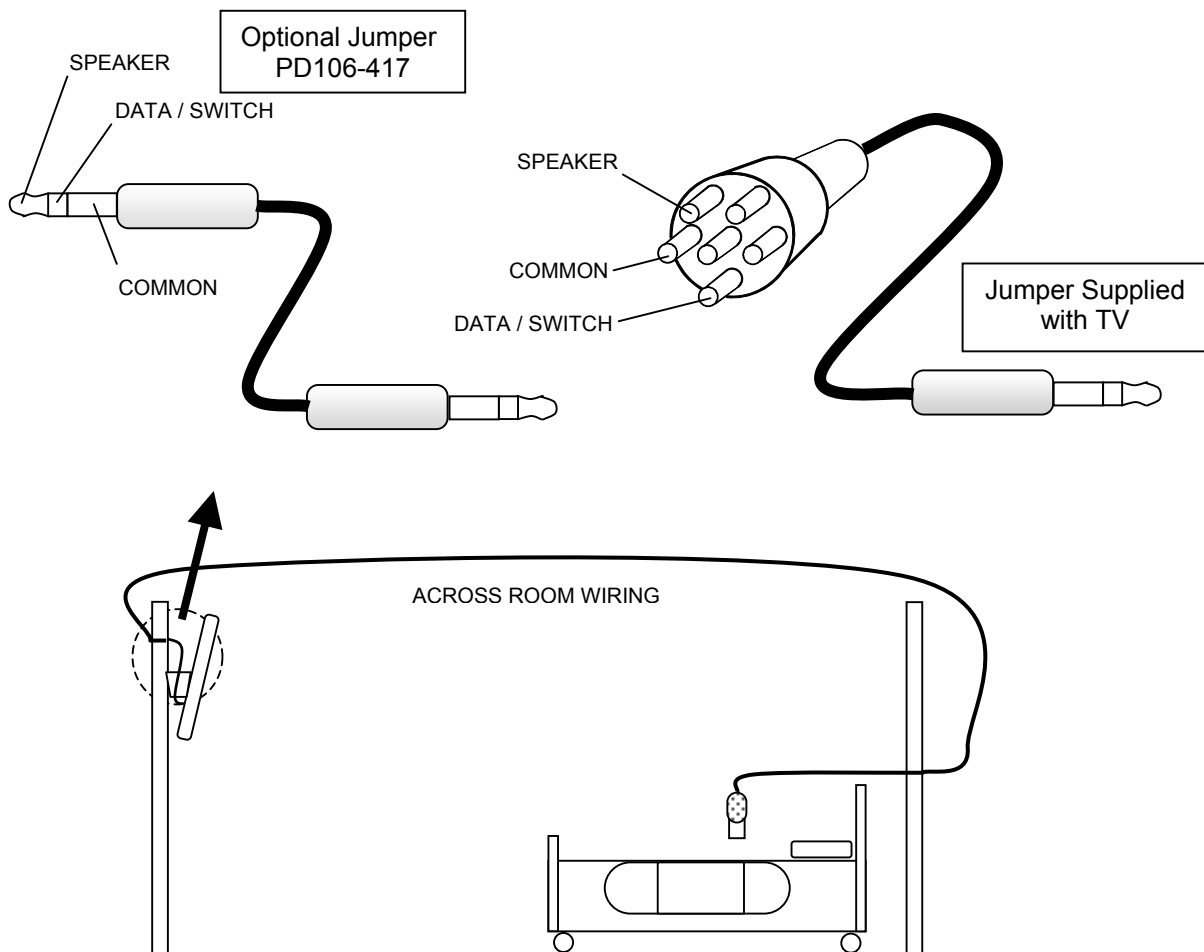

Connections

Antenna “ANT” Connection



CAUTION: Some hospital cable systems provide power voltage on the coaxial cable. This TV is NOT designed to be powered via a coaxial cable. Do not connect to a powered coaxial cable. Damage will result to the TV.

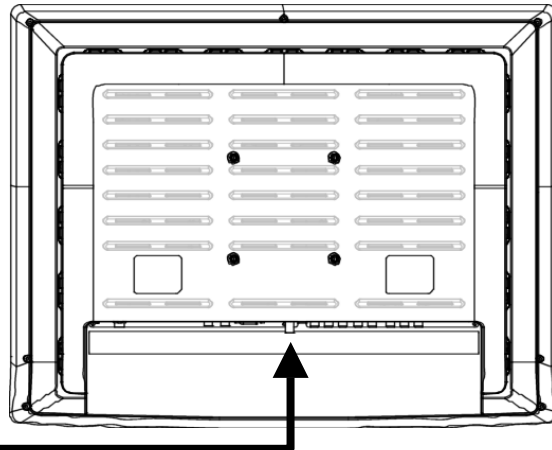

Hospital Coax Cable

A/V IN

Connects composite video, and stereo or mono audio from devices such as VCR's, DVD's, and Game Boxes.

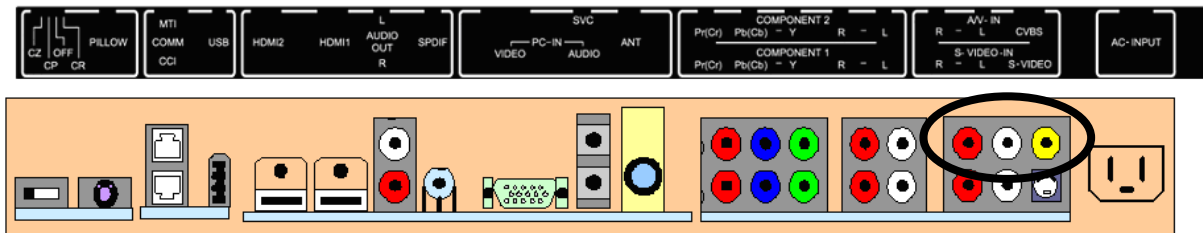

1. Connect the audio outputs from the device (L, R) to the A/V-IN L(MONO) & R on the TV. Connections are color code.
2. Connect the video output from the device to the A/V-IN VIDEO on the TV. Connection is color-coded.
3. Verify that the COMPOSITE VIDEO mode is enabled in the Source Setup menu. Please see “Source Setup” instructions elsewhere in this manual for details.
4. Press the TV/AV button repeatedly until COMPOSITE VIDEO appears in the lower right corner of the screen indicating selection of A/V-IN.
5. Activate the device.

Connections

S-VIDEO Connection

If the external equipment you connect has an S-VIDEO jack, you can use an S-VIDEO cable for improved picture quality (compared to an A/V cable).

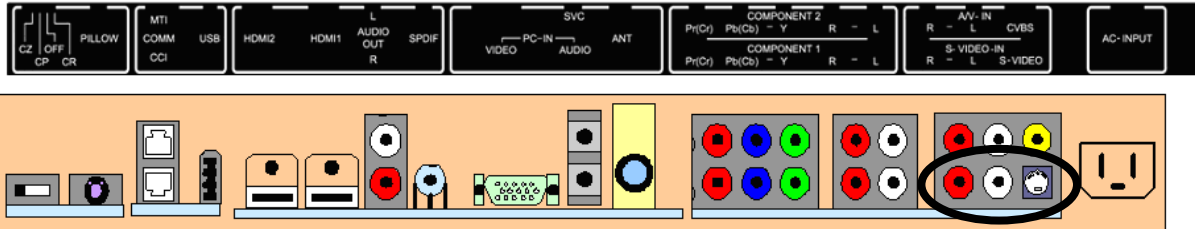

1. Connect the VCR's S-Video output directly to the TV's S-VIDEO connector.
2. Connect the VCR's L & R audio to the TV's L & R connector inputs.
3. Verify that the S-VIDEO mode is enabled in the Source Setup menu. Please see "Source Setup" instructions elsewhere in this manual for details.
4. Press the TV/AV button repeatedly until S-VIDEO appears in the lower right corner of the screen indicating selection of S-VIDEO.
5. Activate the VCR. The VCR playback picture appears on the screen.

Component1 / Component2 IN

The TV supports two inputs for devices such as a DVD that offer Component type signals.

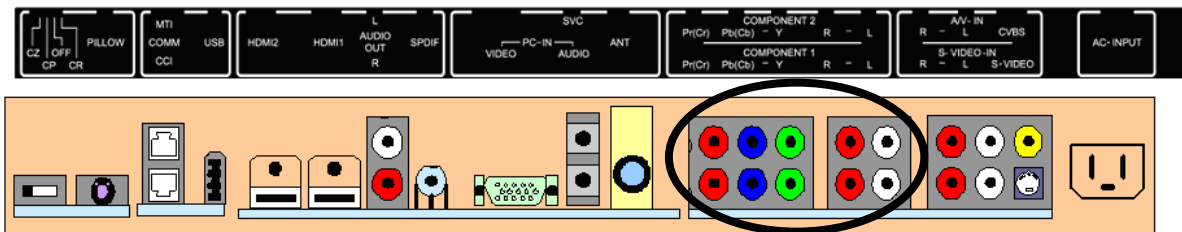

1. Use a component video cable to connect the DVD player's Y/Pb/Pr jacks to the TV's component Y/Pb(Cb)/Pr(Cr) jacks.
2. Use an audio cable to connect the DVD player's Audio OUT jacks to the TV's Audio IN jacks. Be sure to use the appropriate audio inputs adjacent to the corresponding Video input.
3. Verify that the appropriate component input is select (Component 1 or Component 2) is enabled in the "Source Setup" menu. Please see "Source Setup" instructions elsewhere in this manual for details.
4. Press the TV/AV button repeatedly until COMPONENT 1 or COMPONENT 2 appears in the lower right corner of the screen indicating selection of the component input.
5. NOTE: The Y/Pb/Pr jacks on your DVD player are sometimes labeled Y/Cb/Cr or Y/B-Y/R-Y. If so, connect the cables to like colors.
6. Activate the DVD. The DVD playback picture appears on the screen.

Connections

AUDIO OUT

Audio from the current selected device can be outputted to an amplifier, external speakers, or other similar device.

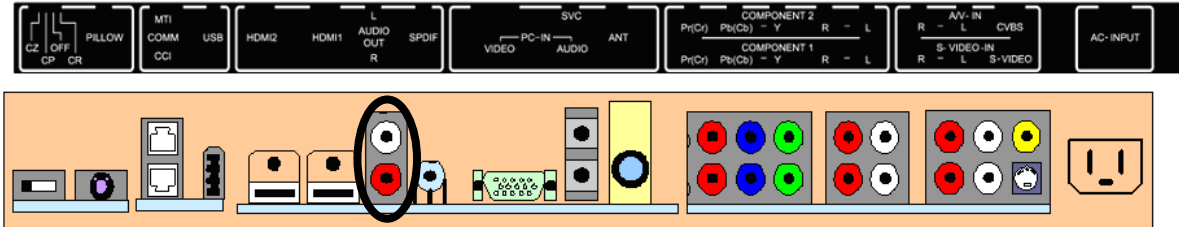

1. Use an audio cable to connect the television's AUDIO OUT jacks to the external devices input jack.
2. Activate the device.

Pillow Speaker

The pillow speaker (pendant control) jack is located on the TV's connector panel. Control of the TV using an externally wired pillow speaker is possible. Please see the "Installation" section elsewhere in this manual for wiring details.

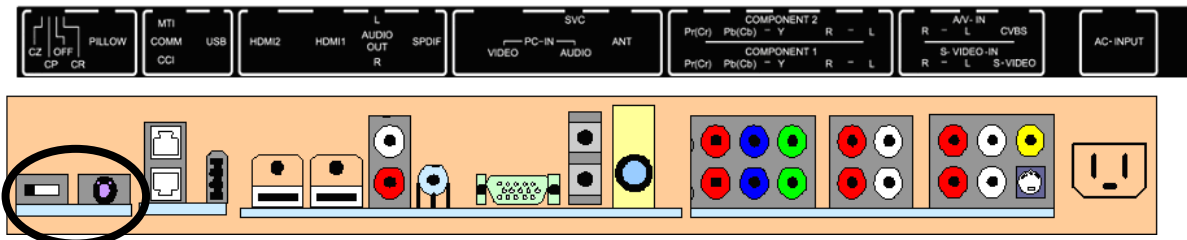

1. Select the appropriate brand of digital pillow speaker using the recess slide switch next to the PILLLOW jack.
 CZ for Zenith[®]
 CP for Philips[®]
 CR for RCA[®]
 OFF to disable the pillow speaker
 For analog style pillow speakers set the switch to either CZ, CP, or CR.

NOTE: The TV is shipped from the factory with the switch in the OFF position.

	<p>CAUTION: Confirm pillow speaker type and set the slide switch appropriately BEFORE connection the pillow speaker to the TV. Failure to follow this procedure could result in damage to the pillow speaker and / or TV.</p>
---	--

2. Connect the pillow speaker to the PILLLOW jack.
3. Operate the pillow speaker and verify correct control.

Zenith is a trademark of the Zenith Electronics Corporation, All Rights Reserved.
 Philips is a trademark of Koninklijke Philips N.V. All rights Reserved.
 RCA is a trademark of the RCA Corporation. All Rights Reserved.

Connections

HDMI 1 / 2 INPUTS

Two separate inputs are available for High Definition Multimedia Interface (HDMI) style signals.

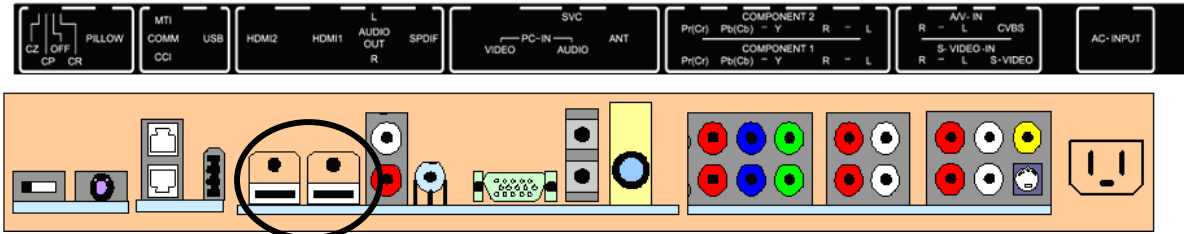

S

1. Connect the HDMI output from the external device to either HDMI1 or HDMI2 on the TV.
2. The external device's audio may be connected via the HDMI port, PC audio, Component 1 audio, or Component 2 audio inputs. The audio input must then be set accordingly in the Sound menu using the respective HDMI 1 (2) Audio Port source setting.
3. Verify that the HDMI 1 or HDMI 2 source is enabled in the Source Setup menu. Please see "Source setup" instructions elsewhere in this manual for details.
4. Press the TV/AV button repeatedly until the appropriate input HDMI 1 or HDMI 2 appears in the upper right corner of the screen indicating selection of the HDMI input.
5. Activate the external device.

Connections

PC IN

The TV can also be used as a computer monitor.

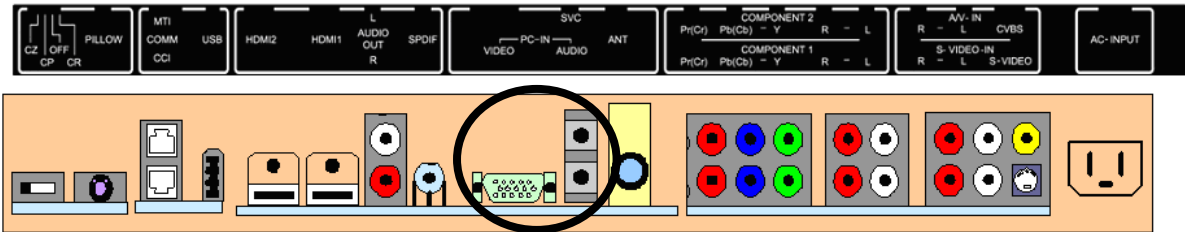

S

1. Connect the computer's video cable to the PC IN D-SUB socket on the set.
2. Connect the computer's audio cable to the PC-AUDIO jack on the set.
3. Verify that PC-ANALOG is enabled in the "Source Setup" menu. Please see "Source Setup" instructions elsewhere in this manual for details.
4. Press the TV/AV button repeatedly until PC-ANALOG appears in the lower right corner of the screen indicating selection of PC-ANALOG input.
5. Switch on the computer. The computer's screen should appear on the set.

Supported Resolution

Mode	Resolution	Horizontal frequency (KHz)	Vertical frequency (Hz)
VGA	640 x 480	31.5 KHz	60 Hz
SVGA	800 x 600	37.9 KHz	60 Hz
XGA	1024 x 768	48.4 KHz	60 Hz
WXGA	1280 x 768	47.4 KHz	60 Hz RB
	1280 x 768	47.8 KHz	60 Hz
	1360 x 768	47.7 KHz	60 Hz

NOTE:

1. The TV automatically switches to support the resolutions shown. Selection of a non-supported resolution may result in either a poor or missing picture display.
2. If possible, use the VESA 1360 x 768, 60 Hz video mode to obtain the best image quality. If other resolutions are used, some scaled or processed pictures may appear on the screen.

Basic Operation

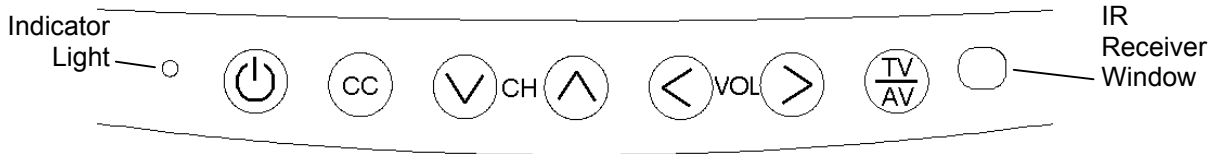

Turning the TV On and Off

1. Connect the AC power cord to the TV. A front mounted indicator light will illuminate Red indicating the TV has power, but is currently off.
2. Press the POWER button on the remote control, or the TV's ON/OFF button, or the pillow speaker's TV power button. The TV's indicator light will illuminate Green indicating the TV is turned ON. The TV's screen display requires approximately 3 seconds to warm up and display a picture.
3. Press the POWER button again to turn the TV off. A front mounted indicator light will illuminate Red indicating the TV is off.

Channel Selection

You can select a channel number with the CH▲ / CH▼ or NUMBER buttons.

NOTE: Not all pillow speaker models support direct entry of channels.

Volume Adjustment

Press the VOL◀ / VOL▶ button to adjust the sound level.

NOTE: Some pillow speakers contain only a volume wheel that may also require adjustment.

Last Channel

Press the LAST button on the remote control to view the last program you were watching.

NOTE: Some pillow speakers do not support last channel viewing.

Sound Mute Function

Press the MUTE button. The sound is switched off and the mute display  appears.

To cancel mute mode, press the MUTE button again, or press VOL◀ or VOL▶.

NOTE: Some pillow speakers do not support the mute feature.

Sleep Timer

The sleep timer turns the TV off after activation of a preset time limit.

Press the SLEEP button on the remote repeatedly to select the number of minutes. The time limit can range from 10 up to 120 minutes in value.

Basic Operation

On Screen Menu Language Selection

You can adjust the language used in displaying the (OSD) on screen display.

1. Press the SETUP button on the remote control.
2. Press the CH ▲ / CH ▼ button to select the OSD Language menu.
3. Press the ◀▶ button to select your desired language.



4. Press the SETUP button to exit the main menu.

Changing the Source Input

The TV can be switched to other display modes such as VCR, DVD, PC, or other externally connected devices.

1. Press the TV/AV button to change to another source input.

NOTE: The desired source input must be enabled in the Source Setup menu. Please see "Source Setup" instructions elsewhere in this manual for details.

2. Alternatively, press CH ▲ / CH ▼ buttons until reaching the highest channel (or below to the lowest channel). All activated sources will appear in the channel table above the highest channel and is directly viewable.

NOTE: The "Channel to Other Sources" must be enabled in the FEATURES menu to allow top of channel display of activated sources.

On Screen Menus and Displays

The TV is programmed using the Menus.

1. Press the SETUP button on the IR remote control to display the main SETUP menu.
2. Press the CH▲ / CH▼ buttons to select a menu item.
3. Adjust or enter the menu item using the VOL◀ / VOL▶ buttons.
4. Press the SETUP button on the IR remote control to return to the preceding menu.

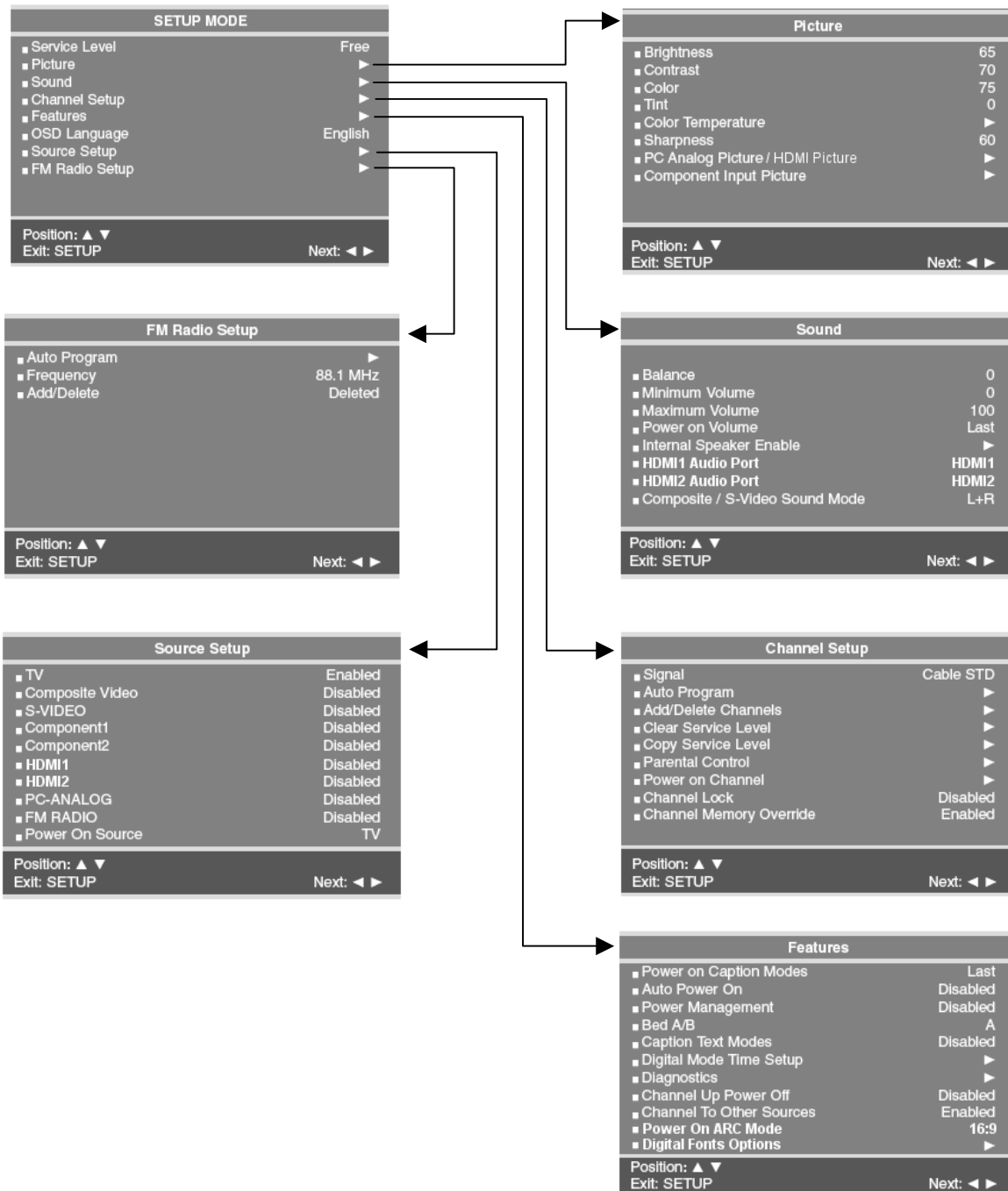

Service Level

Service Level

The TV can be configured with 3 different banks of channels called Service Levels. Each Service Level can be programmed with any combination of channels. For example, a hospital usually elects to dedicate one of the service levels for Pediatrics and another for Maternity since additional or banned channels may be found in either location that would not be normally shown to the general patient population. A DISABLED service level is also available that does not display any channels but rather a disabled message on the TV's screen when the TV is turned on.

To change a Service Level.

1. Press the MENU button to display the SETUP menu.
2. Press the CH▲ / CH▼ buttons to highlight the Service Level item.
3. Press the VOL◀ / VOL▶ button to select the desired service level.
4. Press the MENU button or TV/AV button to exit.

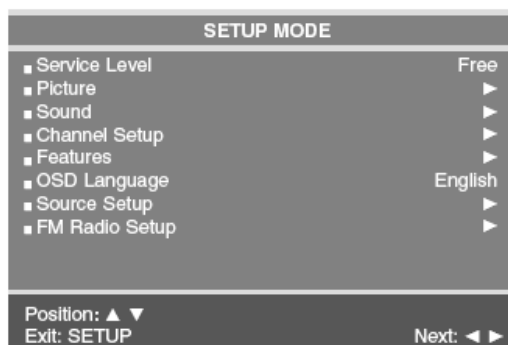

NOTE: If a service level is selected that is empty, and has not been programmed with channels, a warning message will be displayed on the TV stating "No Channels Available, Please Contact a TV Representative." To eliminate this message switch the TV to a Service Level that has been programmed with channels.

Picture

Adjustment of picture Brightness, Contrast, Color, Tint, Color Temperature and Sharpness is available to customize the levels you prefer using the on-screen menus. Alternately, PDI factory preset picture modes can be selected using the remote control.

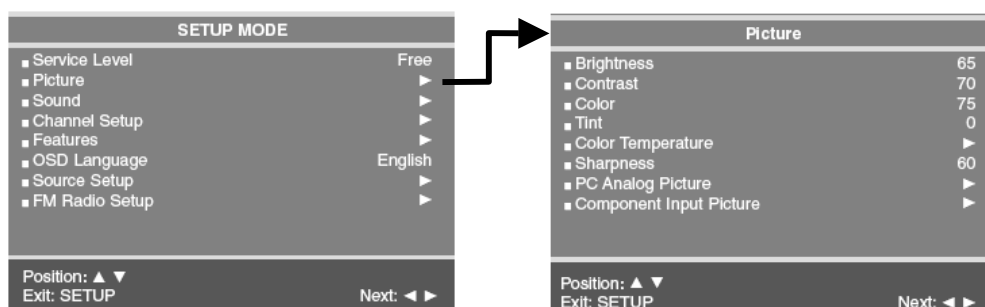

1. Press the MENU button to display the SETUP menu.
2. Select the Picture menu item.
3. Press the CH▲ / CH▼ buttons to highlight the desired picture item.
4. Adjust the picture item using the VOL◀ / VOL▶ buttons to the desired level.
5. Press the MENU button to store the picture values.

NOTE: A separate set of picture parameters are available for computer (PC Analog Picture) or external devices such as DVD's (Component Input Picture).

Picture Controls

Color Temperature

The color temperature menu appears only when the P22LCDC is in TV, Composite Video, or S-Video modes. “Standard”, “Reddish”, “Greenish”, “Bluish” color temperatures are available for selection, however the individual colors are not adjustable. The “USER” setting allows individual adjustment of each of the TV’s primary colors. The color temperature setting is best set using a calibrated signal source capable of generating a test signal containing both pure white and pure black picture components.

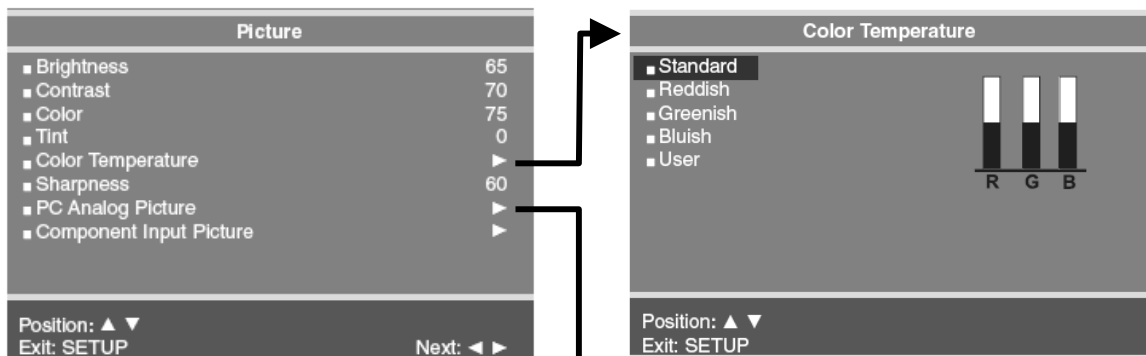

PC Analog Picture

Adjustment of a computer’s displayed picture can be made only when the TV is in “PC-Analog” mode.

Temperature

Temperature is a measure of the warmth of an image. Two temperatures are available 6500K or 9300K.

Clock

The Clock adjustment is used to minimize any vertical bars or stripes visible on the screen’s background. Adjustment of the clock setting also changes the horizontal screen size.

Phase

The Phase adjustment removes any horizontal noise and is helpful in sharpening text characters.

ARC (Aspect Ratio Control)

Selects the ratio of the screen size (Horizontal : Vertical); 4:3, 14:9, or 16:9.

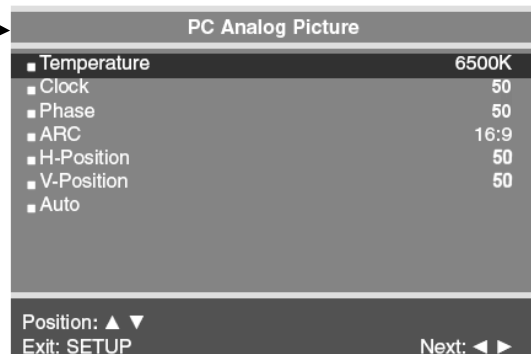

H-Position (Horizontal Position)

The H-Position moves the picture left or right across the screen.

V-Position (Vertical Position)

The V-Position moves the picture up or down across the screen.

AUTO

Automatic adjustment of screen position, clock, and clock phase.

Picture Controls

Component Input Picture

When the TV's source is set to Component Input additional picture adjustments are available.

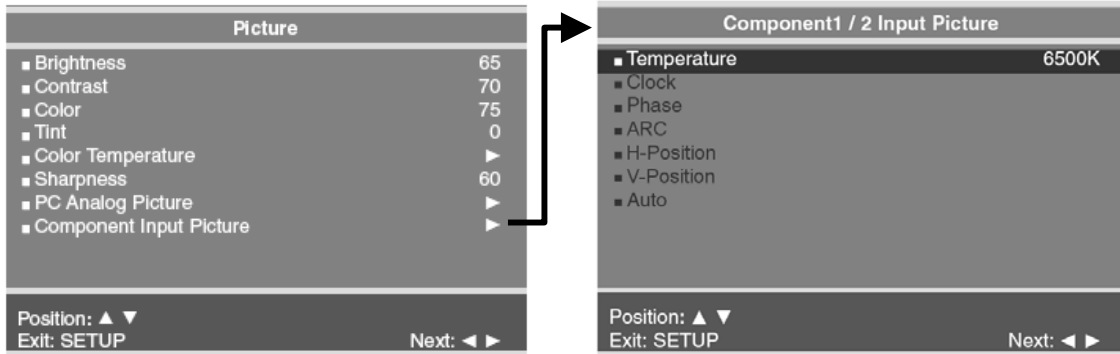

Temperature

Temperature is a measure of the warmth of an image. Two temperatures are available 6500K or 9300K.

Sound Control

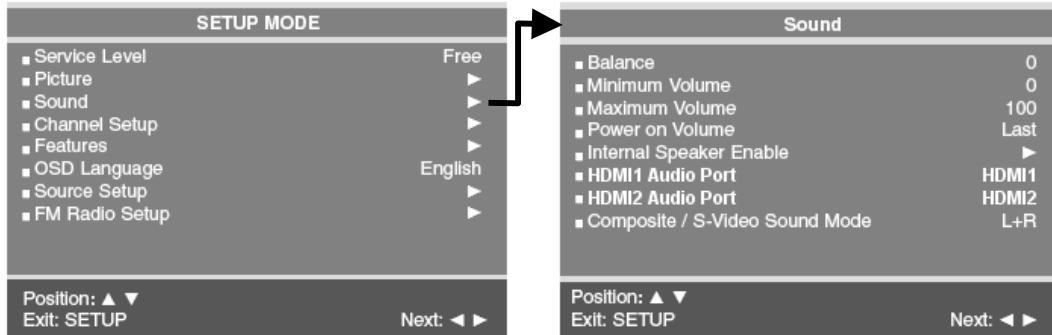

Sound

The Sound menu allows very precise adjustment of several sound parameters.

Balance

Adjusts the sound balance from the left and right speakers mounted in the TV. Balance has no effect on the pillow speaker sound.

1. In the Sound menu, press the CH▲ / CH▼ button to select Balance.
2. Press VOL◀ / VOL▶ to adjust the sound balance from the TV.
3. Press the SETUP button to return to the preceding menu.

Minimum Volume

Sets the minimum volume level the TV can reach. Setting this to any value other than 0 guarantees that some level of sound will always be heard when the TV is operating.

1. In the Sound menu, press the CH▲ / CH▼ button to select Minimum Volume.
2. Press the VOL◀ / VOL▶ button to select your preferred minimum volume with the TV turns on.
3. Press the SETUP button to return to the preceding menu.

Maximum Volume

Sets the maximum volume level the TV can reach. This setting is useful for the hard-of-hearing patient who causes disturbance.

1. In **Sound** menu, press the CH▲ / CH▼ button to select Maximum Volume.
2. Press the VOL◀ / VOL▶ button to determine your preferred maximum volume allowed.
3. Press the SETUP button to return to the preceding menu.

Power On Volume

Sets the initial volume the TV starts at upon powering on. Once the TV is on, the volume can be set to any allowable level.

1. In Sound menu, press the CH▲ / CH▼ button to select Power on Volume.
2. Press the VOL◀ / VOL▶ button to determine your preferred volume when the TV turns on. Setting the level to LAST causes the TV to remember the last volume level used by the TV prior to turning off.
3. Press the SETUP button to return to the preceding menu.

Sound Control

Internal Speaker Enable

The speaker's inside the TV's cabinet can be turned on or off for either different TV Service Level or Source modes. Note: Sound to an attached pillow speaker remains on at all times.

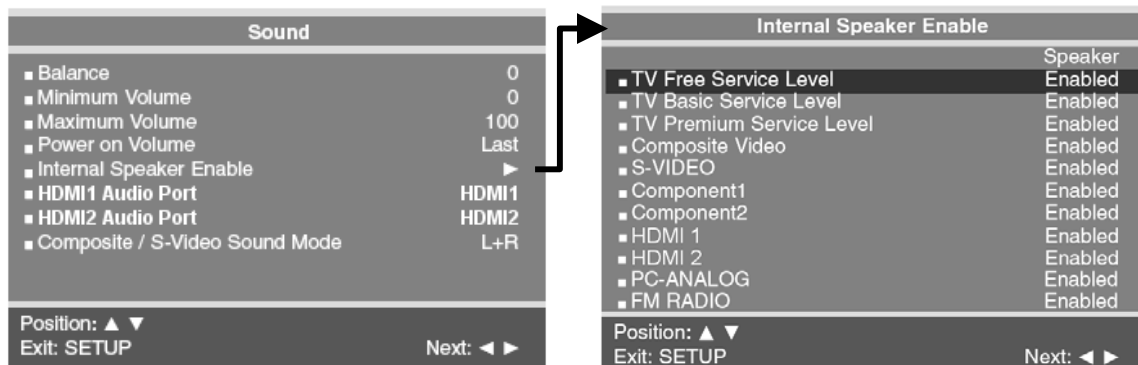

1. In the Sound menu, press CH▲ / CH▼ button to select the Internal Speaker Enable menu item.
2. Press the CH▲ / CH▼ button to select the desired Service Level(s) or Sources.
3. Press VOL◀ / VOL▶ to select Disable or Enabled.
4. Press the SETUP button to return to the preceding menu.

HDMI 1 / 2 Audio Port

Sound can be inputted to one of several other inputs when the TV is set to HDMI video.

1. In the Sound menu, press CH▲ / CH▼ button to select either HDMI1 Audio Port or HDMI2 Audio Port.
2. Press VOL◀ / VOL▶ to select either HDMI 1, PC, Component 1, or Component 2 inputs for audio while using HDMI video.
3. Press the SETUP button to return to the preceding menu.

Composite / S-Video Sound Mode

The sound mode for the Component and S-Video sources can be set independently.

1. In Sound menu, press the CH▲ / CH▼ button to select Composite / S-Video Sound Mode.
2. Press VOL◀ / VOL▶ to select L+R, L+L or R+R.
 L+R : Audio signal from audio L input is sent to left loudspeaker and audio signal from audio R input is sent to right loudspeaker.
 L+L : Audio signal from audio L input is sent to left and right loudspeakers.
 R+R : Audio signal from audio R input is sent to left and right loudspeakers.
3. Press the SETUP button to return to the preceding menu.

Channel Setup

Channel Setup

The TV offers three different programmable channel banks or Service Levels. Programming is only accomplished using the handheld remote control.

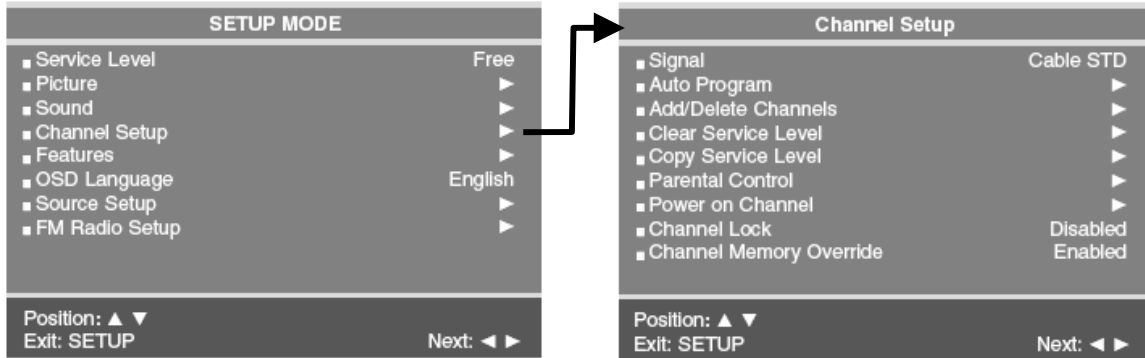

Signal

Four different tuning types are available depending upon the healthcare facility's signal style. Selection of the correct signal type is required for the TV to recognize all possible channels and before any channel programming can begin.

1. Press the SETUP button to display the SETUP MODE menu.
2. Press the CH▲ / CH▼ button to select Signal.
3. Press VOL◀ / VOL▶ to select Air, Cable STD, Cable IRC or Cable HRC. NOTE: Most hospitals use the Cable STD signal style.

Channel Setup

Auto Program

The TV automatically scans each available channel for activity. Channels that display activity are memorized into the selected Service Level.

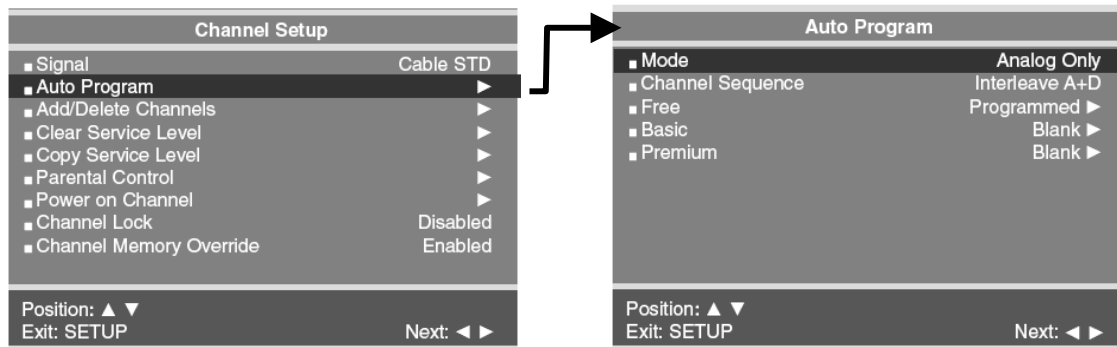

1. Press the SETUP button to display the SETUP MODE menu.
2. Press the CH▲ / CH▼ button to select Mode.
3. Press VOL◀ / VOL▶ to set the scope of channel scanning.
Analog Only: TV searches for analog channels only.
Digital Only: TV searched for digital channels only.
Analog and Digital: TV searches for both analog and digital channels.
4. Press the CH▲ / CH▼ button to select the Channel Sequence menu item.
5. Press VOL◀ / VOL▶ to set the Channel Sequence in which the channels are displayed after searching.
Interleave A+D: In the order of channel number regardless of the system.
All A then D: Digital channels are displayed after all analog channels.
6. Press the CH▲ / CH▼ button to select the Service Level you wish to program. The menu displays the current programming status of each level as either Programmed or Blank.
NOTE: A Programmed service level can also be re-programmed if desired.
7. Press the VOL▶ button to start auto programming.
8. A confirmation menu will appear before proceeding. Press either the CH▲ to start auto programming. Press CH▼ button to cancel the operation. The TV will now search all available channels. Auto programming may require several minutes to complete.
9. Press the SETUP button to return to normal TV viewing.

Channel Setup

Add / Delete Channels

Individual analog TV channels that are missing can be added to a Service Level. Or, analog TV channels that require deletion can be removed from a Service Level. Currently registered Digital channels can be enabled or disabled in each service level.

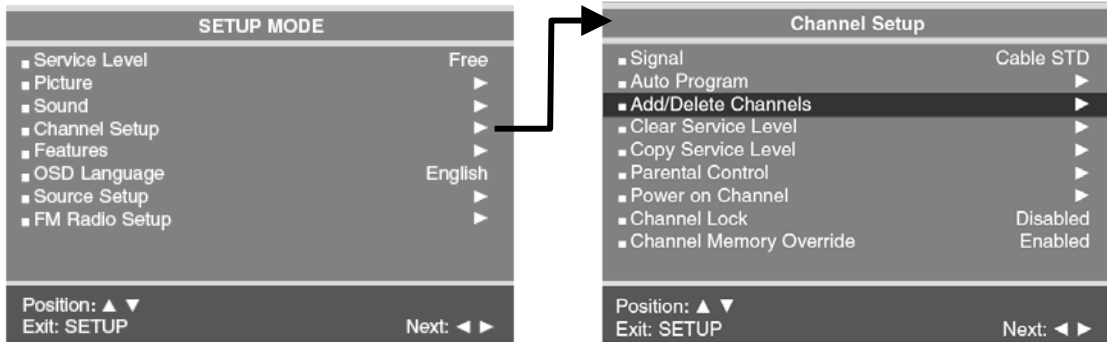

1. Press the SETUP button to display the SETUP MODE menu.
2. Press the CH▲ / CH▼ button to select Channel Setup. Press VOL◀ / VOL▶ to select.
3. Press the CH▲ / CH▼ button to select Add/Delete Channels. Press VOL◀ / VOL▶ to select.
4. Press the CH▲ / CH▼ button to select the Service Level you wish to add or delete channels.
5. Press VOL◀ / VOL▶ to enter the Add/Delete Channels menu for that Service Level.

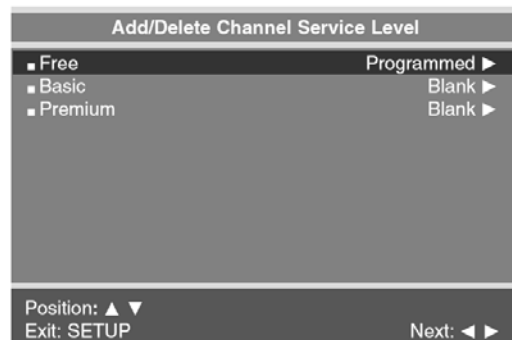

Channel Setup

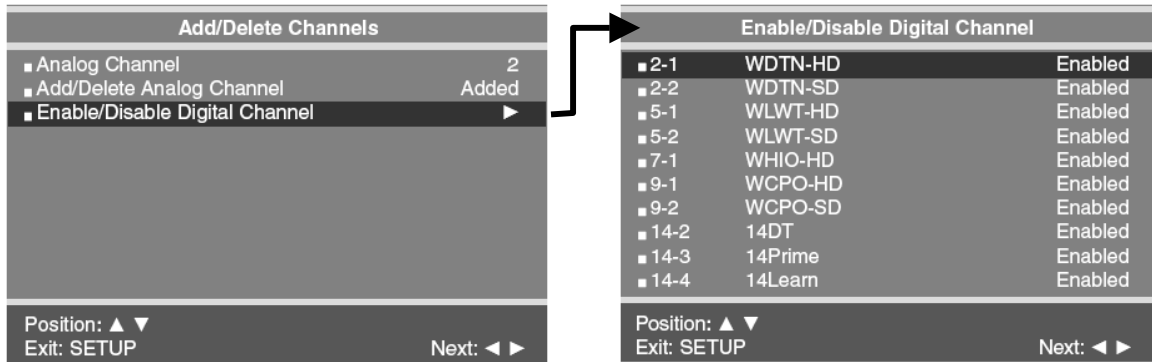

The Add/Delete Channels menu provides access to both Analog and Digital Channels.

6. Press VOL◀ / VOL▶ button to select the Analog Channel number. Then press the CH▲ / CH▼ buttons to select Add/Delete Analog Channel. Use the VOL◀ / VOL▶ button to select Added or Deleted.
7. Press CH▲ / CH▼ buttons to select Enabled/Disabled Digital Channels menu. Then press the VOL◀ / VOL▶ button to enter. A status listing of the current memorized channels is shown.
8. Select the channel to be changed using the CH▲ / CH▼ buttons. Use the VOL◀ / VOL▶ button to change the status to Enabled or Disabled.
9. Press the SETUP button to return to the preceding menu.

Channel Setup

Clear Service Level

Empties a service level of all programmed channels leaving it blank.

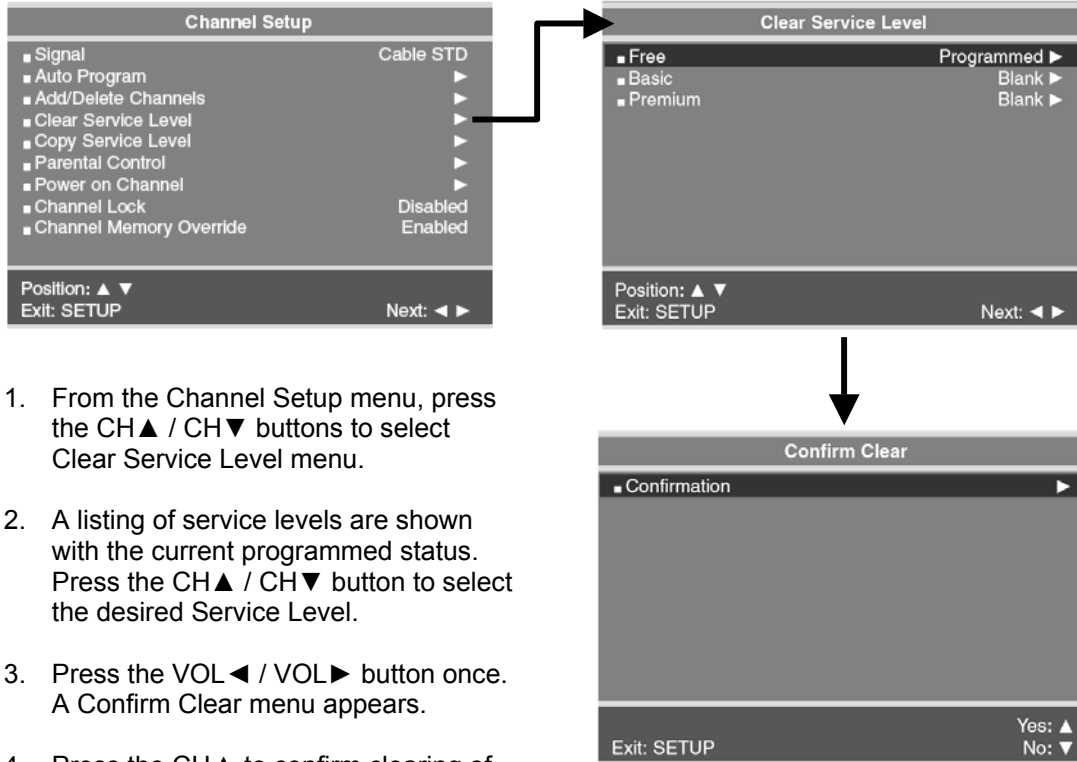

1. From the Channel Setup menu, press the CH▲ / CH▼ buttons to select Clear Service Level menu.
2. A listing of service levels are shown with the current programmed status. Press the CH▲ / CH▼ button to select the desired Service Level.
3. Press the VOL◀ / VOL▶ button once. A Confirm Clear menu appears.
4. Press the CH▲ to confirm clearing of the selected Service Level. Press the CH▼ button to exit without making any changes to the selected Service Level.
5. Press the SETUP button to return to the preceding menu.

Channel Setup

Copy Service Level

Copies one service level of another.

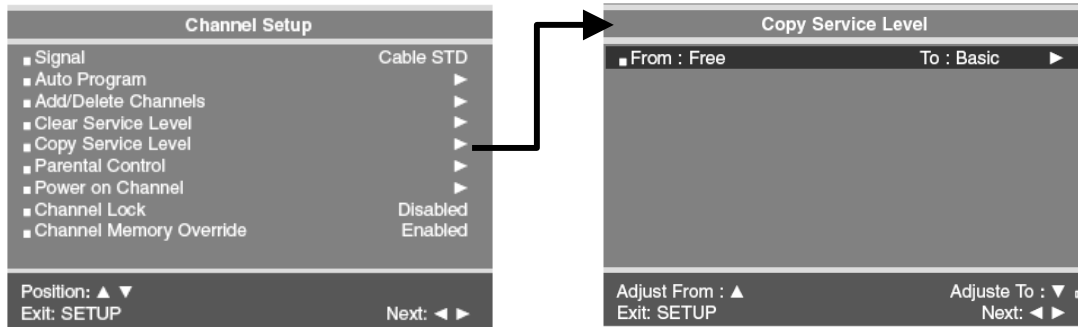

1. From the Channel Setup menu, press the CH▲ / CH▼ buttons to select Copy Service Level menu. A Copy Service Level menu appears and shows a source (From) and destination (To) Service Level.
2. Press the CH▲ button to adjust the From Service Level.
3. Press the Press the CH▼ button to select the To Service Level.
4. Press the VOL◀ / VOL▶ button once. A Confirm Copy menu appears.
5. Press the CH▲ to confirm clearing of the selected Service Level. Press the CH▼ button to exit without making any changes to the selected Service Level.
6. Press the SETUP button to return to the preceding menu.

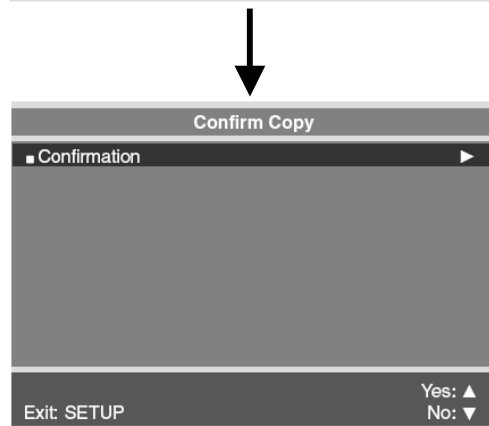

Channel Setup

Parental Control

A parental control feature is available to restrict and block undesirable programs from appearing on the TV. This feature is of particular importance for televisions installed in pediatric wards.

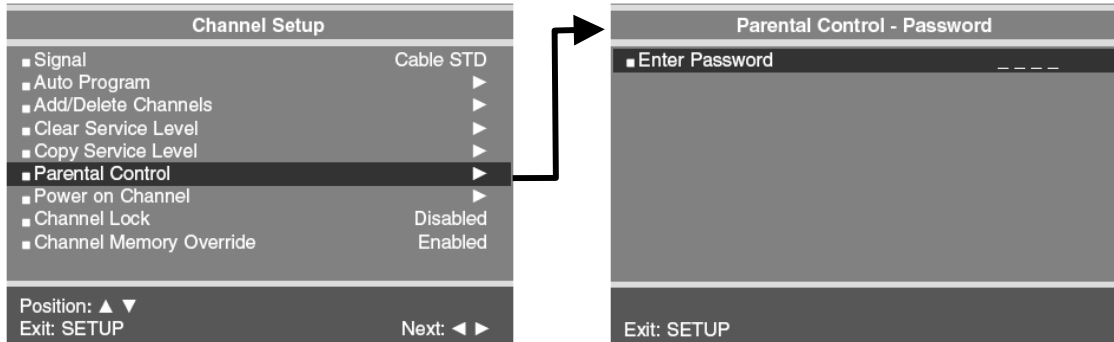

If the Parental Lock is Enabled in Parental Control menu, an Enter Password screen will appear. The default setting is Disabled.

1. In Channel Setup menu, press the CH▲ / CH▼ buttons to select Parental Control menu.
2. Using an IR remote control, enter the four digit password. An "X" will be echoed as each number is entered. The default input password for a new TV set is "0000". If the wrong password is entered, return to the Channel Setup menu and try again.
3. You may exit at any time by pressing the SETUP button to return to the preceding menu.

	<p>IMPORTANT: If the password is forgotten, it can be reset to "0000" by pressing the front panel "CC" button and the programmer remote "Setup" button simultaneously and holding both for 5 seconds.</p>
---	--

Parental Control

TV Rating

Most television programming is now rated. TV Rating allows the TV to selectively present only programming content that is unblocked per its preset level. A program that is blocked, displays a black screen only.

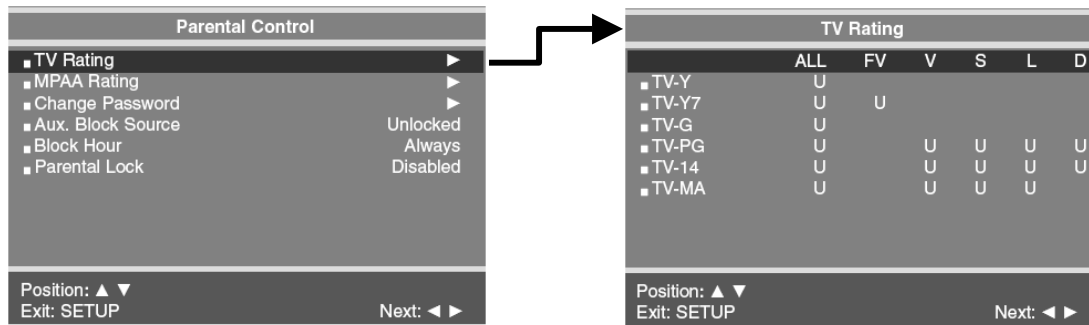

1. In the Parental Control menu, press the CH▲ / CH▼ button to select the TV Rating menu. Then press the VOL◀ / VOL▶ button to enter.
2. Press the CH▲ / CH▼ button to move to one of the six age-based categories. At this point, one of the TV-Ratings is selected. Depending on your existing setup, a letter "U" or "B" will be highlighted. (U=Unblocked, B=Blocked).
3. While the "U" or "B" is highlighted, press the CH▲ / CH▼ buttons to block or unblock the category.
4. Select one of these TV-Ratings: TV-Y, TV-Y7, TV-G, TV-PG, TV-14 or TV-MA. Then while the TV-Rating is selected, repeatedly press the VOL◀ / VOL▶ buttons. This will cycle through the available sub-ratings (ALL, FV, V, S, L or D). A highlighted letter ("U" or "B") will be displayed for each sub-rating. While the "U" or "B" is highlighted, press the CH▲ / CH▼ button to change the sub-rating. To select a different TV-Rating, press the CH▲ / CH▼ buttons with cursor in the first column.
5. Press the SETUP button to return to the preceding menu.

Parental Control

MPAA Rating

Most televised movies are now rated. MPAA Rating selectively allows the TV to only present movie content that is unblocked per its preset level.

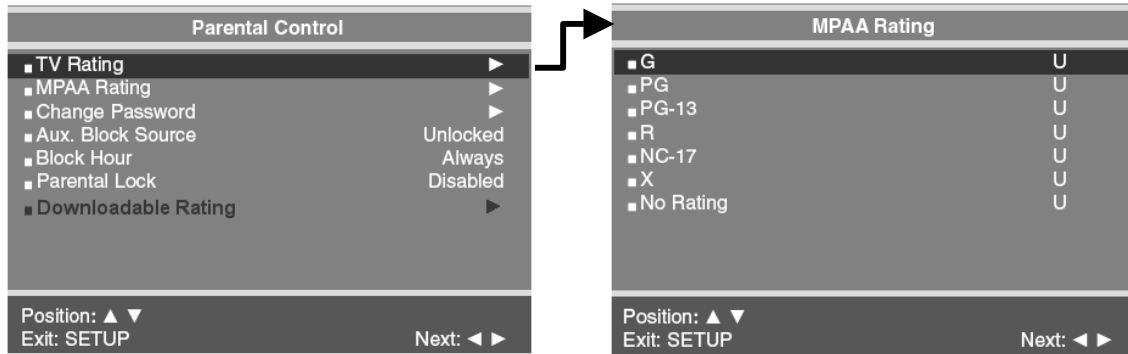

1. In Parental Control menu, press the CH▲ / CH▼ button to select the MPAA Rating menu. And then press the VOL◀ / VOL▶ button to enter.
2. Press the CH▲ / CH▼ button to select a particular MPAA Rating.
3. While a particular category is selected, press the VOL◀ / VOL▶ buttons to active it. A highlighted letter ('U' or 'B') will be displayed. Press the CH▲ / CH▼ button to change the 'U' or 'B'. The TV displays a black screen for a blocked movie.
4. Press the SETUP button to return to the previous menu.

NOTE: Parental Control will automatically block any category that is "more restrictive" For example, if you block the "PG-13" category, then "R", "NC-17" and "X" will automatically be blocked also.

Parental Control

Change Password

The Parental Control access password can be changed using this menu.

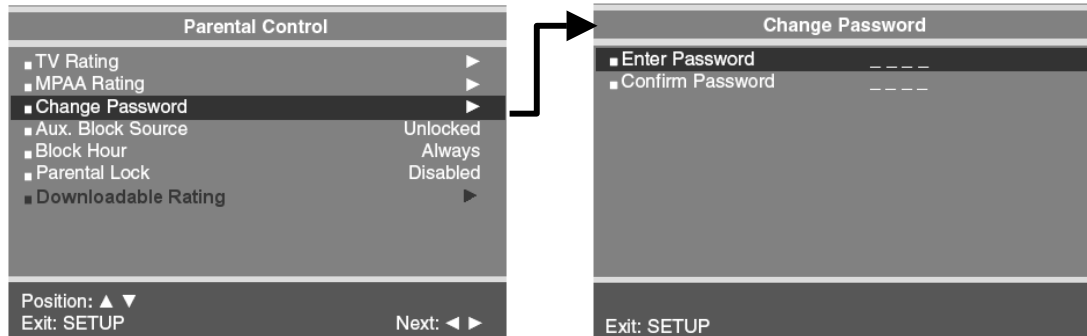

1. From the Parental Control menu, press the CH▲ / CH▼ button to select the Change Password. Then press the VOL◀ / VOL▶ button to enter.
2. Enter a new Password. Confirm the Password a second time by entering the same digits.
3. Press SETUP to return to the previous menu.

Aux. Block Source

In addition to blocking the TV's programming, the auxiliary sources can be blocked. When the TV encounters an external signal source that is not appropriate per its settings, a black screen appears with muted sound.

1. From the Parental Control menu, press the CH▲ / CH▼ button to select AUX. Block source. Then press the VOL◀ / VOL▶ button to enter.
2. Press the buttons to change the "Unblocked" or "Blocked" status.
3. Press the SETUP button to return to the previous menu.

Block Hour

Block Hours sets the amount of time in hours you want Parental Control Active.

Parental Lock

With Parental Lock On, the Parental Function is active. Turn off to disable Parental Control.

Downloadable Rating

This feature is not available for the PDI-P22LCDC model.

Movie & TV Rating Systems

MOTION PICTURE ASSOCIATION OF USA (MPAA) RATING SYSTEM

Grade		Meaning
G	General Audiences	Content not offensive to most viewers
PG	Parental Guidance Suggested	Content is such that parents may not want their children to view the program.
PG-13	Parental Strongly Cautioned	Program is inappropriate for preteens, with a greater degree of offensive material Suggested than a PG rated program
R	Restricted viewing	Not for children under age 17. Strong elements of sex and/or violence.
NC-17	No Children under age 17	Not for children under age 17 under any circumstances. Strong sexual content.
X	Hard Core Films	Same as NC-17 rating.
No Rating	No Rating	MPAA Not Rated

TV PARENTAL GUIDELINE RATING SYSTEM

Grade		Meaning
TV-Y	Young Children	Content not offensive to most viewers
TV-Y7	Children 7 and over	Considered suitable for children over 7, may contain Fantasy Violence Scenes.
TV-G	Parental Audience	Considered suitable for all audiences; children may watch unattended.
TV-PG	Parental Guidance	Suggested Unsuitable for younger children, may contain: Suggestive Dialog, Bad Language, Sex, and Violence Scenes
TV-14	Parents Strongly Cautioned	Unsuitable for children under 14, may contain: Strong Dialog, Bad Language, Sex, and Violence Scenes.
TV-MA	Mature Audience Only	Adults only, may contain: Strong Dialog, Bad Language, Sex, and Violence Scenes.

NOTE

The V-Chip will automatically block certain categories that are 'more restrictive'. If you block TV-Y category, then TV-Y7 will be automatically blocked. Similarly, if you block TV-G category, then all the categories in the 'young adult' will be blocked; (TV-G, TV-PG, TV-14 and TV-MA).

The sub-rating of TV rating

Grade	Meaning
FV	Fantasy Violence
V	Violence
S	Sexual Situation
L	Adult Language
D	Sexual Suggestive Dialog

Channel Setup

Power On Channel

Displays a fixed channel each time the TV is turned on. This feature is useful for hospitals that have a Welcome Channel and wish to have it displayed upon initial use of the TV. The patient can then tune to any other available channel.

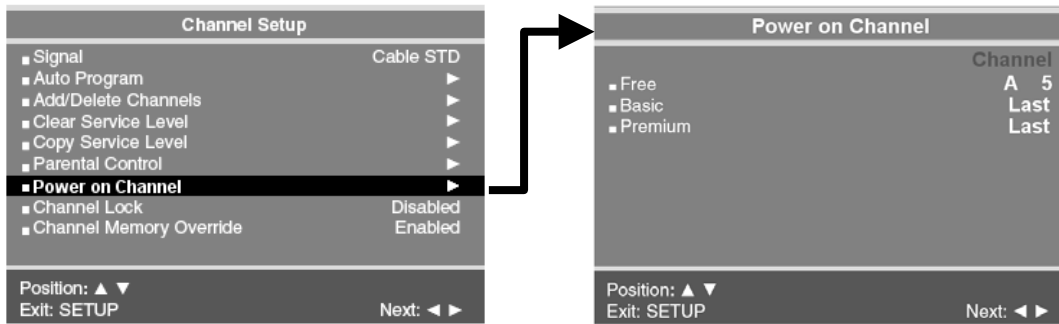

4. From the Channel Setup menu, press the CH▲ / CH▼ button to select the Power On Channel. Then press the VOL◀ / VOL▶ button to enter.
5. Press the CH▲ / CH▼ button to select the desired service level.
6. Press the VOL◀ / VOL▶ buttons to scroll through the channels currently available in the Service Level. Select either a dedicated channel or "Last" for the last channel viewed by the patient.
7. Press the SETUP button to return to the previous menu.

Channel Lock

Locks the currently viewed channel and prevents patients from tuning to any other channel. This feature is useful when the TV is used for information display purposes.

1. From the Channel Setup menu, press the CH▲ / CH▼ button to select the Channel Lock.
2. Press the VOL◀ / VOL▶ button to Enable or Disable the Channel Lock feature.
3. Press the SETUP button to return to the previous menu.

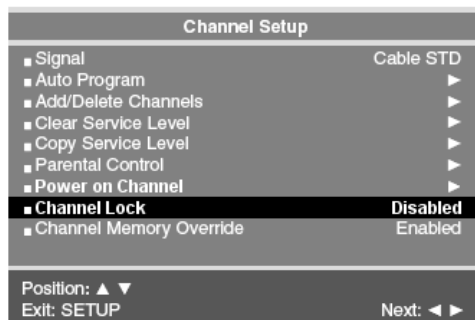

Channel Setup

Channel Memory Override

Prevents patients for tuning to a channel that is not memorized in the current Service Level memory.

1. From the Channel Setup menu, press the CH▲ / CH▼ button to select the Channel Memory Override.
2. Press the VOL◀ / VOL▶ button to Enable or Disable the Channel Memory Override feature.

DISABLED = Service Level Channels only.

ENABLED = All possible channels.

3. Press the SETUP button to return to the previous menu.

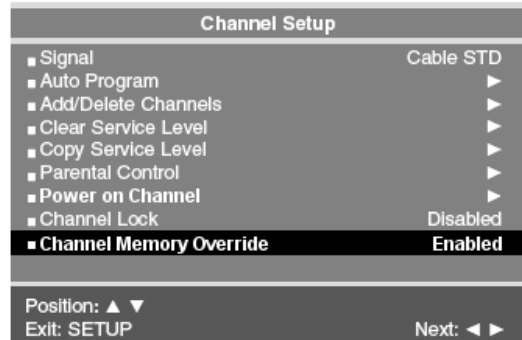

Source Setup

Enabling / Disabling Sources

The TV's signal sources can be individually Enabled or Disabled. A TV that is switched to a non-connected source generates nuisance hospital maintenance calls of "TV Not Working", when in fact the TV does work, but has been set to an inactive source. Please Disable all of the TV's sources that are not to be used.

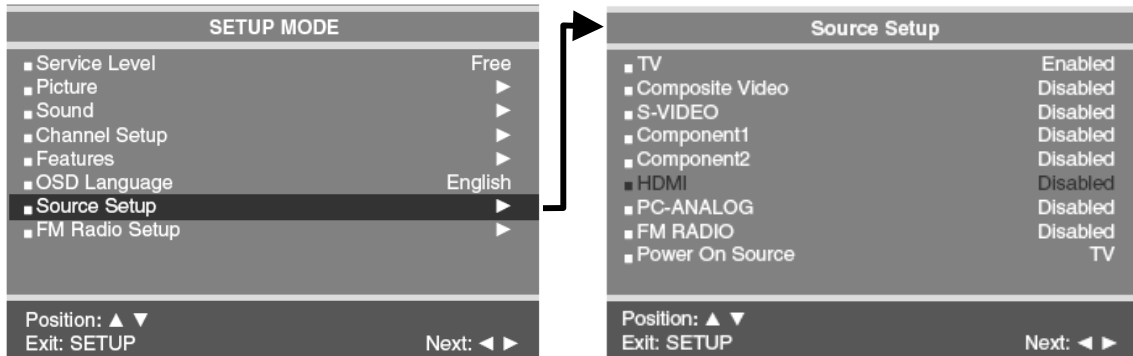

1. From the SETUP menu press the CH▲ / CH▼ button to select Source Setup. Then press the VOL◀ / VOL▶ button to enter.
2. Press the CH▲ / CH▼ buttons to select a source.
3. Press the VOL◀ / VOL▶ button to change the source status to either Disabled or Enabled as desired. NOTE: Sources that are grayed out are not installed in the TV.
4. Press the SETUP button to exit.

Power On Source

The TV can be preset to power on to a select source.

1. From the SETUP menu press the CH▲ / CH▼ button to select Source Setup. Then press the VOL◀ / VOL▶ button to enter.
2. Press the CH▲ / CH▼ buttons to select Power Con Source.
3. Press the VOL◀ / VOL▶ button to change the source. NOTE: The source must be enabled before it can be chosen as a power on source. The "LAST" entry causes the TV to power on from the "LAST" source selected.
4. Press the SETUP button to exit.

Features

The Features menu provides adjustable settings that customize the TV to your hospital.

Power On Captions Mode

Power On Captions Mode memorizes the caption setting upon powering the TV off.

Power On Captions Mode = Off, the TV will always power on with captions disabled.

Power On Captions Mode = Last, the TV powers on with the last caption's setting.

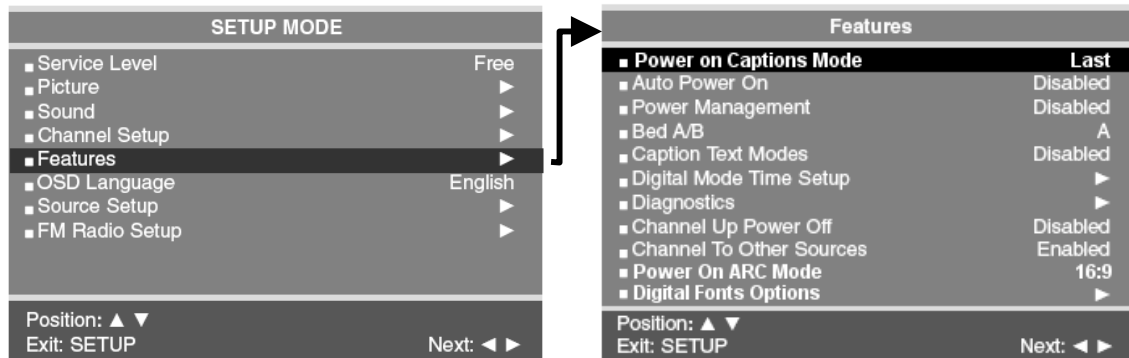

1. Press the SETUP button.
2. Press the CH▲ / CH▼ button to select the Features menu.
3. Press the CH▲ / CH▼ button to select Power On Captions Mode.
4. Press the VOL◀ / VOL▶ button to select Last or Off.
5. Press the SETUP button to return to the preceding menu.

Auto Power On

The TV will turn on and stay on whenever electrical power is applied to the set. This feature is useful for controlling the TV from a wall switch or preventing the TV from being turned off via the front TV power button, IR remote, or pillow speaker.

1. In Features menu, press the CH▲ / CH▼ button to select Auto Power On.
2. Press the VOL◀ / VOL▶ button to select Disabled or Enabled.
3. Press the SETUP button to return to the preceding menu.

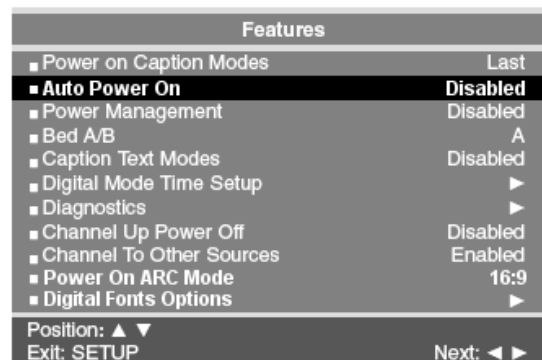

Features

Power Management

The TV will automatically power off after a specific period of viewer inactivity providing energy savings.

1. In Features menu, press the CH▲ / CH▼ button to select Power Management.
2. Press the VOL◀ / VOL▶ button to determine active time. Set to Disabled to disable this feature.
3. Press the SETUP button to return to the preceding menu.

NOTE: Auto Power On must be set to Disabled for this function to operate.

Features	
■ Power on Caption Modes	Last
■ Auto Power On	Disabled
■ Power Management	Disabled
■ Bed A/B	A
■ Caption Text Modes	Disabled
■ Digital Mode Time Setup	▶
■ Diagnostics	▶
■ Channel Up Power Off	Disabled
■ Channel To Other Sources	Enabled
■ Power On ARC Mode	16:9
■ Digital Fonts Options	▶
Position: ▲ ▼	
Exit: SETUP	Next: ◀ ▶

Bed A/B

The TV can be controlled using a patient IR remote control part number PD108-421. This feature setting selects which IR remote control to recognize – bed A remote or bed B remote.

1. In Features menu, press the CH▲ / CH▼ button to select Bed A/B.
2. Press the VOL◀ / VOL▶ button to select remote control A or B.
3. Press the SETUP button to return to the preceding menu.

NOTE: The patient remote's bed codes are set by press a paper clip or pencil tip end into the code hole located above the "CODE" label on the remote.

Features	
■ Power on Caption Modes	Last
■ Auto Power On	Disabled
■ Power Management	Disabled
■ Bed A/B	A
■ Caption Text Modes	Disabled
■ Digital Mode Time Setup	▶
■ Diagnostics	▶
■ Channel Up Power Off	Disabled
■ Channel To Other Sources	Enabled
■ Power On ARC Mode	16:9
■ Digital Fonts Options	▶
Position: ▲ ▼	
Exit: SETUP	Next: ◀ ▶

Caption Text Modes

Teletext can be displayed in addition to Captions. Teletext is not normally broadcast in the USA. Caption Text Modes should be set to Disabled for televisions operated in the USA.

1. In Features menu, press the CH▲ / CH▼ button to select Caption Text Modes.
2. Press the VOL◀ / VOL▶ button to select Disabled or Enabled.
3. Press the SETUP button to return to the preceding menu.

Features	
■ Power on Caption Modes	Last
■ Auto Power On	Disabled
■ Power Management	Disabled
■ Bed A/B	A
■ Caption Text Modes	Disabled
■ Digital Mode Time Setup	▶
■ Diagnostics	▶
■ Channel Up Power Off	Disabled
■ Channel To Other Sources	Enabled
■ Power On ARC Mode	16:9
■ Digital Fonts Options	▶
Position: ▲ ▼	
Exit: SETUP	Next: ◀ ▶

Features

Digital Mode Time Setup

The current time will be set automatically from a digital channel signal provided by a broadcasting TV station.

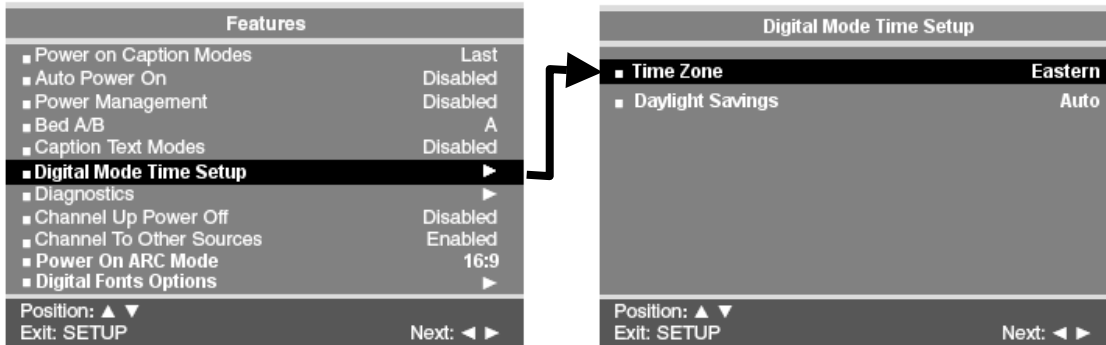

1. In Features menu, press the CH▲ / CH▼ button to select Digital Mode Time Setup.
2. Press the VOL◀ / VOL▶ button to select your viewing area time zone; Pacific, Alaska, Hawaii, Newfoundland, Atlantic, Eastern, Central, Mountain.
3. Press the CH▲ / CH▼ button to select Daylight Saving.
4. Press the VOL◀ / VOL▶ button to select Auto, On, Off depending on whether or not your viewing area observes Daylight Saving time.
5. Press the SETUP button to return to the preceding menu.

Diagnostics

This menu provides readouts of the TV's internal operation. The Diagnostics menu items are read-only and can not be changed.

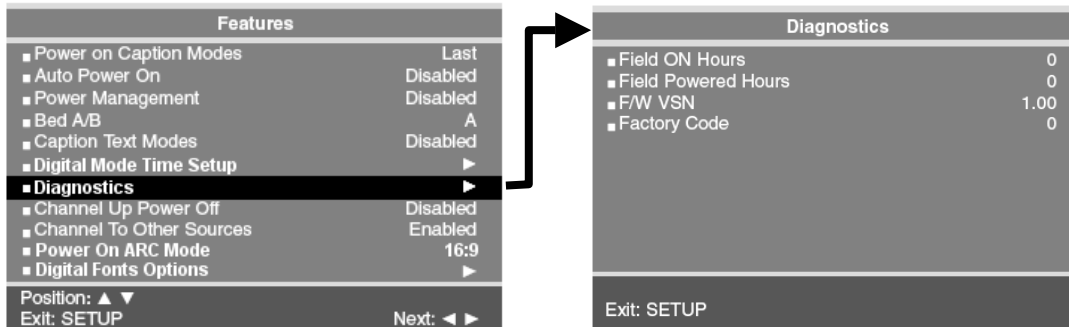

- Field ON Hours:** Cumulative time TV is actually on.
- Field Powered Hours:** Cumulative time TV is powered.
- F/W VSN:** Firmware Version.
- Factory Code:** Use for Factory Diagnostics

Features

Channel Up Power Off

This feature causes the TV to turn off once it reaches the highest numbered (last) channel and is usually used with single button style pillow speakers. When the feature is disabled, the TV will continue on to the lowest channel and not turn off.

1. In Features menu, press the CH▲ / CH▼ button to select Channel Up Power Off.
2. Press the VOL◀ / VOL▶ button to select Enabled or Disabled.
3. Press the SETUP button to return to the preceding menu.

Features	
■ Power on Caption Modes	Last
■ Auto Power On	Disabled
■ Power Management	Disabled
■ Bed A/B	A
■ Caption Text Modes	Disabled
■ Digital Mode Time Setup	▶
■ Diagnostics	▶
■ Channel Up Power Off	Disabled
■ Channel To Other Sources	Enabled
■ Power On ARC Mode	16:9
■ Digital Fonts Options	▶
Position: ▲ ▼	
Exit: SETUP	Next: ◀ ▶

Channel To Other Source

External signal sources connected to the TV such as DVD players or Game Boys are shown in the current channel lineup after the highest channel and then shown on the TV. Set this feature to Disabled to require the activation of the external sources via a key press of the TV's front "TV/AV" button. Set this feature to Enabled to allow channel access to external devices.

1. In Features menu, press the CH▲ / CH▼ button to select Channel To Other Source.
2. Press the VOL◀ / VOL▶ button to select Enabled or Disabled.
3. Press the SETUP button to return to the preceding menu.

Features	
■ Power on Caption Modes	Last
■ Auto Power On	Disabled
■ Power Management	Disabled
■ Bed A/B	A
■ Caption Text Modes	Disabled
■ Digital Mode Time Setup	▶
■ Diagnostics	▶
■ Channel Up Power Off	Disabled
■ Channel to Other Sources	Disabled
■ Power On ARC Mode	16:9
■ Digital Fonts Options	▶
Position: ▲ ▼	
Exit: SETUP	Next: ◀ ▶

Power On ARC Mode

The TV powers on with a set screen sized aspect ratio of 4:3, 14:9, 16:0, 16:9 Panorama, or Last select ARC.

1. In Features menu, press the CH▲ / CH▼ button to select Power On ARC Mode.
2. Press the VOL◀ / VOL▶ button to select 4:3, 14:9, 16:0, 16:9 Panorama, or Last select ARC.
3. Press the SETUP button to return to the preceding menu.

Features	
■ Power on Caption Modes	Last
■ Auto Power On	Disabled
■ Power Management	Disabled
■ Bed A/B	A
■ Caption Text Modes	Disabled
■ Digital Mode Time Setup	▶
■ Diagnostics	▶
■ Channel Up Power Off	Disabled
■ Channel To Other Sources	Enabled
■ Power On ARC Mode	16:9
■ Digital Fonts Options	▶
Position: ▲ ▼	
Exit: SETUP	Next: ◀ ▶

Features

Digital Fonts Options

Customization of Teletext message text is possible. NOTE: Teletext is not utilized in the USA.

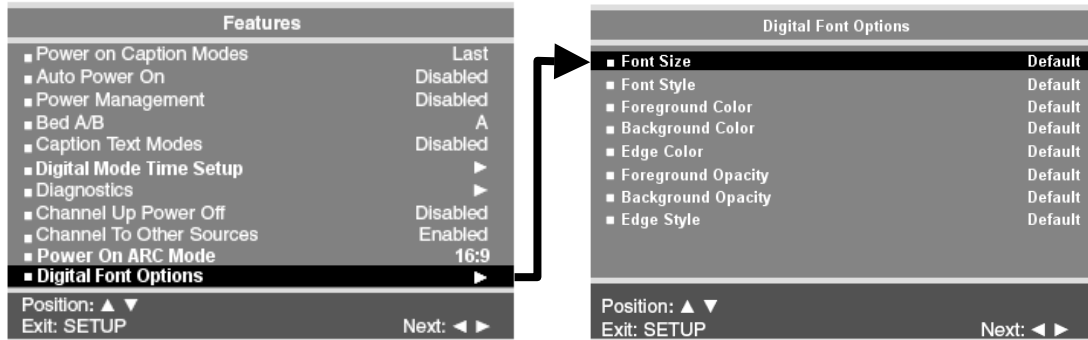

1. In Features menu, press the CH▲ / CH▼ button to select Digital Font Options.
2. Select the desired Font attribute and adjust using the VOL◀ / VOL▶ button.
3. Press the SETUP button to return to the preceding menu.

OSD Language

On Screen Menu Language Selection

You can adjust the language used in displaying the (OSD) on screen display.

1. Press the SETUP button on the remote control.
2. Press the CH▲ / CH▼ button to select the OSD Language menu.
3. Press the ◀▶ button to select your desired language.

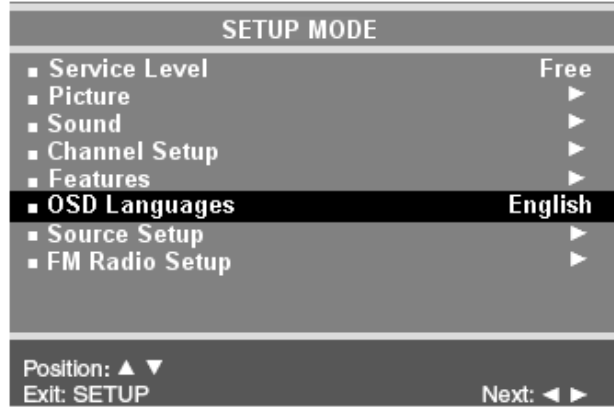

4. Press the SETUP button to exit the main menu.

Source Setup

Changing the Source Input

The TV can be switched to other display modes such as VCR, DVD, PC, or other externally connected devices. The source(s) must be enabled for the input to function.

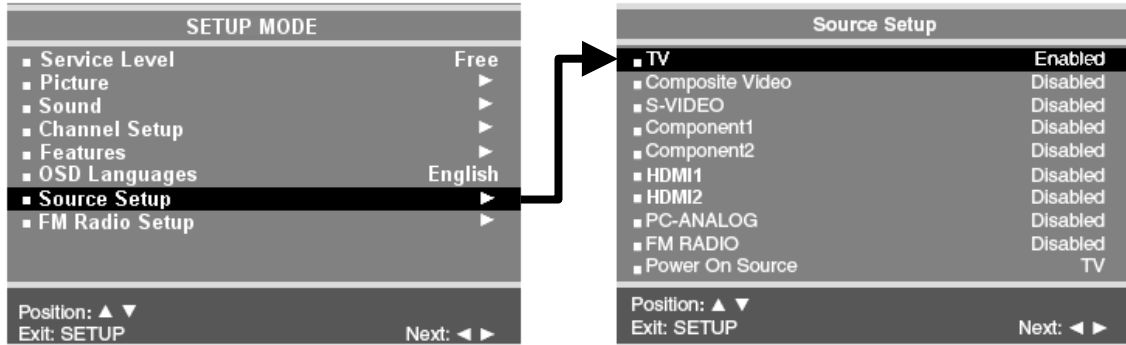

4. Press the SETUP button on the remote control.
5. Press the CH▲ / CH▼ button to select the Source Setup menu and Volume to activate.
6. Press the ◀▶ button to select your desired language.
7. Press the TV/AV button to change to another source input.

NOTE: The desired source input must be enabled in the Source Setup menu. Please see "Source Setup" instructions elsewhere in this manual for details.

8. Alternatively, press CH▲ / CH▼ buttons until reaching the highest channel (or below to the lowest channel). All activated sources will appear in the channel table above the highest channel and is directly viewable.

NOTE: The "Channel to Other Sources" must be enabled in the FEATURES menu to allow top of channel display of activated sources.

FM Radio

FM Radio Setup

You can listen to FM radio stations that are combined with the cable TV signals using this TV.



IMPORTANT: The FM radio source must be enabled in the SOURCE SETUP menu before using the FM Radio setup menu.

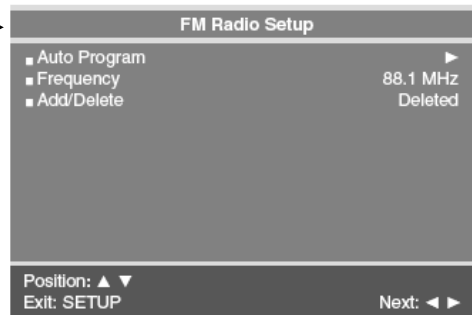
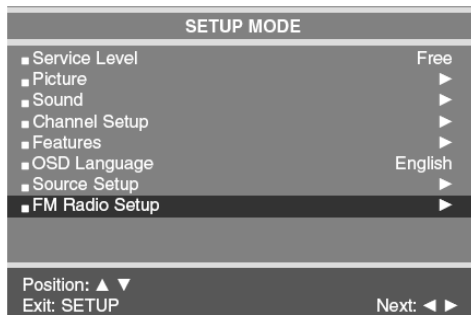

Auto Program

1. Press the SETUP button.
2. Press the CH▲ / CH▼ button to select the FM Radio Setup menu. Then press the VOL◀ / VOL▶ buttons to enter the menu.
3. Press the VOL◀ / VOL▶ button to automatically scan.
4. Press the CH▲ / CH▼ button to Confirm FM Radio Auto Program. (CH▲=Yes, CH▼=No). The TV will now search all available radio channels looking for signals and memorizing those radio channels that are active.
5. Press the SETUP button to return to FM Radio Setup menu.

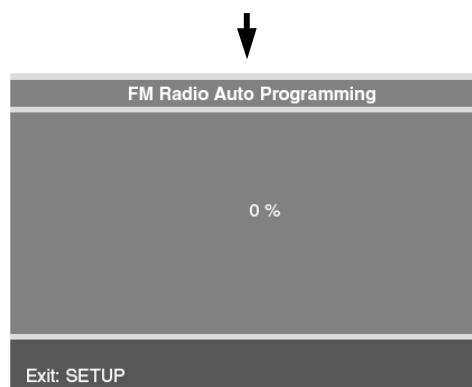
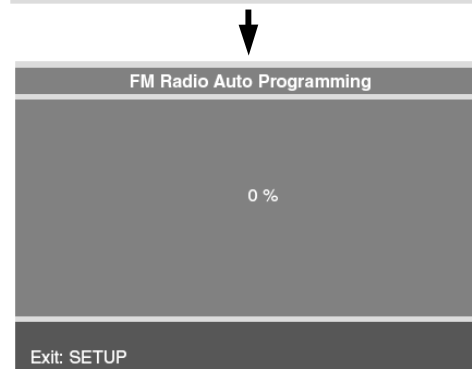

Add/Delete Stations

1. Select the Frequency you wish to Add or Delete.
2. To delete a frequency from memory, press the CH▲ / CH▼ button to select Add/Delete.
3. Select off with the VOL◀ / VOL▶ to Add or Delete the frequency.
4. Press the Setup button to return to the FM Radio Setup menu.

Specifications*

Model	PDI-P22LCDC		
Television system	DTV-ATSC (VSB, Clear QAM) / TV-NTSC		
Television program	Air VHF: 2~69 Cable Std 2~125 Cable HRC/IRC 1~125(NTSC) Air VHF: 2~69 Cable Std 2~134 Cable HRC/IRC 1~134(ATSC/QAM)		
LCD Panel	22" Diagonal TFT LCD		
Panel Resolution	WXGA(1366 x 768)		
Power consumption	80 W		
External antenna impedance	75Ω		
Audio output	2 @ 10-watt RMS		
External IN/OUT ports	RF IN PILLOW SPEAKER SERVICE PORT CCI MTI	COMPONENT 1 COMPONENT 2 S-VIDEO S-VIDEO AUDIO COMPOSITE VIDEO	HDMI 1 HDMI 2 PC RGB DVI
AC Power	100V~240V, 50/60 HZ, 80W MAX		
Dimension	21.25" (W) x 16.5" (H) x 3.8" (D)		
Weight	15 lbs, 6.8 Kg		

* All rights reserved for technical modifications.

Troubleshooting

PROBLEM	CHECK
No Picture on Screen, No Sound from Speakers	<ul style="list-style-type: none"> • Make sure the TV set is powered – Power indicator is Red. • Turn on the TV using the “ON/OFF” power button.
No Picture, Sound OK	<ul style="list-style-type: none"> • Check the Brightness setting of the TV. • Internal LCD panel lamps may have failed. • If a secondary source is selected, verify the Video input signal is connected.
Picture OK, No Sound	<ul style="list-style-type: none"> • Check the Volume settings. • Verify the Sound has not been muted. • Verify the pillow speaker is connected with the pillow speaker volume wheel adjusted for proper sound. • If a secondary source is selected, verify the audio input signal is connected.
No Sound from Internal TV Speakers	<ul style="list-style-type: none"> • Verify TV speaker has not been disabled in the “Internal Speaker Disable” setup menu. • Verify the Sound has not been muted.
Picture is too Light	<ul style="list-style-type: none"> • Verify correct color and contrast settings.
Picture is too Dark	<ul style="list-style-type: none"> • Verify Brightness setting correct and not too low. • Internal LCD Panel lamps may have failed.
Remote Control does not work	<ul style="list-style-type: none"> • Change the remote’s batteries. • Verify the TV’s IR window is not flooded with strong lights such as from fluorescent lamps. • For a Patient Remote, verify correct Bed Code settings.
Picture is not sharp. Picture moves or jitters.	<ul style="list-style-type: none"> • The cable TV signal may be weak. • Verify the coax cable is connected.
Picture has ghost images	<ul style="list-style-type: none"> • The cable TV signal may be weak. • The coax cable connection may be loose.
Stripes or Dots move through picture	<ul style="list-style-type: none"> • Possible interference from nearby hospital equipment. • The cable TV signal may be weak.

Limited Warranty

NOTE: Opening the TV set, or attempting a repair by non-PDI personnel will void the Warranty!

PDI Communication Systems Inc., ("PDI") warrants, to the original purchaser only, that this television will be free from defects in materials and workmanship, under normal use, for 2 years from the date of original purchase. This warranty does not cover any other equipment that may have been included with PDI's shipment of this product.

After receipt of written notice of a defect or malfunction occurring during the warranty period, PDI will repair or replace goods returned to its Springboro, Ohio location, at its discretion, free of charge to the original purchaser, the whole or any component part of any product manufactured by PDI and found by PDI to be defective.

As a condition to obtaining warranty service, written notification must be received by PDI within at least ten (10) days after defect is first observed. Repair of said product requires it to be shipped to the PDI factory in Springboro, Ohio. All shipments shall be F.O.B. Springboro, Ohio, and all shipping and freight charges to PDI's factory shall be paid by the customer.

This warranty shall not apply to any PDI products subjected to improper use, negligence or accident; nor to tampering, alterations, or repairs by others, without PDI's specific prior written authorization. For information regarding authorized servicing and all other information pertaining to this warranty, please contact PDI COMMUNICATION SYSTEMS at 40 Greenwood Lane, Springboro, Ohio 45066 or phone 937-743-6010.

This warranty gives specific legal rights and you may also have other rights which vary from state to state.

PDI's liability under this warranty is limited to repair or replacement of defective products and parts as provided above. PDI shall not be liable for incidental or consequential damages.*

The warranty contained herein is in lieu of all other expressed or implied warranties, including any implied warranty of merchantability or fitness for any particular purpose. PDI neither assumes nor authorizes any person to assume, on its behalf, any other obligation or liability.

*Some states do not allow the exclusion of limitation of incidental or consequential damages or a disclaimer of warranties implied by law, so the above limitation or exclusion may not apply.

BLANK PAGE



***PDI Communication Systems, Inc.
40 Greenwood Lane
Springboro, Ohio 45066***

PH: 937-743-6010 FX: 937-743-5664

WEB: PDIARM.COM