

Installation and Operating Instructions



P26,32,40 Hospital Grade TVs

**Models: PDI-P26LCDC
PDI-P32LCDD
PDI-P40LCDC**

PDi[®]

Communication
Systems, Inc.

40 Greenwood Lane
Springboro, Ohio 45066

PH: 937-743-6010

FX: 937-743-5664

<http://www.pdiarm.com>

Better Solutions Are Within Reach®

WARNINGS

To reduce the risk of electric shock, DO NOT perform any servicing other than what is contained in the operating instructions, unless you are qualified to do so.



This symbol is intended to alert the user of the presence of un-insulated 'dangerous voltage' within the product's enclosure that may be of sufficient magnitude to constitute a risk of electric shock to persons.



This symbol is intended to alert the user of the presence of important operating and maintenance (servicing) instructions in the literature accompanying the appliance.

NOTE TO CABLE TV INSTALLER

This reminder is provided to call the cable TV systems installer's attention to Article 820-40 of the National Electrical Code. The code provides guidelines for proper grounding and, in particular, specifies that the cable ground shall be connected to the grounding system of the building, as close to the point of the cable entry as practical.

SAFETY INSTRUCTIONS

INSTRUCTIONS

Be sure to read, follow, and keep these instructions. Heed all the warnings.

MAINTENANCE AND SERVICING

Servicing is required when the TV has been damaged in any way, such as the power-supply cord or plug is damaged, liquid has been spilled or objects have fallen into the TV, the TV has been exposed to rain or moisture, does not operate normally, or has been dropped.

Never remove the back cover of the TV; this can expose you to high voltage and other hazards. If the TV does not operate properly, unplug it and call an authorized service center or PDI.



CAUTION: These servicing instructions are for use by qualified service personnel only.

POWER CORD

Protect the power cord from being walked on or pinched particularly at the plugs, convenience receptacles, and the point where they exit from the apparatus.

To avoid any malfunctions of the unit and unwanted electric shock or fire accidents, please observe the following:

- Hold the plug firmly when connecting or disconnecting the AC power cord to/from an outlet.
- DO NOT connect or disconnect the AC power cord when your hands are wet.
- Keep the AC power cord away from heating appliances.
- Never put any heavy objects on the AC power cord.
- DO NOT attempt to repair or reconstruct the AC power cord in any way under any circumstance.
- Remove dust, dirt, etc. from the plug periodically.
- If the unit has been dropped or otherwise damaged, turn off the power and disconnect the AC power cord from the outlet.
- If smoke, odors or noises are emitting from the unit, disconnect the AC power cord immediately.

PLACEMENT

Avoid placing the unit in surroundings with:

- Direct sunlight or heat sources, like radiators or ovens.
- High temperature (over 40 C) or high humidity (over 90%).
- Excessive dust.
- Electro-static effect.
- Vibration, impact, or tilted surface.

Otherwise the internal parts may be damaged.

NON-USE PERIODS

- Turn off the power when the unit is not used.
- It should be unplugged from the AC outlet when the unit is idle for a long period of time.

DVD PLAYER

- Because of high voltage inside the unit, touching internal parts is dangerous and may lead to serious damage to the unit and even personal injury.
- DO NOT attempt to disassemble this unit under any circumstance.
- Only put a DVD or CD into the slot.

STACKING

Place the unit in a horizontal place, and DO NOT lay anything heavy on it.

CONDENSATION

Moisture may condense on the lens if placed in a steamy or very humid room or if moved from a cold environment to a warm one. If moisture appears inside this unit, it may not operate normally. In this case, unplug the power cord and wait for about 1 hour to let it dry.



CAUTION: DO NOT defeat the safety of the polarized or grounding-type plug. A polarized plug has two blades with one wider than the other. A grounding type plug has two plates and a third grounding prong. The wide blade or the third prong is provided for your safety. If the plug does not fit into your outlet, consult an electrician.

RAIN AND MOISTURE

WARNING: To avoid the hazards of fire or electrical shock, DO NOT expose this TV to rain or moisture.

INSTALLATION

DO NOT block any ventilation openings. DO NOT install near any heat source such as radiators, heat registers, stoves, or other apparatus that produce heat.

WET LOCATION

The TV SHOULD NOT be exposed to dripping or splashing. Objects filled with liquids, such as vases, SHOULD NOT be placed on the TV.

OXYGEN ENVIRONMENT

WARNING: DO NOT use in an oxygen tent or an oxygen chamber. Such use may cause a fire hazard.

CLEANING AND DISINFECTION

Clean the exterior of this TV by removing dust with a lint-free cloth.



CAUTION: DO NOT use abrasive or chemical cleaning agents. Clean only with a dry cloth.

PRODUCT MODIFICATION

DO NOT attempt to modify this product in any way without written authorization. Unauthorized modification could void the user's authority to operate this product.

OVERHEAD FALLING HAZARD

WARNING: To prevent injury, this apparatus must be securely attached to the wall in accordance with the installation instructions. TVs can pose a striking hazard when mounted at an elevated position.

OTHER EQUIPMENT

Use only with the cart, stand, tripod, bracket or table specified by the manufacturer or sold with the TV. Use caution when moving the cart.



WARNING: To reduce the chance of fire or electric shock, only use the accessories recommended by the manufacturer.

FCC, Copyright, Disclaimer, and Trademarks

FCC

This equipment has been tested and found to comply with the limits for a Class B digital device, pursuant to part 15 of the FCC Rules. These limits are designed to provide reasonable protection against harmful interference when the equipment is operated in a residential or commercial installation. If this equipment does cause harmful interference to radio or TV reception, which can be determined by turning the equipment off and on, the user is encouraged to try to correct the interference by one of more of the following measures:

- Reorient or relocate the receiving antenna.
- Increase the separation between the equipment and receiver.
- Connect the equipment into an outlet on a circuit different from that to which the receiver is connected.
- Consult the dealer or an experienced radio/TV technician for help.

Copyright

PDI Communication Systems, Inc. claims proprietary right to the material disclosed in this user manual. This manual is issued for user information only and may not be used to manufacture anything shown herein. Copyright 2009 by PDI Communication Systems, Inc. All rights reserved.

Disclaimer

The author and publisher have used their best efforts in preparing this manual. PDI Communication Systems, Inc. makes no representation or warranties with respect to the accuracy or completeness of the contents of this manual and specifically disclaim any implied warranties or merchantability or fitness for any particular purpose and shall in no event be liable for any loss of profit or any other damages. The information contained herein is believed to be accurate, but is not warranted, and is subject to change without notice or obligation.

Trademarks

Manufactured under license from Dolby Laboratories. Dolby and the double-D symbol are trademarks of Dolby Laboratories. All other brand names and product names used in this manual are trademarks, registered trademarks, or trade names of their respective holders. PDI and Better Solutions Are Within Reach are registered trademarks of PDI Communication Systems, Inc., Springboro, Ohio.

Location Guidelines

The model PDI-P26/P32/P40LCD Hospital Grade LCD TV is a specialized LCD TV. It is intended for entertainment and educational purposes in a hospital, a nursing home, medical-care center, or similar health-care facility in which installation is limited to a non-hazardous area in accordance with the National Electrical Code, ANSI/NFPA 70. The PDI-P26/P32/P40LCD is designed for mounting to PDI manufactured mounts. Installation of the TV on any other mount is not recommended.



WARNING: The TV's VESA mounting holes are designed for M4 and/or M6 metric screws only. Use of a non-PDI approved mount or SAE hardware could result in a condition where the TV could unexpectedly fall and cause injury or death.

The PDI-P26/P32/P40LCD TV mounts on the wall at the foot of a patient's bed. Select a location that is near an AC wall outlet and that does not expose the TV to bright room lights or sunlight, if possible. The LCD TV also requires connection of both CATV cable signal and across-room wiring for the pillow speaker.

OSHPD (State of California Only)

The combined weight of the PDI-P26/P32/P40LCD TV and PDI wall mount is less than 20 pounds. At the time of this writing, the involvement of a written, submitted, reviewed, and approved plan by OSHPD is not required to install the PDI-P26/P32/P40LCD TV in the state of California.

Table of Contents

Warnings	2
Safety Instructions.....	2
FCC	4
Copyright.....	4
Disclaimer	4
Trademarks.....	4
Location Guidelines.....	4
OSHPD (State of California Only).....	4
Standard Wall Bracket for PDI-P26LCD TV	7
Mounting Connections.....	7
Wall Mounting for PDI-P32LCD TV and PDI-P40LCD TV	8
Mounting Connections.....	8
Connections.....	9
Pillow Speakers.....	10
Across-Room Wiring.....	10
Product Accessories.....	11
Remote Controls.....	11
Battery Installation.....	11
Programming Remote Control.....	12
Patient Remote Control.....	13
Side-Panel buttons.....	14
Front Panel	15
Programming.....	16
Service Levels.....	17
Picture.....	18
Brightness, Contrast, Color, Tint, and Sharpness.....	18
Color Temperature	19
PC Analog/HDMI Picture.....	19
Component Input Picture	20
Sound.....	20
Balance.....	20
Minimum Volume.....	21
Maximum Volume	21
Power on Volume	21
Internal Speaker Enabled	22
HDMI 1 and 2 Audio Port.....	22
Channels	23
Signal	23
Auto Program.....	24
Add/Delete Channels	25
Clear Service Level.....	26
Copy Service Level.....	27
Parental Control	27
TV Rating.....	28
TV Parental Guideline Rating System	28
The sub-rating of TV rating.....	29
MPAA Rating.....	29
Motion Picture Association of USA (MPAA) Rating System	30
Change Password	30
Aux. Block Source	30
Block Hour	30
Parental Lock.....	31
Power on Channel.....	31
Channel Lock	31
Channel Memory Override	31
Features.....	32
Power on Caption Mode	32
Auto Power on/lock	32

Inactive Power Off (h:mm)	33
Bed A/B	33
Caption Text Modes.....	33
Digital Captions	34
Digital Mode Time Setup.....	35
Diagnostics.....	36
Channel up Power Off	36
Channel to Other Source	36
Power on ARC Mode.....	37
On Screen Menu Language Selection.....	37
Sources.....	37
Power on Source	37
FM Radio	38
Auto Program.....	38
Add/Delete Stations	38
Cloning.....	39
Save Settings to SD Card.....	39
Restore Setting to TV	40
Information	41
Firmware.....	42
DVD Module.....	43
Install DVD Module	44
Enable DVD Module	45
Insert DVD	45
Basic DVD functions.....	46
Navigating menus	46
Advanced DVD playback features.....	46
Repeating a Chapter or Title	46
Changing the Subtitle and Audio	46
DVD Content Information	47
CD Playback.....	47
Inserting disc.....	47
Basic controls.....	48
Advanced CD playback features.....	48
Setting a track or whole CD to loop.....	48
Skipping to a certain place on a CD.....	48
Adjusting Audio output.....	49
Viewing JPG photos on a USB drive, Media card, or data CD	49
USB port and card reader.....	49
Access USB/SD Card.....	49
Access Photo CD	49
View JPEG.....	49
Control Slide Show	49
Selecting Thumbnail Photos	50
Selecting More Thumbnails.....	50
Other Thumbnail Screen Controls	50
Setup menu.....	50
Warranty.....	52

Standard Wall Bracket for PDI-P26LCD TV

The PDI-P26LCD TV is mounted to the wall with a PD168-003 mount (**Not supplied with TV**) or a PD168-203 mount (**Not supplied with TV**). The PD168-203 mount is a heavy duty mount and is to be used if a DVD or an IPT module is going to be mounted on the P26. A PD168-203 wall mount connects to a PD181-674 LCD mount. A PD168-003 wall mount connects to a PD181-597 LCD mount.

Mounting Pieces		
Wall Mount	LCD Mount	Purpose
PD168-003	PD181-597	For mounting PDI-P26LCD TV to wall without DVD and/or IPT Modules (1)
PD168-203	PD181-674	For mounting PDI-P26LCD TV to wall with DVD and/or IPT Modules (1)
Screws		
Part #	Part	
PDIPPBHSCS103250	10-32 X ½ Pilfer Proof PIH Button Head (2)	
PDIPPHMSM4X76	M4-.7 X 6MM PPHMS (4)	
Numbers in parenthesis represent quantity		

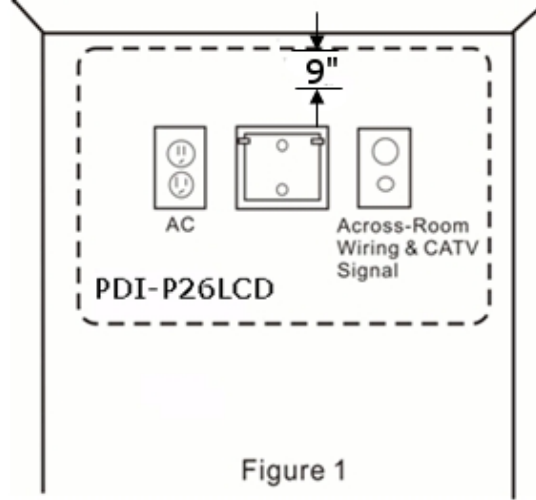

1. Refer to Figure 1. Select a location on the wall approximately 9 inches below the ceiling.

NOTE: DO NOT locate AC, Across-Room Wiring, and CATV Signal outlets below the Wall Bracket's location as it will cause clearance issues and interfere with the TV's cabinet when mounted to the bracket.

2. Position the wall mount and locate the two mounting holes. Secure the bracket to the wall (mounting hardware is not included).

3. Refer to Figure 2. Position the LCD mount on the LCD TV cabinet.

Attach with the four M4 screws (PDIPPHMSM4X76) that are provided.

NOTE: Earlier model of P26 used M6 screws.

4. Mate the LCD mount to the wall mount, making sure the pivot pins are retained in the slots.

5. Secure with two 10x32 Pilfer screws (PDIPPBHSCS103250).

6. The TV's tilt can be adjusted by loosening both Pilfer screws, adjusting tilt, and then tightening the screws.

Mounting Connections

Figure 2

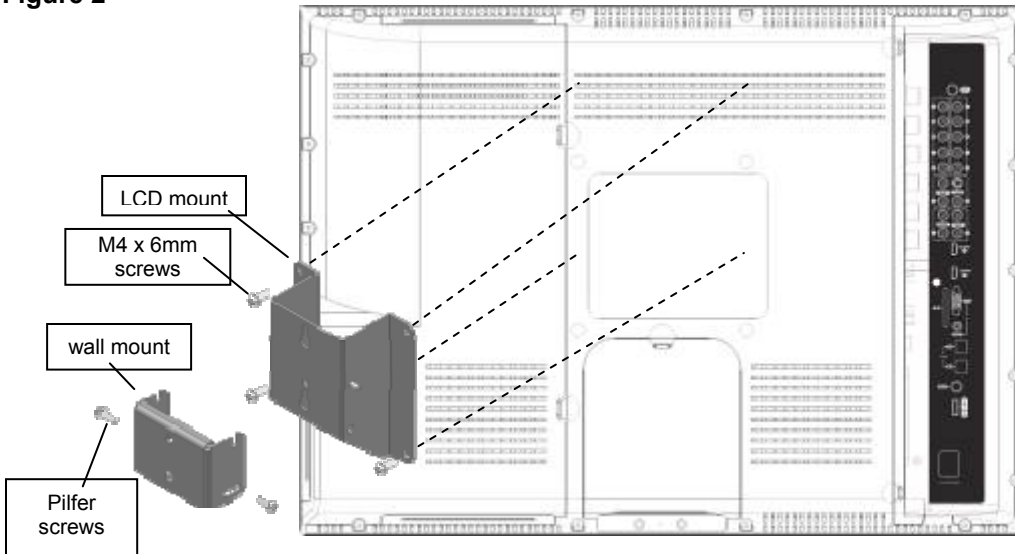

Wall Mounting for PDI-P32LCD TV and PDI-P40LCD TV

The PDI-P32LCD and PDI-P40LCD TVs require a PD181-672 200mm to 100mm Adapter Plate (**Not supplied with TV**), a PD181-596 LCD Mounting Bracket (**Not supplied with TV**), and a PD181-674 HD Extended LCD Tilt Clevis (**Not supplied with TV**) to be mounted to the wall.

1. Refer to **Figure 1**. For the PDI-P32LCD find a location on the wall 10.5 inches below the ceiling to mount the HD Extended LCD Tilt Clevis (wall mount). For the PDI-P40LCD, the location will be 10 inches below the ceiling.

NOTE: DO NOT locate AC, Across-Room Wiring, and CATV Signal outlets below the Wall Bracket's location as it will cause clearance issues and interfere with the TV's cabinet when mounted to the bracket.

2. Position the HD Extended LCD Tilt Clevis and locate the two mounting holes. Place one of the supplied 1/4" flat washers (PDIFW25) and the 1/4" lock washer (PDISLW25) on a 1/4" screw (not included) and insert it into the top mounting hole of the clevis. Secure the clevis to the wall. Place the other supplied 1/4" flat washer on another 1/4" screw and insert it in the bottom mounting hole. Secure it to the wall and tighten both screws.
3. Refer to **Figure 2**. Attach the LCD mount to adapter plate using the four M4 screws (PDIPPHMSM4X76) and four #10 Internal Tooth Lock washers (PDIITLW10).

NOTE: The side with the four hex sides will go toward the back of the set.

4. Position the mounting bracket and adapter plate on the LCD TV cabinet. Attach with the four M6 screws (PDIPPHMSM6X110) that are provided.

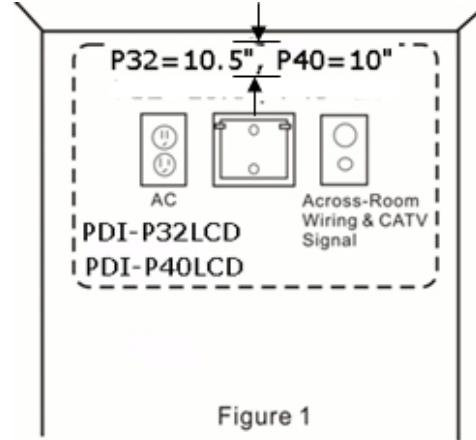
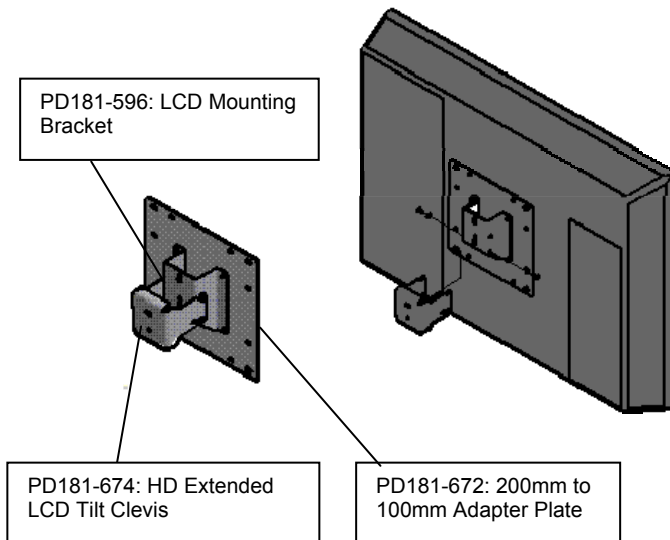

Figure 1

5. Mate the mounting bracket to the clevis making sure the resting pins are inserted in the two notches at the front of the clevis. Secure with the two 10x32 screws (PDIPPHMS103238) and the two remaining Internal Tooth Lock washers.
6. The TV's tilt can be adjusted by loosening both Pilfer Screws, adjusting tilt, and then tightening the screws.

Mounting Connections

Figure 2



Mounting Pieces	
Part #	Part
PD181-672	200mm to 100mm Adapter Plate (1)
PD181-596	LCD Mounting Bracket (1)
PD181-674	HD Extended LCD Tilt Clevis (1)
Screws and Washers	
PDIPPHMS103238	10-32X3/8 PPHMS (2)
PDIITLW10	#10 Internal Tooth Lock Washer (6)
PDIPPHMSM4X76	M4-.7X6mm PPHMS (4)
PDIPPHMSM6X110	M6-1X10mm PPHMS (4)
PDIFW25	1/4" flat washer (2)
PDISLW25	1/4" lock washer (1)
Numbers in parenthesis represent quantity	

Connections

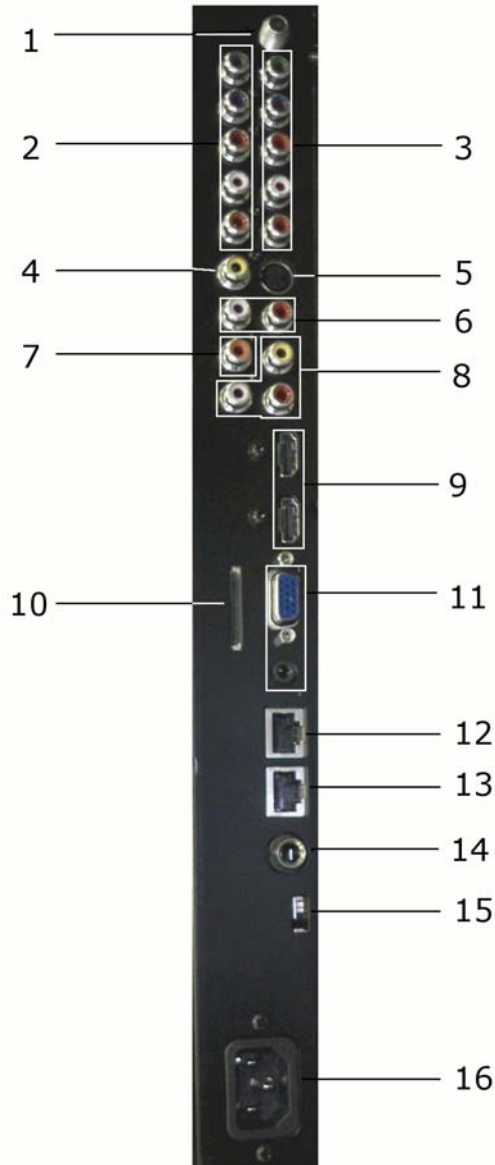

1. COAXIAL OUT
2. Component 1
3. Component 2
4. Composite Video
5. S-Video
6. L and R audio input for S-Video or Composite Video
7. SPDIF
8. Composite Out
9. HDMI 1 and 2
10. SD Card slot for cloning
11. VGA and VGA audio input
12. MTI
13. CCI
14. Pillow speaker connector
15. Pillow speaker switch
16. AC power cord connection

Pillow speaker

A 1/4" stereo-style pillow speaker (pendant control) jack is located on the TV's connector panel on the backside. This TV is designed to work with either a digital pillow speaker that generates digital-style control codes or a single-button analog (switch-style) pillow speaker. A rear panel mounted switch allows use of different brands of pillow speakers and supports the major brands: Zenith®, Philips®, and RCA®.



CAUTION: Confirm the pillow speaker type and set the side switch appropriately BEFORE connecting the pillow speaker to the TV. Failure to follow this procedure could result in damage to the pillow speaker or cause improper operation of the TV.

Across-Room Wiring

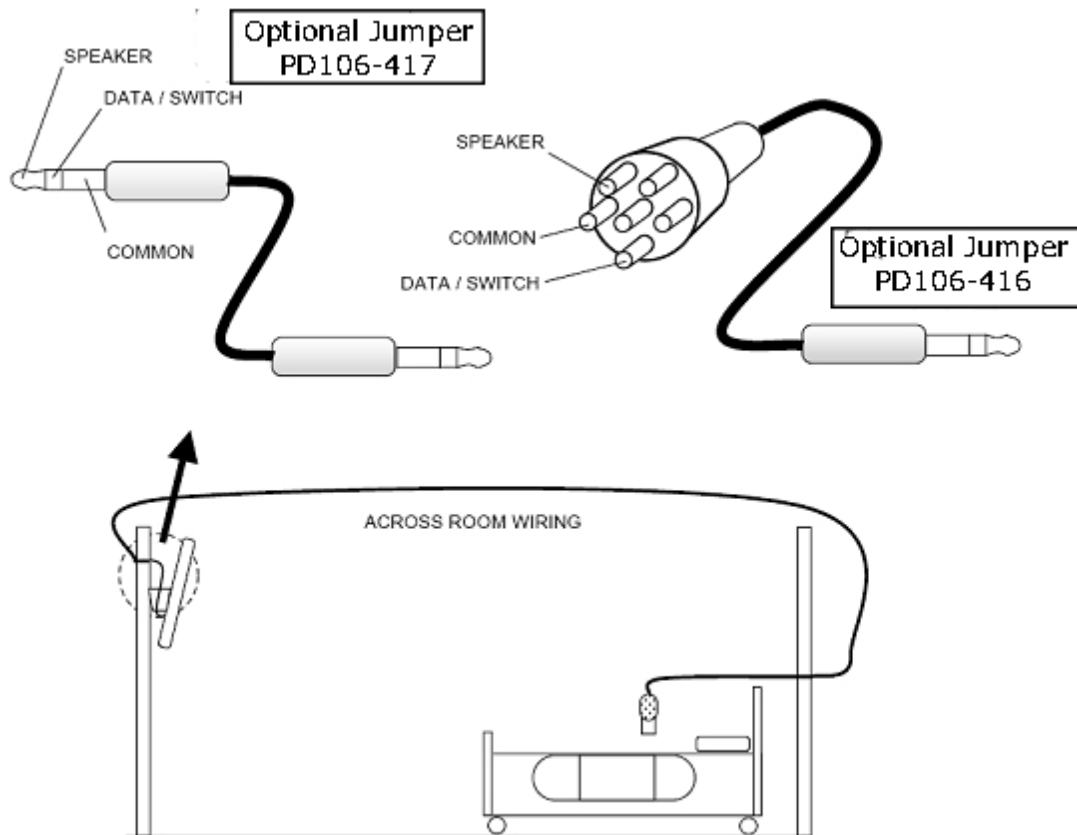

Product Accessories

(Not Included with TV)

Programming Remote Control	PD108-420	¼" to 6-Pin Jumper Cable	PD106-416
Patient Remote Control (*Remote comes with DVD module)	PD108-427	¼" to ¼" Jumper Cable	PD106-417
Patient Remote Control (*For TV's without DVD module)	PD108-421		

Remote Controls

Operating and programming a P26, P32, or P40 and a compatible DVD and IPT Modules (both sold separately) requires a remote control. There are two remotes that are designed to work with the TVs, a programming remote and patient remote. Descriptions for them start on page 12.

NOTE: Make sure batteries are installed

Battery Installation

Before using either remote, make sure the batteries are installed.

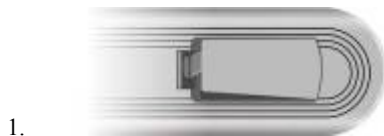

Softly push the back cover to open the battery compartment.



Replace the battery compartment cover.



Insert two batteries (1.5V, size AAA), ensuring the polarity matches the marks inside the compartment.

NOTE:

- Install two high-quality 1.5V "AAA" alkaline batteries. Don't mix old batteries with new batteries.
- Remove batteries when you won't use the remote controller for long time. Liquid leakage from old batteries may cause operation failure.

Programming Remote Control

The programming remote, PD108-420, is used to change the settings in the menus on the TVs. The settings in the menus are how the TVs are programmed. Power, SETUP, and the directional buttons will be the main buttons used on this remote.



1. **POWER button**
Turns the TV on or off.
2. **MUTE button**
Turns the sound on or off.
3. **SETUP button**
Access programming menus.
4. **TV/AV button**
Selects enabled external inputs or TV.
5. **CH LIST button**
Display list of channels programmed into TV.
6. **TV/FM button**
Switch between TV and FM Radio sources.
7. **SLEEP button**
Sets the sleep timer.
8. **LAST button**
Return to previously viewed channel.
9. **VOL ◀▶ buttons**
Raises or lowers volume. Also used to navigate programming menus.
10. **OK button**
Confirms the current channel selection.
11. **CH ▲▼ buttons**
Selects next channel. Also used to navigate programming menus.
12. **ARC button**
Changes the aspect ratio. Repeatedly press the ARC button to select your desired picture format. (See page 41 for instructions on adjusting picture up or down.)
13. **CC button**
Cycles through Closed caption choices.
14. **PSM button**
Adjust sound setting for content type: User, Standard, Dynamic, Mild, or Game.
15. **SAP button**
Adjust audio mode: MTS-Stereo, Mono, or SAP
16. **SSM button**
Adjust sound setting for content type: User, Flat, Speech, Movie, or Music.
17. **Number buttons**
Use to directly enter channels. 0-9
18. **DASH button**
Use to enter second part of a digital channel.
19. **Teletext buttons**
Navigates teletext displays. Teletext is not actively used in the USA.

Patient Remote Control - PD108-427

The patient remote, PD108-427, is used for controlling the TV and the compatible DVD and IPTV Modules.

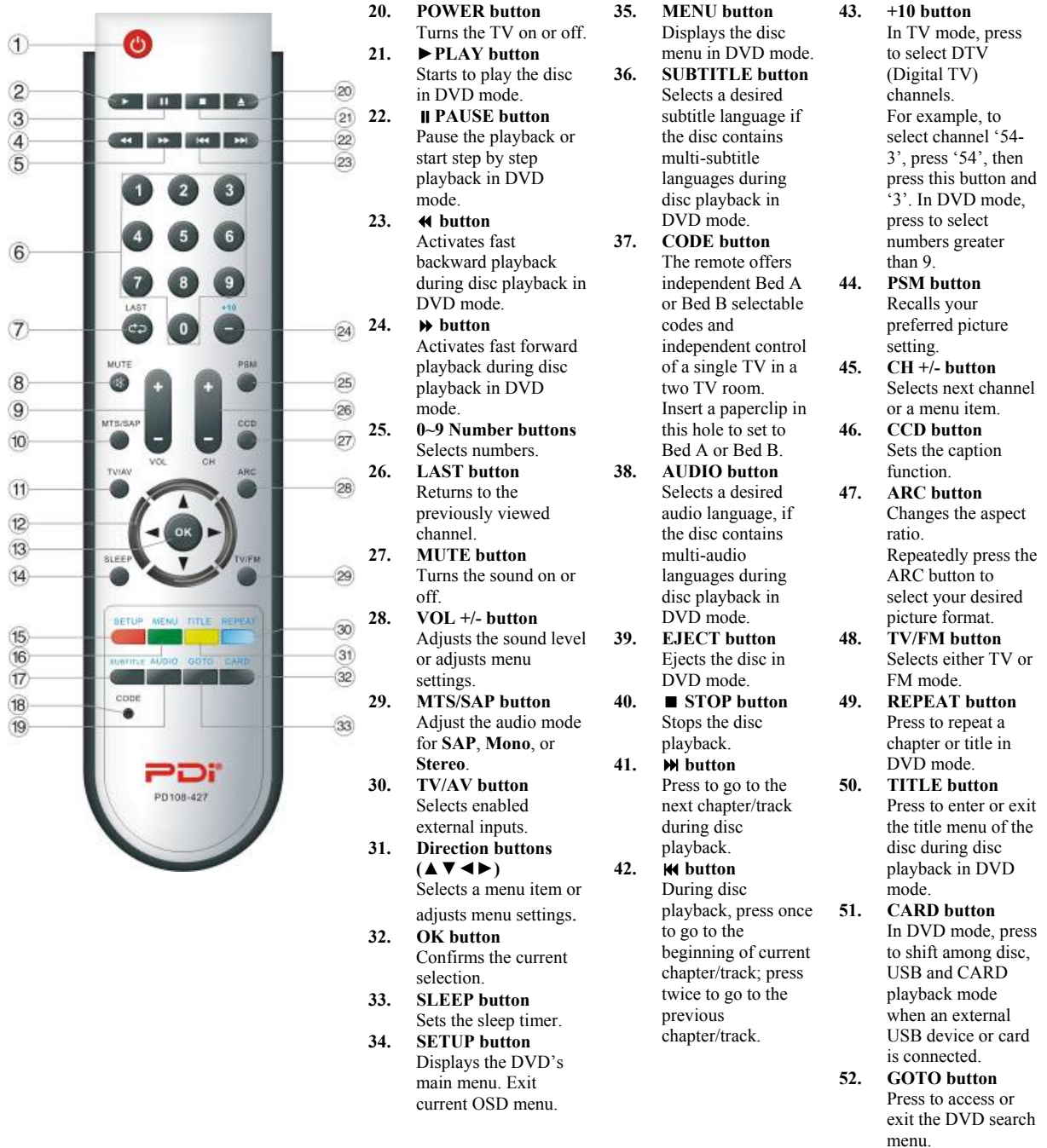

- 20. **POWER button**
Turns the TV on or off.
- 21. **▶ PLAY button**
Starts to playback the disc in DVD mode.
- 22. **⏸ PAUSE button**
Pause the playback or start step by step playback in DVD mode.
- 23. **◀ button**
Activates fast backward playback during disc playback in DVD mode.
- 24. **▶ button**
Activates fast forward playback during disc playback in DVD mode.
- 25. **0-9 Number buttons**
Selects numbers.
- 26. **LAST button**
Returns to the previously viewed channel.
- 27. **MUTE button**
Turns the sound on or off.
- 28. **VOL +/- button**
Adjusts the sound level or adjusts menu settings.
- 29. **MTS/SAP button**
Adjust the audio mode for SAP, Mono, or Stereo.
- 30. **TV/AV button**
Selects enabled external inputs.
- 31. **Direction buttons (▲▼◀▶)**
Selects a menu item or adjusts menu settings.
- 32. **OK button**
Confirms the current selection.
- 33. **SLEEP button**
Sets the sleep timer.
- 34. **SETUP button**
Displays the DVD's main menu. Exit current OSD menu.
- 35. **MENU button**
Displays the disc menu in DVD mode.
- 36. **SUBTITLE button**
Selects a desired subtitle language if the disc contains multi-subtitle languages during disc playback in DVD mode.
- 37. **CODE button**
The remote offers independent Bed A or Bed B selectable codes and independent control of a single TV in a two TV room. Insert a paperclip in this hole to set to Bed A or Bed B.
- 38. **AUDIO button**
Selects a desired audio language, if the disc contains multi-audio languages during disc playback in DVD mode.
- 39. **EJECT button**
Ejects the disc in DVD mode.
- 40. **■ STOP button**
Stops the disc playback.
- 41. **▶▶ button**
Press to go to the next chapter/track during disc playback.
- 42. **◀◀ button**
During disc playback, press once to go to the beginning of current chapter/track; press twice to go to the previous chapter/track.
- 43. **+10 button**
In TV mode, press to select DTV (Digital TV) channels. For example, to select channel '54-3', press '54', then press this button and '3'. In DVD mode, press to select numbers greater than 9.
- 44. **PSM button**
Recalls your preferred picture setting.
- 45. **CH +/- button**
Selects next channel or a menu item.
- 46. **CCD button**
Sets the caption function.
- 47. **ARC button**
Changes the aspect ratio. Repeatedly press the ARC button to select your desired picture format.
- 48. **TV/FM button**
Selects either TV or FM mode.
- 49. **REPEAT button**
Press to repeat a chapter or title in DVD mode.
- 50. **TITLE button**
Press to enter or exit the title menu of the disc during disc playback in DVD mode.
- 51. **CARD button**
In DVD mode, press to shift among disc, USB and CARD playback mode when an external USB device or card is connected.
- 52. **GOTO button**
Press to access or exit the DVD search menu.

Side-Panel buttons

The buttons on the right side of the TV can be used to control a limited number of the television's basic operating functions.

NOTE: PDI patient remote control PD108-427 can be used to operate all of the television's functions. A programming remote, PD108-420, is used to set up the TV for use in a medical facility. (See remote control section on the previous page).



TV/AV

Press this button to cycle through all enabled sources.

CC

Closed Caption. Press this button to cycle through all the closed caption settings.

CH▲

Press this button to go to the next channel

CH▼

Press this button to go to the previous channel

VOL▲

Press this button to increase the volume

VOL▼

Press this button to decrease the volume

■STOP

When the DVD Module is installed and operating, press this button to stop a disc that is playing.

►PLAY

When the DVD Module is installed and operating, press this button to start playing a disc.

▲EJECT

Press this button to remove a disc from the DVD Module.

⏻POWER

Press this button to turn the TV on and off.

Front Panel

Red – OFF (Power Connected, TV is off)

BLUE – ON

Dark – OFF (Power Disconnected)

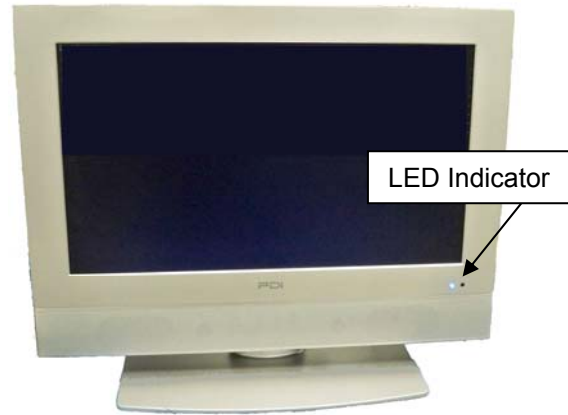

Programming

The PDI-P26/P32/P40LCD TV is programmed by a series of menus that can be accessed with a programming remote, part number PD108-420. Access the menus by pressing **SETUP** on the remote. These menus allow you to add TV channels, adjust the picture and sound, setup external components, and change other settings.

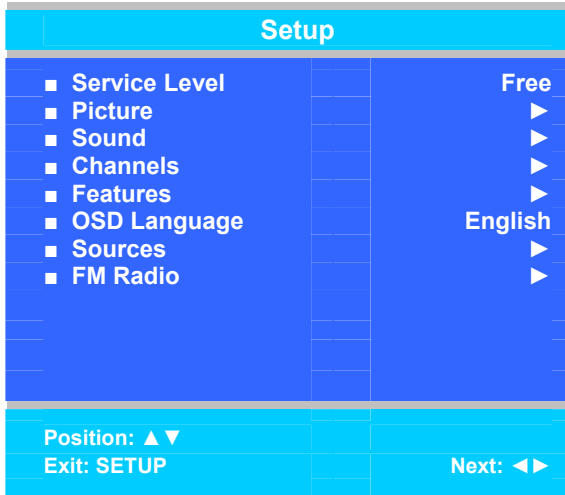

The **SETUP** menu is the first menu that appears. All the other menus and all the settings can be accessed through it. This manual explains and shows how to setup the different features of the PDI-P26/P32/P40LCD TV.

Service Levels

The P26/32/40 contains four separate Service Levels, allowing the hospital to offer either basic or enhanced viewing. The current Service Level can be quickly determined by accessing the SETUP menu using the remote control. The Service Level can be changed to any of the 4 levels at any time by entering the SETUP menu and changing the Service Level menu items.



DISABLED – This is like a mechanical key lock – when in *Disabled* Service Level, the TV can be turned off and on, but it cannot be used for viewing. A standard message appears on a black screen.

FREE – This lets patients watch hospital education and information channels without renting the TV. The channels containing programming for no charge are typically programmed into this level of service. This is the factory default setting for Service Level.

BASIC – This service level typically allows additional channels beyond those offered in the FREE level.

PREMIUM – This is the highest service level with typically the most channels available for viewing.

Picture

This menu allows you to make changes to settings that will change the picture's appearance.

Picture		
■ Brightness		65
■ Contrast		70
■ Color		75
■ Tint		0
■ Color Temperature		▶
■ Sharpness		60
■ PC Analog/HDMI Picture		▶
■ Component Input Picture		▶
Position: ▲ ▼		
Exit: SETUP		Next: ◀ ▶

1. Press the SETUP button on the remote control.
2. Press ▲ or ▼ to highlight Picture.
3. Press ▶ to enter the Picture sub-menu.

Brightness, Contrast, Color, Tint, and Sharpness

These settings have a range of 1-100. To change one of them, change the number by following this process.

1. Enter the Picture menu
2. Press ▲ or ▼ to highlight the setting you want to change.
3. Press ◀ or ▶ to the desired number.
4. Press SETUP to return to the previous menu. To exit, press SETUP until the programming menus disappear.

Color Temperature

Color Temperature adjusts the color balance of the picture. Standard, Reddish, Greenish, and Bluish are preset adjustments. You can customize the color temperature with the User setting.

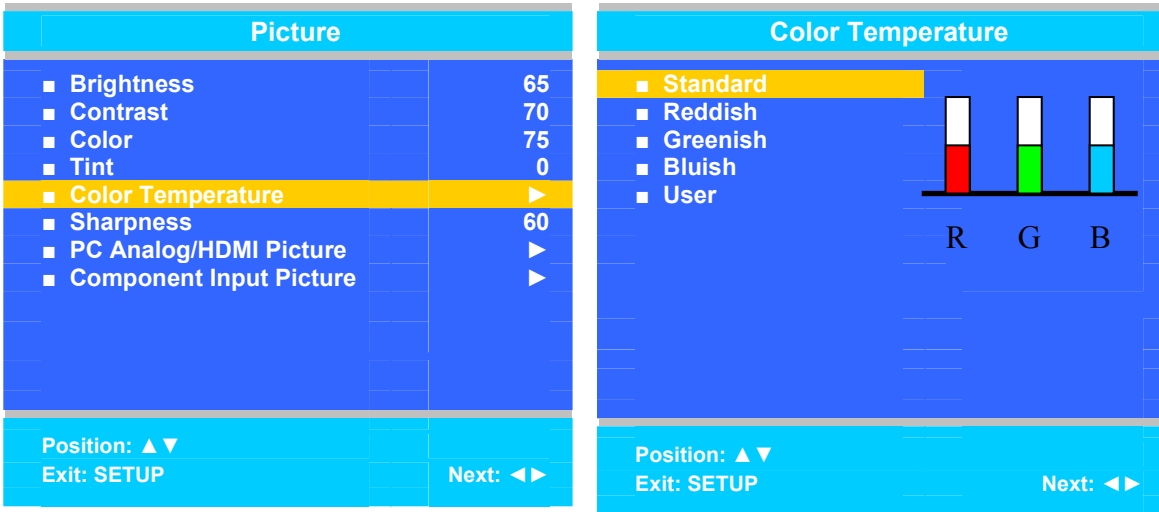

1. Enter the Picture menu
2. Press ▲ or ▼ to highlight Color Temperature.
3. Access the menu by pressing ►.
4. Press ▲ or ▼ to highlight and select one of the five settings.
5. For User, press ◀ and ▶ to select R, G, or B or to get out of the customized adjustments.
6. Press ▲ or ▼ to adjust R,G, or B
NOTE: When you select one of the three colors to adjust, the other two turn grey.
7. Press SETUP to return to the previous menu. To exit, press SETUP until the programming menus disappear.

PC Analog/HDMI Picture

Adjustment of a computer's picture can made only when the TV is in PC-Analog or HDMI mode.

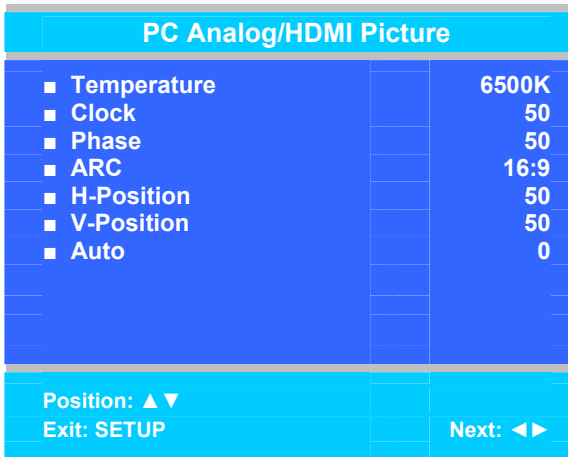

1. Enter the Picture menu
2. Press ▲ or ▼ to highlight PC Analog/HDMI Picture.
3. Access the menu by pressing ►.
4. Press ▲ or ▼ to highlight and select one of the settings.
5. Press ◀ and ▶ to adjust the setting. (See description of settings above)
6. Press SETUP to return to the previous menu. To exit, press SETUP until the programming menus disappear.

Temperature: Temperature is a measure of the warmth of an image. The two temperatures are available 6500K and 9300K.

Clock: Clock adjustment is used to minimize any vertical bars or stripes visible on the screen's background. Adjustment of the clock setting also changes the horizontal screen size.

Phase: The phase adjustment removes any horizontal noise and is helpful in sharpening text characters.

ARC (Aspect Ratio Control): Select the ratio of the screen size (Horizontal: Vertical): 4:3, 14:9 or 16:9.

H-Position (Horizontal Position): The H-Position moves the picture left or right across the screen.

V-Position (Vertical Position): The V-Position moves the picture up or down across the screen.

AUTO: Automatic adjustment of screen position, clock and phase.

Component Input Picture

When the TV's source is set to Component Input additional picture adjustments are available.

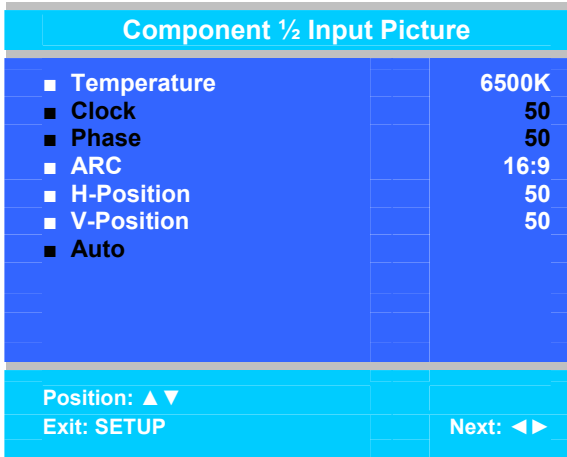

Temperature: Temperature is a measure of the warmth of an image. Two temperatures are available 6500K and 9300K.

ARC (Aspect Ratio Control): Select the ratio of the screen size (Horizontal: Vertical): 4:3, 14:9 or 16:9.

H-Position (Horizontal Position): The H-Position moves the picture left or right across the screen.

V-Position (Vertical Position): The V-Position moves the picture up or down across the screen.

7. Enter the Picture menu
8. Press ▲ or ▼ to highlight Component Input Picture.
9. Access the menu by pressing ►.
10. Press ▲ or ▼ to highlight and select one of the settings.
11. Press ◀ and ▶ to adjust the setting. (See description of settings above)
12. Press SETUP to return to the previous menu. To exit, press SETUP until the programming menus disappear.

Sound

The sound menu allows precise adjustment of several sound parameters.

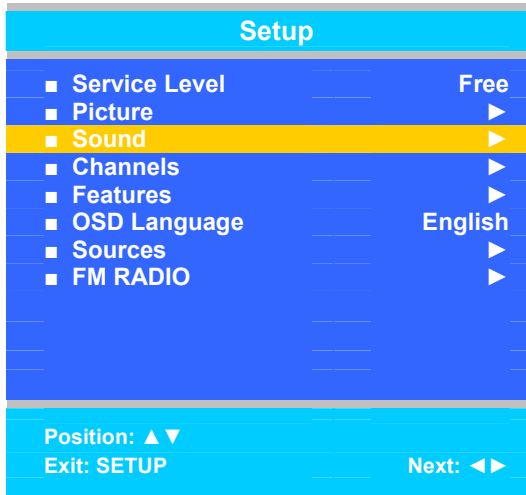

1. Press the SETUP button on the remote control.
2. Press ▲ or ▼ on to highlight Sound.
3. Press ► to enter the Sound sub-menu.

Balance

This controls how the sound is distributed between the left and right speakers.

1. Enter the Sound menu.
2. If Balance is not highlighted, press ▲ or ▼ to highlight it.
3. Press ◀ or ▶ to select the desired number (0-100).
4. Press SETUP to return to the previous menu. To exit, press SETUP until the programming menus disappear.

Minimum Volume

Sets the minimum volume level the TV can reach. Setting this to any value other than 0 guarantees that some level of sound will always be heard when the TV is operating.

1. Enter the Sound menu.
2. Press ▲ or ▼ to highlight Minimum Volume.
3. Press ◀ or ▶ to select the desired number (0-100).
4. Press SETUP to return to the previous menu. To exit, press SETUP until the programming menus disappear.

Maximum Volume

Sets the maximum volume level the TV is allowed to reach.

1. Enter the Sound menu
2. Press ▲ or ▼ to highlight Maximum Volume.
3. Press ◀ or ▶ to select the desired number (0-100).
4. Press SETUP to return to the previous menu. To exit, press SETUP until the programming menus disappear.

Power on Volume

Sets the initial volume for when the TV is turned on.

NOTE: If Power on Volume is set to Last and the physical power is removed, the TV will power on with a volume of 0.

1. Enter the Sound menu
2. Press ▲ or ▼ to highlight Power on Volume.
3. Press ◀ or ▶ to select the desired number (0-100) or Last.
NOTE: Last will cause the TV to be at the last volume setting before it was turned off.
4. Press SETUP to return to the previous menu. To exit, press SETUP until the programming menus disappear.

Internal Speaker Enabled

This allows audio for different sources to be enabled. Sound is also routed externally to the attached pillow speaker.

Sound	
■ Balance	25
■ Minimum Volume	100
■ Maximum Volume	100
■ Power on Volume	Last
■ Internal Speaker Enable	▶
■ HDMI 1 Audio Port	HDMI 1
■ HDMI 2 Audio Port	HDMI 2
Position: ▲ ▼	
Exit: SETUP	Next: ◀ ▶

Internal Speaker Enable	
■ TV	Enabled
■ SLOT1	Enabled
■ SLOT2	Enabled
■ Composite Video	Enabled
■ S-VIDEO	Enabled
■ Component 1	Enabled
■ Component 2	Enabled
■ HDMI 1	Enabled
■ HDMI 2	Enabled
■ PC-ANALOG	Enabled
■ FM RADIO	Enabled
Position: ▲ ▼	
Exit: SETUP	Next: ◀ ▶

1. Enter the Sound menu
2. Press ▲ or ▼ to highlight the component you want to change.
3. Press ◀ or ▶ to select Enabled or Disabled.
4. Press SETUP to return to the previous menu. To exit, press SETUP until the programming menus disappear.

HDMI 1 and 2 Audio Port

Sound can be routed to several other sources when the TV is set to HDMI video. The HDMI Audio Port has three settings: HDMI 1 or 2, PC, and Component 1 or 2.

NOTE: HDMI 1 Audio Port has the settings HDMI 1 and Component 1. HDMI 2 Audio Port has the settings HDMI 2 and Component 2.

1. Enter the Sound menu
2. Press ▲ or ▼ to highlight HDMI Audio Port.
3. Press ◀ or ▶ to select HDMI 1 or 2, PC, Component 1 or 2
4. Press SETUP to return to the previous menu. To exit, press SETUP until the programming menus disappear.

Channels

The Channels menu allows you to program different signal sources into three Service Levels (Free, Basic, and Premium) and to add or delete individual channels. It also allows you to block channels, TV programs, movies, and auxiliary sources that can be input to the TV. Each Service Level contains a different channel map.

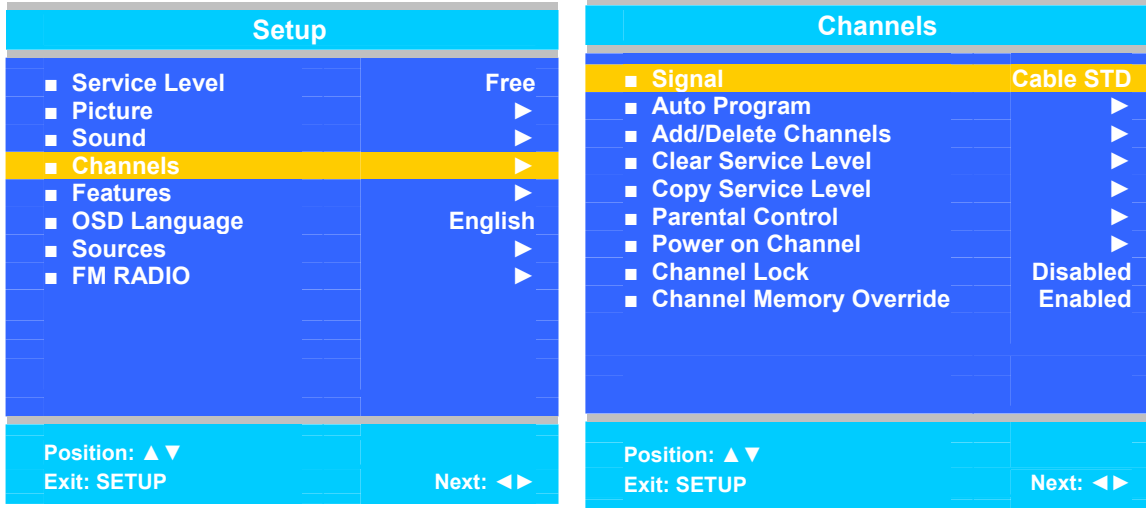

1. Press the SETUP button on the remote control.
2. Press ▲ or ▼ to highlight Channels.
3. Press ▶ to enter the Channels sub-menu.

Signal

Four different tuning types are available depending upon the healthcare facility's signal type. Selection of the correct signal type is required for the TV to recognize all possible channels and before any channel programming can begin.

1. Enter the Channels menu
2. Press ▲ or ▼ to highlight Signal.
3. Press ◀ or ▶ to select Air, Cable STD, Cable IRC, or Cable HRC.
NOTE: Most hospitals use the Cable STD signal style.
4. Now perform Auto Program or Add/Delete Channels to adjust the channels.

Auto Program

The TV automatically scans each available channel for activity. Channels that display activity are memorized into the selected Service Level.

Channels		Auto Program	
■ Signal	Cable STD	■ Mode	Analog Only
■ Auto Program	▶	■ Channel Sequence	Interleave A+D
■ Auto/Delete Channels	▶	■ Add. Digital Signal	None
■ Clear Service Level	▶	■ Free	Programmed ▶
■ Copy Service Level	▶	■ Basic	Blank ▶
■ Parental Control	▶	■ Premium	Blank ▶
■ Power on Channel	▶		
■ Channel Lock	Disabled		
■ Channel Memory Override	Enabled		
Position: ▲ ▼		Position: ▲ ▼	
Exit: SETUP	Next: ◀ ▶	Exit: SETUP	Next: ◀ ▶

1. After setting Signal, press ▲ or ▼ to highlight Auto Program.
2. Press ▶ to select it.
3. On Mode, press ◀ or ▶ to select the scope of channel scanning.
 - Analog Only: TV searches for analog channels only.
 - Digital Only: TV searches for digital channels only.
 - Analog and Digital: TV searches for both analog and digital channels.
4. Press ▲ or ▼ to highlight Channel Sequence.
5. Press ◀ or ▶ to select the Channel Sequence in which the channels are displayed.
 - Interleave A+D: Channels are displayed in the order of channel number.
 - All A then D: All digital channels are displayed after all analog channels.
6. Press ▲ or ▼ to highlight the Service Level (Free, Basic, or Premium) you wish to program. The menu displays the current programming status of each level as either Programmed or Blank.

NOTE: A programmed service level can also be reprogrammed if desired.
7. Press ▶ to start auto programming.
8. A confirmation menu will appear before proceeding. Press ▲ to start auto programming. Press ▼ to cancel the operation. The TV now will search all available channels. Auto programming requires several minutes to complete.

NOTE: Digital channel auto programming may take longer than 10 minutes to complete.
9. Press the SETUP button to return to normal TV viewing.

Add/Delete Channels

Individual analog TV channels that are missing can be manually added to a Service Level (Free, Basic, or Premium). Analog channels that require deletion can be manually removed from a Service Level. Digital channels found during auto programming can be enabled or disabled in each Service Level.

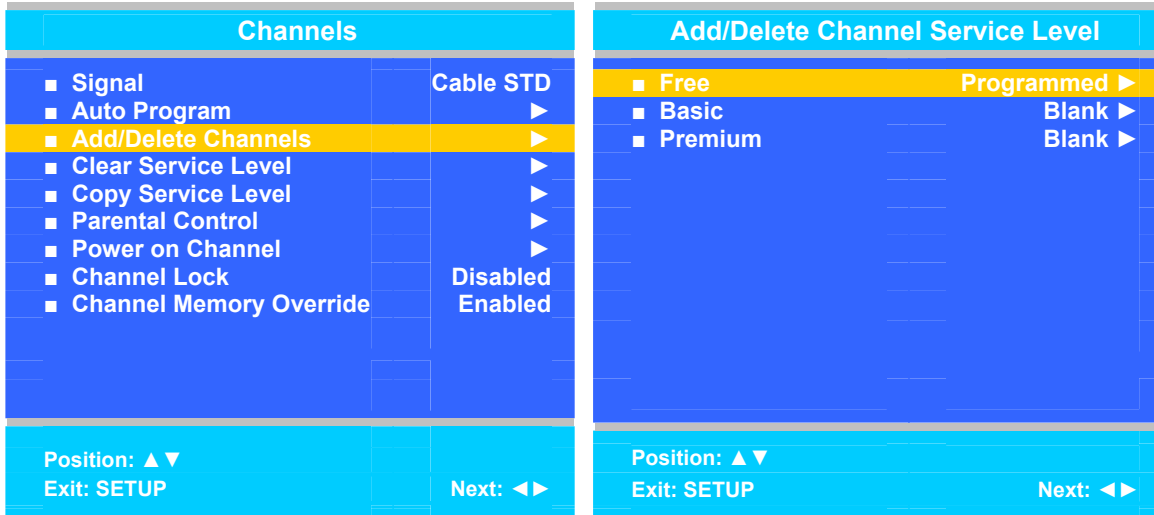

1. Enter the Channels menu
2. Press ▲ or ▼ to highlight Add/Delete Channels.
3. Press ▶ to select it.
4. Press ▲ or ▼ to highlight the Service Level (Free, Basic, or Premium).
5. Press ▶ to select the highlighted Service Level.
6. If you want to add or delete an analog channel, press ◀ or ▶ to select the desired analog channel. If you want to enable or disable digital channels, go to step 10.

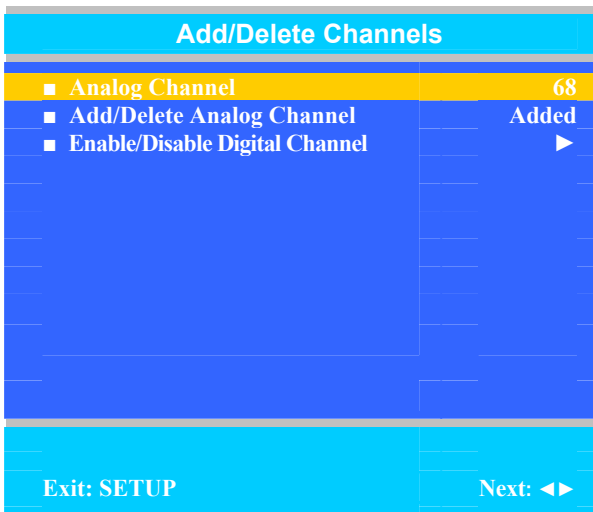

7. After you have selected the desired analog channel, press ▲ or ▼ to highlight Add/Delete Analog Channel.
8. Press ◀ or ▶ to select Added or Deleted.
9. If you are done, press SETUP to return to the previous menu. To exit, press SETUP until the programming menus disappear. If there are more analog channels to be added or deleted, repeat steps 6 through 8. For enabling or disabling digital channels, go to the next step.
10. Press ▲ or ▼ to highlight Enable/Disable Digital Channel.

11. Press ► to select Enable/Disable Digital Channel.
NOTE: If there are not any channels programmed in the Service Level, “No Channels Present” will appear in the menu.
12. Press ▲ or ▼ to highlight the digital channel that needs to be enabled or disabled.

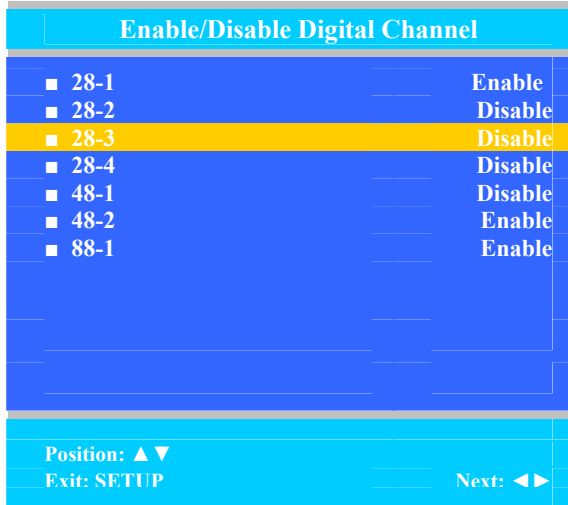

13. Press ◀ or ▶ to select Enable or Disable.
14. Press the SETUP button to return to the previous menu.

Clear Service Level

This empties a service level of all its programmed channels, leaving it blank.

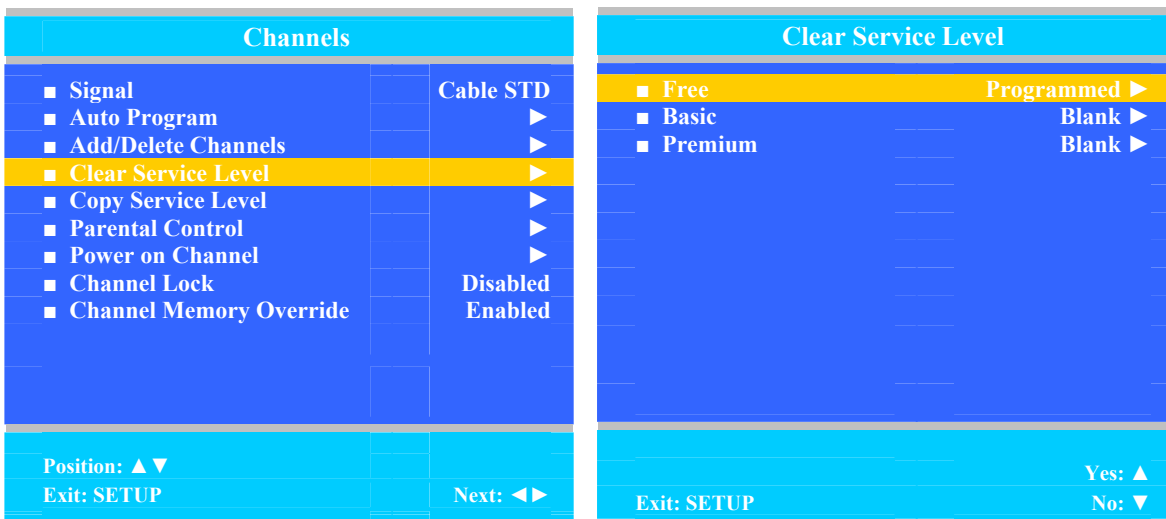

1. Enter the Channels menu
2. Press ▲ or ▼ to highlight Clear Service Level.
3. Press ► to select it.
4. Press ▲ or ▼ to highlight the Service Level (Free, Basic, or Premium).
5. Press ► to select the highlighted Service Level.
6. A confirmation page will appear. Press ▲ to proceed. Press ▼ or SETUP to return to the previous menu.
NOTE: After a Service Level is cleared, the TV returns to the Clear Service Level menu. “Blank” will appear to the right of the Service Level.
7. Press SETUP to return to the previous menu. To exit, press SETUP until the programming menus disappear.

Copy Service Level

This copies one Service Level's channels to another.

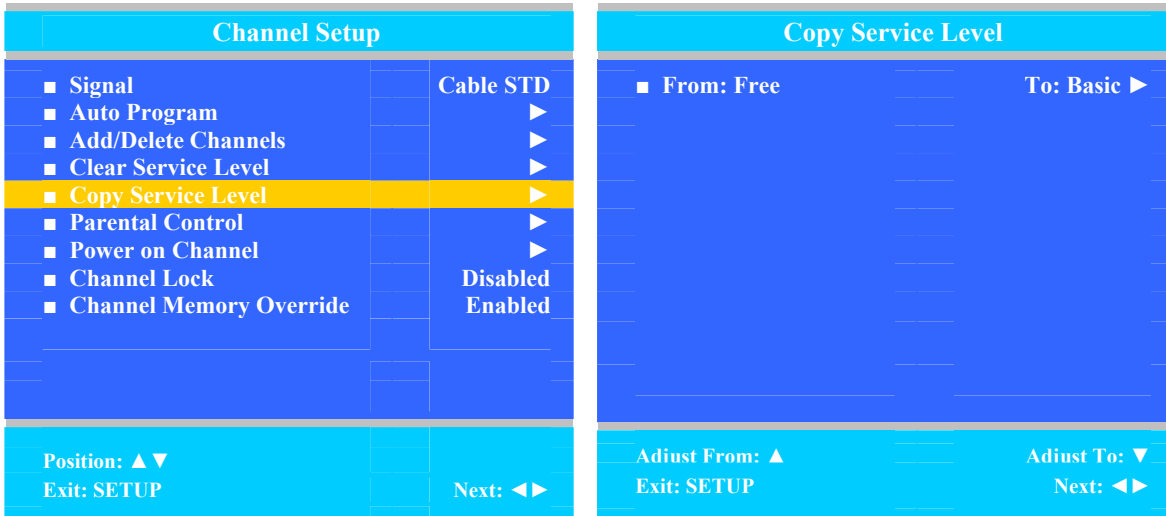

1. Enter the Channels menu
2. Press ▲ or ▼ to highlight Copy Service Level.
3. Press ► to select it.
4. Press ▲ to set the From Service Level. Press ▼ to set the To Service Level.
5. Press ► to copy the Service Level.
6. A confirmation page will appear. Press ▲ to proceed. Press ▼ or SETUP to return to the previous menu.
NOTE: After a Service Level is copied, the TV returns to the Copy Service Level menu. If the To Service Level has been set to active in the Service Level setting (see Service Levels on page 16), TV programming will appear.
7. Press SETUP to return to the previous menu. To exit, press SETUP until the programming menus disappear.

Parental Control

Parental Control allows you to block channels, TV shows, movies, and devices that are connected to the P26/32/40.

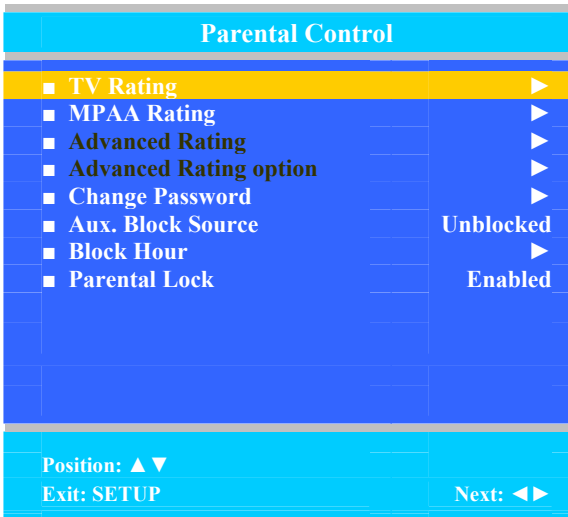

1. Enter the Channels menu
2. Press ▲ or ▼ to highlight Parental Control.
3. Press ► to select it.

TV Rating

Most TV programs are now rated. TV Rating allows the TV to selectively present only programming content that is unblocked per its preset level. A program that is blocked, displays a black screen only.

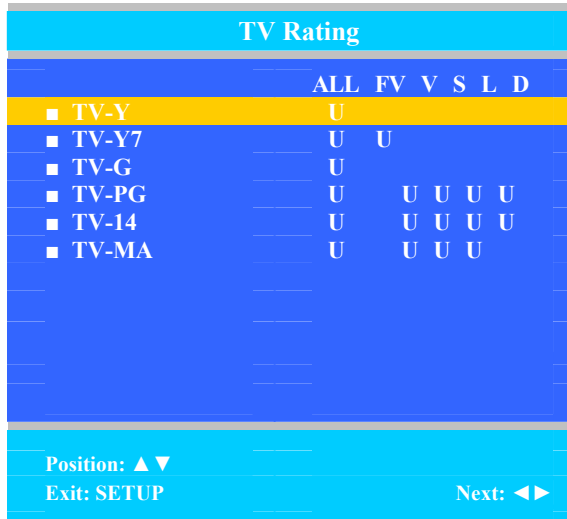

1. From the Parental Control menu, enter the TV Rating menu.
2. Press ▲ or ▼ to move to one of the six age-based categories.
3. Press ◀ or ▶ to cycle through the sub-ratings (ALL, FV, V, S, L or D) or exit out of the sub-categories in that category.
NOTE: The U or B (unblocked or blocked) will turn red when it is highlighted
4. Press ▲ or ▼ to change the sub-rating.
5. Press the SETUP button to return to the previous menu. Or press ◀ to get out of the sub-category.
NOTE: Categories that are rated for older audiences will be automatically blocked. If you block TV-Y category, then TV-Y7 will be blocked automatically. Similarly, if you block TV-G category, then TV-PG, TV-14 and TV-MA will also be blocked.

TV Parental Guideline Rating System

Grade		Meaning
TV-Y	Young Children	Content not offensive to most viewers
TV-Y7	Children 7 and over	Considered suitable for children over 7, may contain Fantasy Violence Scenes.
TV-G	Parental Audience	Considered suitable for all audiences; children may watch unattended.
TV-PG	Parental Guidance	Suggested Unsuitable for younger children, may contain: Suggestive Dialog, Bad Language, Sex, and Violence Scenes
TV-14	Parents Strongly Cautioned	Unsuitable for children under 14, may contain: Strong Dialog, Bad Language, Sex, and Violence Scenes.
TV-MA	Mature Audience Only	Adults only, may contain: Strong Dialog, Bad Language, Sex, and Violence Scenes.

Motion Picture Association of USA (MPAA) Rating System

Grade		Meaning
G	General Audiences	Content not offensive to most viewers
PG	Parental Guidance Suggested	Content is such that parents may not want their children to view the program.
PG-13	Parental Strongly Cautioned	Program is inappropriate for preteens, with a greater degree of offensive material Suggested than a PG rated program
R	Restricted viewing	Not for children under age 17. Strong elements of sex and/or violence.
NC-17	No Children under age 17	Not for children under age 17 under any circumstances. Strong sexual content.
X	Hard Core Films	Same as NC-17 rating.
No Rating	No Rating	MPAA Not Rated

Change Password

The Parental Control access password can be changed using this menu.

NOTE: The factory default password that is programmed into the TV is 0000.

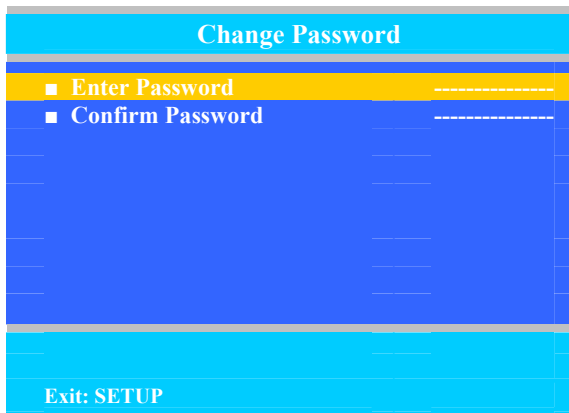

1. From the Parental Control menu, enter the Change Password menu.
2. Enter a new password by using the number buttons on the remote.
3. Confirm the password by entering the same digits.

NOTE: After confirming the password, the TV will return to the Parental Control menu.

Aux. Block Source

Like TV programs and channels, the auxiliary sources can be blocked too. When the TV encounters an external signal source that is not appropriate per its settings, a black screen appears with muted sound.

NOTE: Parental Lock must be enabled for the sources to be blocked.

1. In the Parental Control menu, press ▲ or ▼ to highlight Aux. Block Source.
2. Press ◀ or ▶ to select Unblocked or Blocked.
3. Press SETUP to return to the previous menu. To exit, press SETUP until the programming menus disappear.

Block Hour

This sets how long an enabled Parental Lock will be active.

1. In the Parental Control menu, press ▲ or ▼ to highlight Parental Lock Duration.
2. Press ◀ or ▶ to select the desired number of hours (1-99) or Always.
3. Press the SETUP button to return to the previous menu. To exit, press SETUP until the programming menus disappear.

Inactive Power Off (h:mm)

The TV will automatically power off after a specific period of viewer inactivity, providing energy savings.

1. Enter the Features menu
2. Press ▲ or ▼ to highlight Power Management.
3. Press ◀ or ▶ to select an active time or select Disabled to disable this feature.
4. Press the SETUP button to return to the previous menu. To exit, press SETUP until the programming menus disappear.

NOTE: Auto Power On must be set to Disabled for this function to operate.

Bed A/B

The TV can be controlled by a patient IR remote. The TV offers Bed A and Bed B selectable codes for independent control of a single television in a two television room. The patient remote can be toggled between Bed A and Bed B codes by pressing the CODE button (with a paper clip) on the remote.

1. Enter the Features menu
2. Press ▲ or ▼ to highlight Bed A/B.
3. Press ◀ or ▶ to select A or B.
4. Press the SETUP button to return to the previous menu. To exit, press SETUP until the programming menus disappear.
5. Try the patient remote, PD108-427, to make sure it works with the Bed setting.
6. If it does not, insert a paperclip into the CODE button at the bottom of the remote and hold it in.
7. Try the remote again.

Caption Text Modes

Teletext can be displayed in addition to Captions. Teletext is not normally broadcast in the USA. Caption Text Modes should be set to Disabled for TVs operated in the USA.

1. Enter the Features menu
2. Press ▲ or ▼ to highlight Caption Text Modes.
3. Press ◀ or ▶ to select Disabled or Enabled.
4. Press SETUP to return to the previous menu. To exit, press SETUP until the programming menus disappear.

Digital Captions

Customization of Closed Captions on ATSC/QAM channels.

Digital Captions	
■ Font Size	Default
■ Font Style	Default
■ Foreground Color	Default
■ Background Color	Default
■ Edge Color	Default
■ Foreground Opacity	Default
■ Background Opacity	Default
■ Edge Style	Default
Position: ▲ ▼	
Exit: SETUP	Next: ◀ ▶

1. Enter the Features menu
2. Press ▲ or ▼ to highlight Digital Captions.
3. Press ► to select it.
4. Press ▲ or ▼ to highlight the attribute you wish to change.
5. Press ► to change it. (See the table below for the settings of each attribute.)
6. Press SETUP to return to the previous menu. To exit, press SETUP until the programming menus disappear.

Attribute	Settings
Font Size	default, small, standard, large
Font Style	default, sizes 0 through 7
Foreground Color	default, white, black, red, green, blue, yellow, magenta, cyan
Background Color	default, white, black, red, green, blue, yellow, magenta, cyan
Foreground Opacity	default, translucent, transparent, flashing, solid
Background Opacity	default, translucent, transparent, flashing, solid
Edge Color	default, white, black, red, green, blue, yellow, magenta, cyan
Edge Style	default, none, raised, depressed, uniform, left drop shadow, right drop shadow

Digital Mode Time Setup

The current time will be set automatically from a digital channel signal provided by a broadcasting TV station.

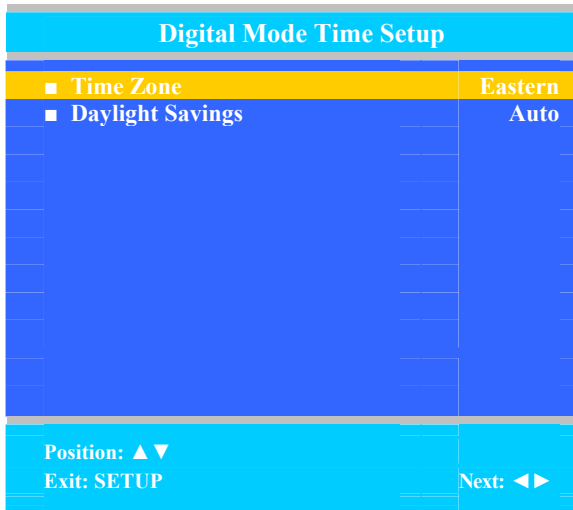

1. Enter the Features menu
2. Press ▲ or ▼ to highlight Digital Mode Time Setup
3. Press ▶ to select it.
4. Press ◀ or ▶ to select your viewing area time zone: Pacific, Alaska, Hawaii, Newfoundland, Atlantic, Eastern, Central or Mountain.
5. Press ▲ or ▼ to highlight Daylight Savings.
6. Press ◀ or ▶ to select Auto, On, or Off depending on whether or not your viewing area observes Daylight Savings Time.
7. Press SETUP to return to the previous menu. To exit, press SETUP until the programming menus disappear.

Power on ARC Mode

The TV powers on with a set screen size aspect ratio of 4:3, 14:9, 16:9, 16:9 Panorama, or Last.

1. Enter the Features menu
2. Press ▲ or ▼ to highlight Power On ARC Mode.
3. Press ► to select 4:3, 14:9, 16:9, 16:9 Panorama, or Last.
4. Press SETUP to return to the previous menu. To exit, press SETUP until the programming menus disappear.

On Screen Menu Language Selection

You can adjust the language used in displaying the (OSD) on screen display.

1. Press SETUP.
2. Press ▲ or ▼ to select the OSD Language menu.
3. Press ◀ or ▶ to select your desired language.



4. Press SETUP to return to the previous menu. To exit, press SETUP until the programming menus disappear.

Sources

The TV's signal sources can be individually Enabled or Disabled. The available sources in this menu correspond with the components you have connected to the TV's connectors. (See page 9 for a picture of connections.)

NOTE: Please disable all of the TV's sources that are not being used. A TV that is switched to a non-connected source generates nuisance hospital maintenance calls of TV Not Working, when in fact the TV does work, but has been set to an inactive source.



1. From the SETUP menu, press ▲ or ▼ to highlight Source.
2. Press ◀ or ▶ to select it.
3. Press ▲ or ▼ to highlight a desired source.
4. Press ◀ or ▶ to change the source status to either Disabled or Enabled/APO (Auto Power Off).
NOTE: Sources that are grayed out are not installed in the TV. For the TV source, Enabled/APO means the TV will turn off if there is no video.
5. Press SETUP to return to the previous menu. To exit, press SETUP until the programming menus disappear.

Power on Source

The TV can be preset to power on to a selected source.

1. Enter the Sources menu
2. Press ▲ or ▼ highlight Power On Source.
3. Press ◀ or ▶ to change to the source that you want the TV to power on to.
NOTE: The source must be enabled before it can be chosen as a power on source. The Last entry causes the TV to power on to the Last source selected.
4. Press SETUP to return to the previous menu. To exit, press SETUP until the programming menus disappear.

FM Radio

You can listen to FM radio stations that are combined with the cable TV signals using this TV.



Auto Program

This will search for active radio stations to program into the P26/32/40's FM tuner.

1. Press ▲ or ▼ to highlight FM Radio.
2. Press ▶ to enter it.
3. Press ▲ or ▼ to highlight Auto Program
4. Press ▶ to select it.
5. A confirmation page will appear. Press ▲ to proceed. Press ▼ or SETUP to return to the previous menu.

Add/Delete Stations

1. Press ▲ or ▼ to highlight Frequency.
2. Press ◀ or ▶ to select the frequency you wish to add or delete.
3. Press ▲ or ▼ to highlight Add/Delete.
4. Press ◀ or ▶ to select Added or Deleted.
NOTE: When you return to the normal viewing screen, a station you deleted will be playing. Press ▲ or ▼ to tune to another station. Now the station is deleted. You cannot go back to it.
5. Press the SETUP button to return to the previous menu. To exit, press SETUP until the programming menus disappear.

Cloning

Cloning allows quick programming of a TV from an SD Card. The operation involves first downloading setup information from a programmed host TV to an SD Card and then uploading the setup information to another TV. Cloning can also be used to re-program a programmed TV.

Save Settings to SD Card

1. Using a computer, create a folder called “PDITDF” on an SD Card.
2. Turn on the TV.
3. Insert the SD Card into the SD slot on the connector panel of the TV. (See connections picture on page 9). A Cloning Main Menu will appear.
4. Press ▲ or ▼ to highlight Save Settings to SD Card.
5. Press ► to display Save Settings to SD Card.

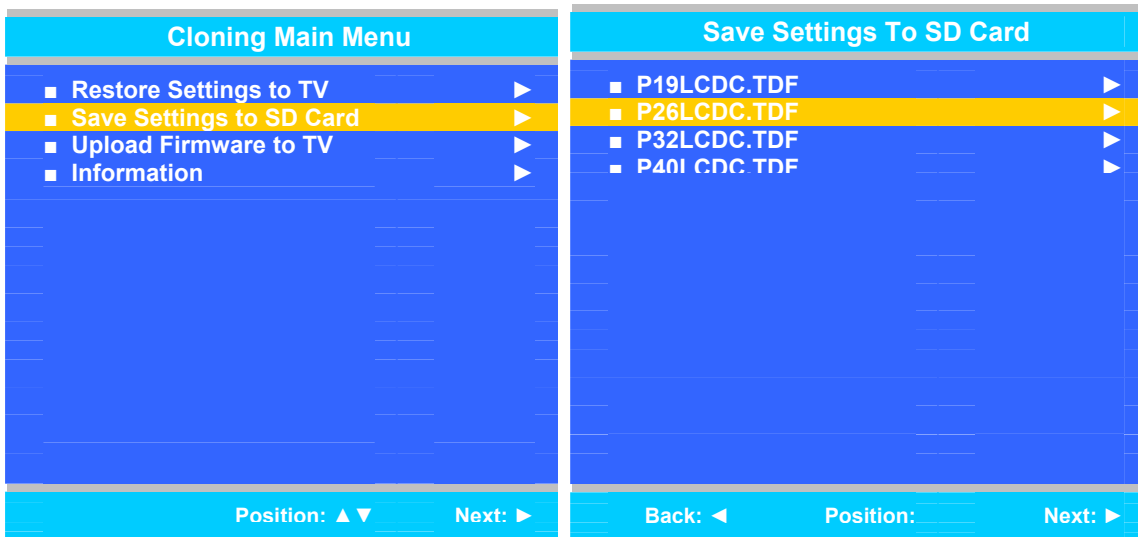

6. Press ▲ or ▼ to highlight the file for the TV.
NOTE: The file name might be different than what is shown in the above, right screen shot.
7. Press ► to download the TV's setup to the SD Card. A progress screen will be displayed.

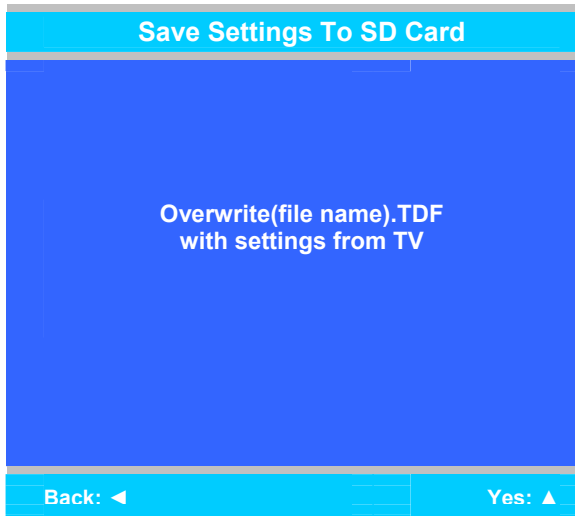

8. A confirmation screen will appear. Press the ▲ to start the process or press ◀ to return to the previous menu.
9. A progress screen will appear as the settings are restored. Press ◀ twice to return to the Cloning Main Menu.
10. Remove the SD Card to return to normal TV operation.

Restore Setting to TV

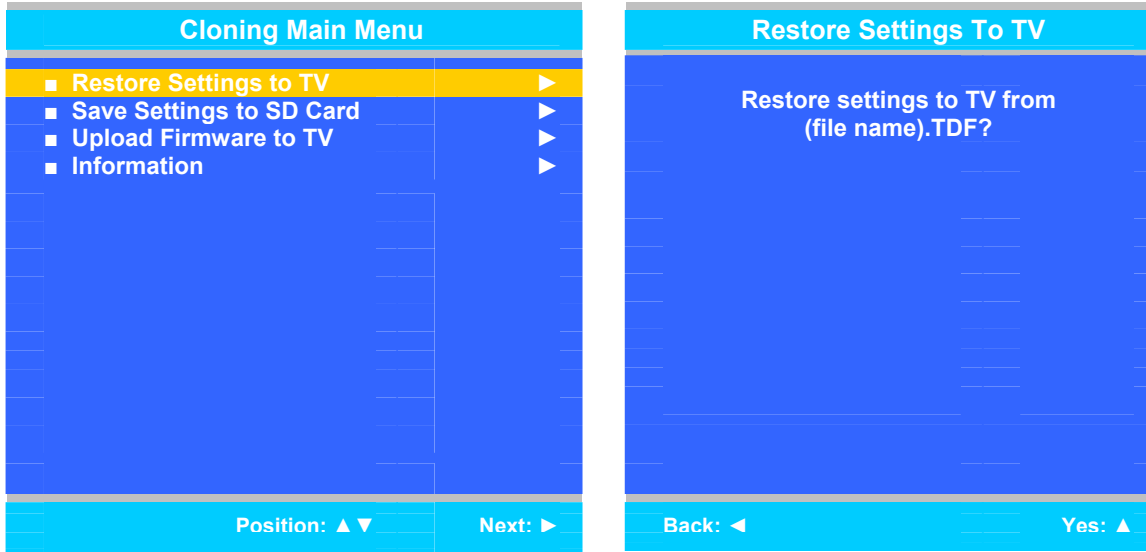

1. Press ▲ or ▼ to highlight Restore Settings to TV.
2. Press ► to display a list of previously stored TV setups on the SD Card.
3. Press ▲ or ▼ to highlight the desired setup file.
4. Press ► to select it.
5. A confirmation screen will appear. Press the ▲ to start the process or press ◀ to return to the previous menu.
6. A progress screen will appear as the settings are restored. Press ◀ twice to return to the Cloning Main Menu.

Information

This is a read-only menu that allows you to check what version of firmware the TV is using.



1. In the Cloning Main Menu, press ▲ or ▼ to highlight Information.
2. Press ► to select it.
3. Press ◀ to return to the previous menu.

Firmware

The firmware for the model PDI-P26/P32/P40LCD is field upgradeable. A data file is written to an SD Card, connected to the TV's cloning port (See page 8.), and updated using the TV's menus. Once complete, the TV settings must be reprogrammed.

1. There needs to be a file called config.txt in the PDITDF folder the SD Card before settings can be saved. If you DO NOT have the files, contact PDi Communication technical support.
NOTE: If the file is not on the SD Card or not in the PDITDF folder, a screen will appear that says the file is not in the PDITDF folder when you perform step 4.
2. Insert the SD Card into the cloning port of the TV.
3. When the cloning menu appears, press ▲ or ▼ to highlight Upload Firmware to TV.
4. Press ►. An Upload Firmware to TV menu appears.

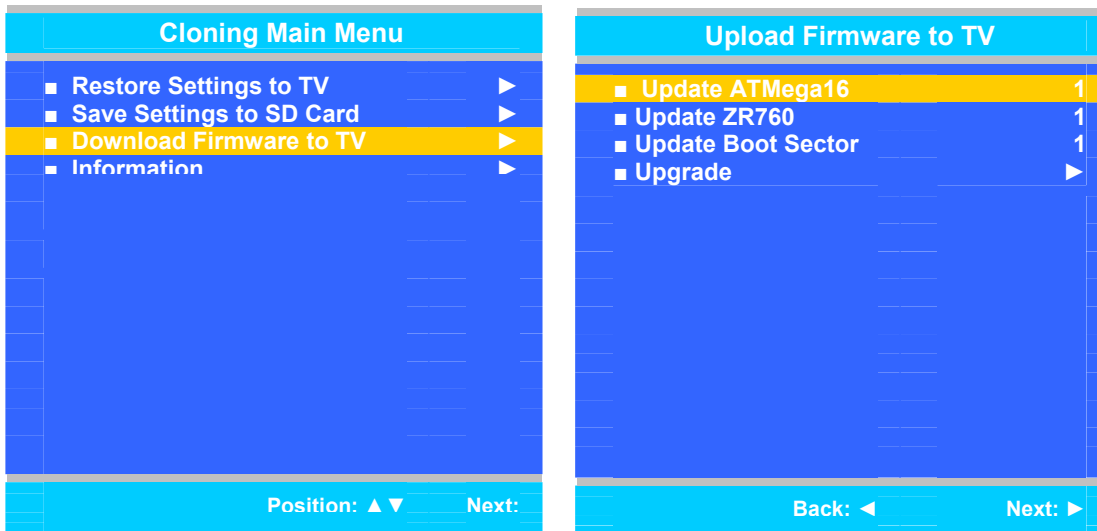

5. Press ▲ or ▼ to highlight Update ATmega16, Update ZR760, and Update Boot Sector
6. Press ► to set each one to 1.

ATmega16

I/O firmware

ZR760

Main firmware

Boot Sector

Firmware that operates when the power button is pressed

7. Press ▲ or ▼ to highlight Upgrade
8. Press ► to select Upgrade and follow the on-screen prompts to complete the firmware update process.

DVD Module

The DVD module for the P26/P32/P40 unit can play DVDs and CDs. It can also display JPEG images. To control the module, use the controls on the right side of the TV, a patient remote control (PD108-427), or the pillow speakers.

NOTE: *Not all pillow speakers can operate the DVD module. (See the instructions that came with your pillow speaker for more information.)*



BEFORE INSTALLING THE DVD MODULE, THE TV'S AC POWER CORD **MUST BE DISCONNECTED** FROM THE OUTLET. FAILURE TO DO THIS BEFORE INSTALLING THE DVD MODULE WILL RESULT IN **CATASTROPHIC DAMAGE** TO THE MODULE AND/OR TV.

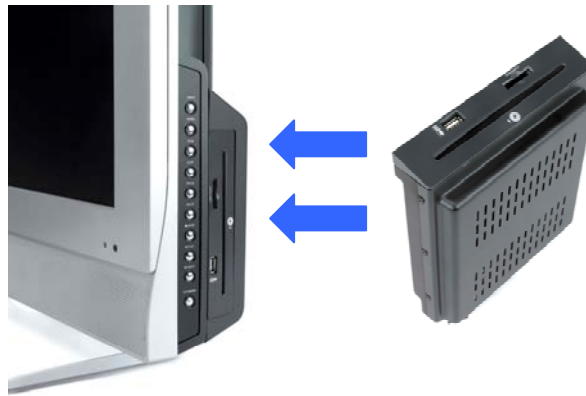

Install DVD module

1. Remove the Side Panel by pressing on the two plastic tabs.
2. Connect the cable to the DVD module. Tighten with the thumb screws on both sides of the cable.

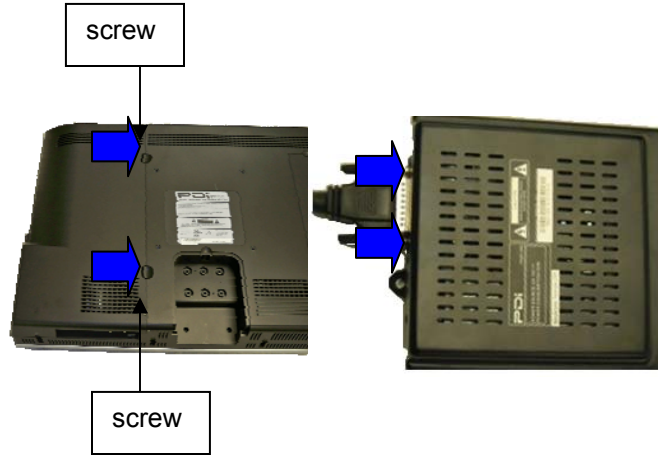

3. Slide the DVD module into one of the three positions.



Sideways



Bottom



Top

4. Connect the other end of the cable to one of the connectors on the side of the TV. Tighten with the thumb screws on both sides of the cable.



Note: If you are going to mount the DVD in the top position it is easier to connect the cable to the bottom connector on the TV. If you mount it in the sideways or bottom positions, the top connector is better.

5. Line up the screw hole on the module with the corresponding screw hole in one of the three positions.
6. Secure the module with the screw that came with it.



Enable DVD Module

Now that you have the DVD module installed, it needs to be enabled by using the programming menus. After the DVD module is enabled, it is ready for use. Use the following procedure with a programming remote (PD108-420).

Setup			Source		
■ Service Level		Free	■ TV		Enable/APO
■ Picture		▶	■ Composite Video		Enable/APO
■ Sound		▶	■ S-VIDEO		Enable/APO
■ Channels		▶	■ Component 1		Enable/APO
■ Features		▶	■ Component 2		Enable/APO
■ OSD Language		English	■ HDMI 1		Enable/APO
■ Sources		▶	■ HDMI 2		Enable/APO
■ FM RADIO		▶	■ PC-ANALOG		Enable/APO
			■ FM RADIO		Enabled
			■ SLOT1 DVD		Enable/APO
			■ SLOT2		Disabled
			■ Power on Source		Last
Position: ▲ ▼			Position: ▲ ▼		
Exit: SETUP		Next: ◀ ▶	Exit: SETUP		Next ◀ ▶

1. Plug the power cable into the wall outlet.
2. Turn on the TV.
3. Press SETUP on the programming remote.
4. From the SETUP menu, press ▲ or ▼ to highlight Sources.
5. Press ▶ to select it.
6. Press ▼ to highlight SLOT 1 or 2. ("DVD" will be to the right of the SLOT you need to enable.)
7. Press ◀ or ▶ to change the source status to Enabled/APO.
8. Press the SETUP button to return to the previous menu.

Insert DVD

1. Make sure the TV is in DVD mode.
 2. Insert a DVD with the label side facing the same direction as the front of the TV.
- NOTE:** *Some DVDs can be played on either side.*

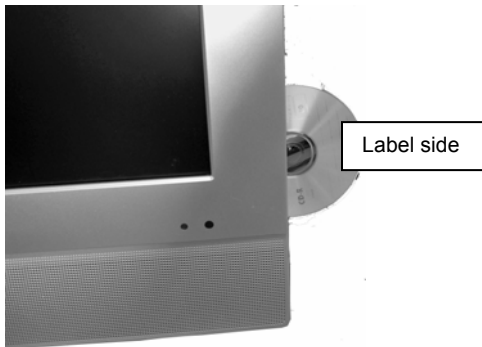

Basic DVD functions

Play: After loading a DVD disc, the disc's menu will appear on the screen, if the disc includes a menu. Press **▶** Play to start playback.

Stop: During playback, press **■** Stop once to stop playback and then press **▶** Play to resume. Press **■** Stop twice to cancel Last Memory (Last Memory remembers the last place stopped on a disc, so it can be returned to by pressing Play.)

Pause: During playback, press **⏸** Pause once to pause the playback. Press it repeatedly to start step-by-step playback. Press the **▶** Play button to resume normal playback.

Previous and Next: During playback, press **▶** to go to the next chapter or track. Press **◀** once to return to the beginning of the current chapter; press it twice to go to the previous chapter.

Fast Playback: During playback, press **⏩** to activate fast forward playback; press **⏪** to activate fast backward playback. During fast playback, press the **▶** Play button to resume normal playback.

Navigating menus

On the PD108-427 remote, the OK button and the directional buttons that surround it can be used to select the menu item choices on a DVD. (e.g. Scene Selection and Bonus Features.) Use the four directional buttons to move to the desired menu item, and press the OK button to select it.

Advanced DVD playback features

Besides the basic controls for playing, pausing, rewinding, and advancing through a DVD, there are other functions that can be performed during playback.

Repeating a Chapter or Title

1. Press the REPEAT button, at the bottom of the remote, to cycle through the selections: Title, Chapter, or All.
2. Stop pressing REPEAT when the desired selection appears on screen.

Changing the Subtitle and Audio

Many DVDs have the ability for their content to be played back in various languages or other types of audio outputs. They also have the ability to display subtitles in various languages.

Audio

1. To set the audio to a certain type of language, types of audio output, or commentary, press the AUDIO button to cycle through the choices.
2. Stop pressing AUDIO when the desired selection appears on screen.

Subtitle

1. To set a Subtitle in a certain language, press the SUBTITLE button to cycle through the choices.
2. Stop pressing SUBTITLE when the desired selection appears on screen.

DVD Content Information

While the DVD is playing, you can view different types of information about the content, such as what chapter is being played or what subtitle is set. The table below shows different categories of information and what can be changed.

1. Press GOTO, at the bottom of the Patient remote.
2. Press ▲ or ▼ to highlight the desired category
3. Press OK to select the category.
4. If there is a number to be entered, use the number buttons.
NOTE: Once a digit is entered, the next digit will be ready to be entered. The directional buttons WILL NOT work
5. If it is a list of choices, do the following.
 - a. Press ▲ or ▼ to highlight the desired choice.
 - b. Press OK to select the item.
6. Press GOTO to return to normal viewing.

Category	Options
Title	Displays the current title. This can be changed if the DVD has multiple titles and it allows you to change them.
Chapter	Displays the current chapter. This can be changed if the DVD has multiple chapters and it allows you to change them.
Audio	Displays the current audio setting. This can be changed to another available language or audio output.
Subtitle	Displays the current subtitle setting. This can be changed to another available subtitle.
Angle	Some DVDs have scenes where multiple angles have been recorded. You can change the angle of a scene.
TT Time	This shows the length of the playing title. You can enter a time, and the disc will go to that time.
CH Time	This shows the length of the playing chapter. You can enter a time, and the disc will go to that chapter and time.
Repeat	Chapter, Title, All, Off
Time Display	Title Elapsed, Title Remain, Chapter Elapsed, Chapter Remain

CD Playback

Inserting disc

1. Make sure TV is powered.
2. If the SLOT 1 or 2 DVD source is not already displayed, press **TV/AV** on the TV or remote until it is displayed.
3. Gently insert the disc into the slot, with the label side facing the same direction as the front of the TV.

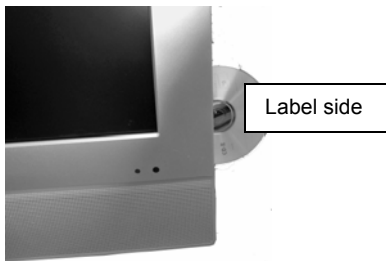

Basic controls

Playback: The disc will be drawn into the unit and loaded automatically. Press the **▶ Play** button to start playback.

NOTE: Playback might start automatically with Track 1 when the disc is first inserted.

Stop: During playback, press **■ Stop** once to stop playback and then press **▶ Play** to resume.

Pause: During playback, press the **⏸ Pause** button once to pause the playback; press it repeatedly to start step-by-step playback and press the **▶ Play** button to resume normal playback.

Skip to next track/Return to previous track: During playback, press the **⏭** button to go to the next track. Press the **⏮** button once to return to the beginning of the current track; press it twice to go to the previous track.

NOTE: The number buttons also can be used to enter track numbers.

Fast forward/Rewind: During playback, press the **⏭** button to activate fast forward playback; press the **⏮** button to activate fast backward playback. During fast playback, press the **▶ Play** button to resume normal playback.

NOTE: The FFD/RWD speeds are x2, x4, x8, x16, x32.

Mute: Press the MUTE button to turn the sound on and off.

Volume: VOL +/- to control the volume level.

Advanced CD playback features

Besides the basic controls for playing, pausing, rewinding, and advancing through a CD, there are other functions that can be performed during playback.

Setting a track or whole CD to loop

1. Press the REPEAT button, at the bottom of the remote, to cycle through the selections: Track, All, or Off.
NOTE: Off will not appear on the screen. In this setting the CD will play through once then stop.
2. Stop pressing REPEAT when the desired selection appears on screen.

Skipping to a certain place on a CD

1. Press the GOTO button, at the bottom of the remote, to cycle through the selections: Disc Go To, Track Go To, or Select Track.
2. Stop pressing GOTO when the desired selection appears on screen.
3. Use the number buttons to enter the desired time or track.
NOTE: Once a digit is entered, the next digit will be ready to be entered. These directional buttons WILL NOT work.

Adjusting Audio output

The audio output can be set four ways: stereo, mono left, mono right, or mix-mono

1. Press the AUDIO button, at the bottom of the remote, to cycle through the selections.
2. Stop pressing AUDIO when the desired selection appears on screen.

Viewing JPG photos on a USB drive, Media card, or data CD

USB port and card reader

The DVD module has a USB port and an SD/MS/MMC card reader that allows JPEG images to be displayed on the TV screen. To view images stored on a USB drive or media card, follow these steps with patient a remote (PD108-427).

NOTE: The DVD module WILL NOT recognize media cards with more than 2GB of storage space. It will recognize USB drives with more than 2GB of space.

1. Insert a USB drive into the USB port and/or media card into the card reader.
2. Press the CARD button on the patient remote.
“Wait” will appear on the screen before the drive or card’s directory is accessed
3. Once the directory appears on screen, press the ▼ direction button that is located below the OK button to highlight the desired image or folder.
4. Press the ► directional button to access the contents of a particular folder or to view an image full screen. If there are several images in a folder, they will be cycled through full screen once before returning to the directory.
5. Press CARD to return to the DVD mode screen.

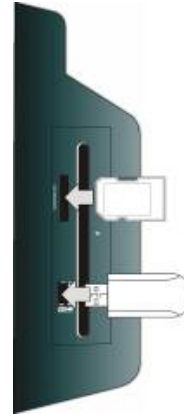

Access USB/SD Card

1. Insert SD card or USB into corresponding slots
2. Press CARD to Display menu
3. Press ▼ to highlight Media
4. Press ► to select it.
5. Press ▼ or ▲ to highlight SLOT 1 USB or SD
NOTE: If one is inserted only one will appear.
6. Press OK

Access Photo CD

1. Press CARD to Display menu
2. Press ► to select Media
3. Press OK

View JPEG

1. Press ▼ or ▲ to highlight to highlight desired picture or folder
2. Press OK to select picture. Press OK or ► to access a folder.
NOTE: It may take a minute for pictures to show full screen.
3. Press MENU to return to the selection window.

Control Slide Show

1. Basic controls
 - a. >>| button. Forward to next picture
 - b. << button. Go back to previous picture
 - c. Pause. The displayed picture remains on screen. Slide show halts.
2. Rotate pictures. Use the directional buttons to rotate a picture clockwise or counter-clockwise.
3. Change how the slide show cycles through pictures
Press REPEAT button again and again to cycle through Shuffle, Repeat Off, Repeat All, Random, Repeat One, and Single

Selecting Thumbnail Photos

You can stop the slide show and select an individual photo by entering a thumbnail screen

1. While slide show is playing, press STOP access a thumbnail menu
2. Press ◀ or ▶ to highlight thumbnail photo
3. Press OK to select it

Selecting More Thumbnails

If there are many photos stored in the file you are viewing, not all the thumbnails for them will appear at the same time. Use the following steps to view more of them.

1. Press ▼ to access bottom menu items
2. Press ◀ or ▶ to highlight Prev. or Next
 - a. Prev. – previous set of thumbnails
 - b. Next –next set of thumbnails
3. Press OK to select it

Other Thumbnail Screen Controls

1. Press ▼ to access lower menu items
2. Press ◀ or ▶ to highlight Slide Show or Menu
 - a. Slide Show – return to slide show
 - b. Menu – read-only menu with instructions for basic controls
3. Press OK to select it

Setup menu

Like the TV, the DVD module has a Setup screen that allows you to set various features. (See the table on page50 for a description of the menus and what categories and settings they contain.)



1. Press SETUP.
2. Press ◀ or ▶ to highlight the desired Setup Page.
3. Press OK to select it.
4. Press ▲ or ▼ to highlight the desired category selection.
5. Press OK to select it.
6. Press ▲ or ▼ to highlight the desired option.
7. Press OK to select it.
NOTE: Some options may take you to an adjustable meter. Use ◀ and ▶ to adjust the meter.
8. If you are done, go to next step. If not, press ◀ to back out of each selection.
9. Press SETUP to return to normal viewing.

Menu sections	Categories	Options	Options (continued)	Description
General Setup Page	TV Display (when DVD is not inserted)	4:3/Pb, 4:3/Lb, 16:9, Wide squeeze		Adjusts the aspect ratio of the image or video.
	Angle	On, Off		Allows for other angles of a scene in a video to be viewed (if other angles have been recorded on the DVD)
	OSD Lang	English, French, Spanish, German, Italian		Changes the languages of the Setup menus
	Captions	On Off		Turns captions ON or OFF
	Screen Saver	On Off		Turns screensaver ON or OFF
	Last Memory	On Off		When set to ON, the module will start to play the disc where it was last stopped.
	Media Center	USB, SD/MMC, MS		Switches to another type of media that is inserted into the module.
Audio Setup Page	Dolby Digital Setup	Dual Mono	Stereo, L-Mono, R-Mono, Mix-Mono	Dual Mode and Dynamic allow the difference between high and low sounds to be adjusted for each of the four settings: Stereo, L-Mono, R-Mono, and Mix-Mono
		Dynamic	Meter. Use ▲ and ▼ buttons to adjust	
	HDCD	Off 1x 2x		A filter can be set for HDCDs
Video Setup Page	Quality	Sharpness, Brightness, Contrast		Adjust 3 setting meters: -20 to 20
	DivX VOD	OK		Video On Demand service that allows video to be rented and purchased.
Preference Page (w/o DVD inserted)	Audio	English, French, Spanish, Chinese, Japanese, Korean, Russian, Thai		Change the language spoken on a video(if the DVD offers the language)
	Subtitle	French, Spanish, Chinese, Japanese, Korean, Russian, Thai, Off		Set the language in which subtitles will be displayed(if the DVD offers the language)
	Disc Menu	English, French, Spanish, Chinese, Japanese, Korean, Russian, Thai		Changes the languages of menus of the DVD menus(if the DVD offers the language)
	Parental	Kids Saf, G, PG, PG-13, PGR, R, NC-17, Adult		The password will be required if an inserted movie is at a level that is equal to or higher than what is set.
	Default	Reset		Resets module to factory settings
Password Setup Page	Password Mode	On, Off		If set to On, the password will be required in order to change the Parental options or watch a movie that is at a rating level equal to or higher than what is set in the Parental category.*
	Password	Change		Allows for a new password to be set
Exit Setup Menu				Close Setup menu

*The default password from the factory is '0000'

Limited Warranty

PDI Communication Systems Inc., ("PDI") warrants, to the original purchaser only, that the PDI-P26/32/40 will be free from defects in materials and workmanship, under normal use, for 2 years from the date of original purchase. This warranty does not cover any other equipment that may have been included with PDI's shipment of this product.

After receipt of written notice of a defect or malfunction occurring during the warranty period, PDI will repair or replace goods returned to its Springboro, Ohio location, at its discretion, free of charge to the original purchaser, the whole or any component part of any product manufactured by PDI and found by PDI to be defective.

As a condition to obtaining warranty service, written notification must be received by PDI within at least ten (10) days after defect is first observed. Repair of said product requires it to be shipped to the PDI factory in Springboro, Ohio. All shipments shall be F.O.B. Springboro, Ohio, and all shipping and freight charges to PDI's factory shall be paid by the customer.

This warranty shall not apply to any PDI products subjected to improper use, negligence or accident; nor to tampering, alterations, or repairs by others, without PDI's specific prior written authorization. For information regarding authorized servicing and all other information pertaining to this warranty, please contact PDI COMMUNICATION SYSTEMS, Inc. at 40 Greenwood Lane, Springboro, Ohio 45066 or phone 937-743-6010.

This warranty gives specific legal rights and you may also have other rights which vary from state to state.

PDI's liability under this warranty is limited to repair or replacement of defective products and parts as provided above. PDI shall not be liable for incidental or consequential damages.*

The warranty contained herein is in lieu of all other expressed or implied warranties, including any implied warranty of merchantability or fitness for any particular purpose. PDI neither assumes nor authorizes any person to assume, on its behalf, any other obligation or liability.

*Some states DO NOT allow the exclusion of limitation of incidental or consequential damages or a disclaimer of warranties implied by law, so the above limitation or exclusion may not apply.

The information and technical data in this manual is believed accurate, but is not warranted and is subject to change without notice or obligation.

"PDI" and "Better Solutions Are Within Reach" are registered trademarks of PDI Communication Systems, Inc.

Copyright © 2004-2009 by PDI Communication Systems, Inc.

All rights reserved