

**Installation
and
Operating
Instructions**



**P19 Hospital Grade TV
Model: PDI-P19LCDC**

PDI

Communication
Systems, Inc.

40 Greenwood Lane
Springboro, Ohio 45066

PH: 937-743-6010

FX: 937-743-5664

<http://www.pdiarm.com>

Better Solutions Are Within Reach[®]

WARNINGS

To reduce the risk of electric shock, DO NOT perform any servicing other than what is contained in the operating instructions, unless you are qualified to do so.



This symbol is intended to alert the user of the presence of un-insulated 'dangerous voltage' within the product's enclosure that may be of sufficient magnitude to constitute a risk of electric shock to persons.



This symbol is intended to alert the user of the presence of important operating and maintenance (servicing) instructions in the literature accompanying the appliance.

NOTE TO CABLE TV INSTALLER

This reminder is provided to call the cable TV systems installer's attention to Article 820-40 of the National Electrical Code. The code provides guidelines for proper grounding and, in particular, specifies that the cable ground shall be connected to the grounding system of the building, as close to the point of the cable entry as practical.

SAFETY INSTRUCTIONS

INSTRUCTIONS

Be sure to read, follow, and keep these instructions. Heed all the warnings.

MAINTENANCE AND SERVICING

Servicing is required when the TV has been damaged in any way, such as the power-supply cord or plug is damaged, liquid has been spilled or objects have fallen into the TV, the TV has been exposed to rain or moisture, does not operate normally, or has been dropped.

Never remove the back cover of the TV; this can expose you to high voltage and other hazards. If the TV does not operate properly, unplug it and call an authorized service center or PDI.



CAUTION: These servicing instructions are for use by qualified service personnel only.

POWER CORD

Protect the power cord from being walked on or pinched particularly at the plugs, convenience receptacles, and the point where they exit from the apparatus.

To avoid any malfunctions of the unit and unwanted electric shock or fire accidents, please observe the following:

- Hold the plug firmly when connecting or disconnecting the AC power cord to/from an outlet.
- DO NOT connect or disconnect the AC power cord when your hands are wet.
- Keep the AC power cord away from heating appliances.
- Never put heavy objects on the AC power cord.
- DO NOT attempt to repair or reconstruct the AC power cord under any circumstance.
- Remove dust, dirt, etc. from the plug periodically.
- If the unit has been dropped or otherwise damaged, turn off the power and disconnect the AC power cord from the outlet.
- If smoke, odors or noises are emitting from the unit, disconnect the AC power cord immediately.

PLACEMENT

Avoid placing the unit in surroundings with:

- Direct sunlight or heat sources, like radiators or ovens.
- High temperature (over 40 C) or high humidity (over 90%).
- Excessive dust.
- Electro-static effect.
- Vibration, impact, or tilted surface.

Otherwise the internal parts may be damaged.

NON-USE PERIODS

- Turn off the power when the unit is not used.
- The power cord should be unplugged from the AC outlet when the unit is idle for a long period of time.

DVD PLAYER

- Because of high voltage inside the unit, touching internal parts is dangerous and may lead to serious damage to the unit and even personal injury.
- DO NOT attempt to disassemble this unit under any circumstance.
- Only put a DVD or CD into the slot.

STACKING

Place the unit in a horizontal place, and DO NOT lay anything heavy on it.

CONDENSATION

Moisture may condense on the lens if placed in a steamy or very humid room or if moved from a cold environment to a warm one. If moisture appears inside this unit, it may not operate normally. In this case, unplug the power cord and wait for about 1 hour to let it dry.



CAUTION: DO NOT defeat the safety of the polarized or grounding-type plug. A polarized plug has two blades with one wider than the other. A grounding type plug has two plates and a third grounding prong. The wide blade or the third prong is provided for your safety. If the plug does not fit into your outlet, consult an electrician.

RAIN AND MOISTURE



WARNING: To avoid the hazards of fire or electrical shock, DO NOT expose this TV to rain or moisture.

INSTALLATION

DO NOT block any ventilation openings. DO NOT install near any heat source such as radiators, heat registers, stoves, or other apparatus that produce heat.

WET LOCATION

The TV SHOULD NOT be exposed to dripping or splashing. Objects filled with liquids, such as vases, SHOULD NOT be placed on the TV.

OXYGEN ENVIRONMENT



WARNING: DO NOT use in an oxygen tent or an oxygen chamber. Such use may cause a fire hazard.

CLEANING AND DISINFECTION

Clean the exterior of this TV by removing dust with a lint-free cloth.



CAUTION: DO NOT use abrasive or chemical cleaning agents. Clean only with a dry cloth.

PRODUCT MODIFICATION

DO NOT attempt to modify this product in any way without written authorization. Unauthorized modification could void the user's authority to operate this product.

OVERHEAD FALLING HAZARD



WARNING: To prevent injury, this apparatus must be securely attached to the wall in accordance with the installation instructions. TVs can pose a striking hazard when mounted at an elevated position.

OTHER EQUIPMENT

Use only with the cart, stand, tripod, bracket or table specified by the manufacturer or sold with the TV. Use caution when moving the cart.



WARNING: To reduce the chance of fire or electric shock, only utilize the accessories recommended by the manufacturer.

FCC, Copyright, Disclaimer, and Trademarks

FCC

This equipment has been tested and found to comply with the limits for a Class B digital device, pursuant to part 15 of the FCC Rules. These limits are designed to provide reasonable protection against harmful interference when the equipment is operated in a residential or commercial installation. If this equipment does cause harmful interference to radio or TV reception, which can be determined by turning the equipment off and on, the user is encouraged to try to correct the interference by one of more of the following measures:

- Reorient or relocate the receiving antenna.
- Increase the separation between the equipment and receiver.
- Connect the equipment to an outlet on a circuit different from that to which the receiver is connected.
- Consult the dealer or an experienced radio/TV technician for help.

Copyright

PDI Communication Systems, Inc. claims proprietary right to the material disclosed in this user manual. This manual is issued for user information only and may not be used to manufacture anything shown herein. Copyright 2009 by PDI Communication Systems, Inc. All rights reserved.

Disclaimer

The author and publisher have used their best efforts in preparing this manual. PDI Communication Systems, Inc. makes no representation or warranties with respect to the accuracy or completeness of the contents of this manual and specifically disclaim any implied warranties or merchantability or fitness for any particular purpose and shall in no event be liable for any loss of profit or any other damages. The information contained herein is believed to be accurate, but is not warranted, and is subject to change without notice or obligation.

Trademarks

Manufactured under license from Dolby Laboratories. Dolby and the double-D symbol are trademarks of Dolby Laboratories.

All other brand names and product names used in this manual are trademarks, registered trademarks, or trade names of their respective holder. PDI and Better Solutions Are Within Reach are registered trademarks of PDI Communication Systems, Inc., Springboro, Ohio.

Table of Contents

WARNINGS 2

SAFETY INSTRUCTIONS 2

Copyright, Disclaimer, & Trademarks 4

Wall Mounting with PD168-005 Standard Wall Bracket 7

Connections 8

 Across Room Wiring..... 9

 Antenna Connection..... 11

 AC Power 11

 Cable Routing..... 11

Product Accessories..... 12

Buttons on TV..... 12

Programming Remote Control 12

Patient Remote Control..... 13

Programming 14

 Service Levels 15

 Picture 16

 Brightness, Contrast, Color, Tint, and Sharpness 16

 Color Temperature 17

 Noise Reduction 17

 Sound 18

 Minimum Volume..... 18

 Maximum Volume..... 18

 Power on Volume 18

 Internal Speaker Enabled 19

 HDMI Audio Port 19

 Channels 20

 Signal 20

 Auto Program 21

 Add/Delete Channels 22

 Clear Service Level 23

 Copy Service Level 24

 Parental Control 24

 TV Rating 25

 TV Parental Guideline Rating System..... 25

 The sub-rating of TV rating 25

 MPAA Rating..... 26

 Motion Picture Association of USA (MPAA) Rating System 26

 Change Password 27

 Aux. Block Source 27

 Parental Lock Duration..... 27

 Parental Lock 27

 Power on Channel..... 28

 Channel Memory Override 29

 Channel Lock 29

 Features 29

 Power On Caption Mode..... 29

 Auto Power On/Lock 29

 Inactive Power Off (h:mm) 30

 Bed A/B 30

 Caption Text Modes 30

 Digital Captions 31

 Digital Mode Time Setup..... 32

 Diagnostics..... 33

 Channel Up Power Off 33

 Channel to Other Source 33

 Power On ARC Mode..... 34

 On Screen Menu Language Selection 34

 Sources 34

 Power On Source..... 34

 FM Radio..... 35

 Auto Program 35

 Add/Delete Stations 35

Cloning 36

 Save Settings to SD Card 36

Restore Setting to TV	37
Information	38
Firmware	38
DVD Module Operation	40
DVD Module installation	40
Enable DVD Module	40
DVD Playback	41
Basic Controls	41
Navigating menus	41
Advanced DVD playback features	41
Repeating a Chapter or Title	41
Changing the Subtitle and Audio	41
DVD Content Information	42
Setup menu	43
CD Playback	45
Basic Controls	45
Advanced CD playback features	45
Setting a track or whole CD to loop	45
Skipping to a certain place on a CD	45
Adjusting Audio output	45
Viewing JPG photos on a USB drive, SD card, or CD	46
Access USB/SD Card	46
Access Photo CD	46
View JPEG	46
Control slide show	46
Selecting thumbnail photos	46
Selecting more thumbnails	46
Other thumbnail screen controls	46
Limited Warranty	47

WALL Mounting With PD168-005 Standard Wall Bracket (Not supplied with TV)

1. Refer to Figure 1. Select a location on the wall approximately 5 inches below the ceiling.
NOTE: DO NOT locate AC, Across-Room Wiring, and CATV Signal outlets below the Wall Bracket's location as it will cause clearance issues and interfere with the TV's cabinet when mounted to the bracket.
Position the Wall Bracket and locate two mounting holes. Secure the bracket to the wall (mounting hardware is not included).
2. Refer to Figure 2. The TV can be mounted with 4 mm hardware (not provided) using a compatible mount. Position the Back Mount on the LCD TV cabinet. Attach with four M4 x 6mm screws provided with the mount.
3. Mate the Back Mount to the Wall Bracket making sure the pivot pins are retained in the "U" shaped slot. Using the pilfer security driver packed with the hardware, secure with two 10x32 pilfer screws.
4. Connect the AC power cord, Pillow Speaker Jumper Cable, and CATV Coax Cable.
5. The TV's tilt can be adjusted by loosening both Pilfer Screws, adjusting tilt, and then tightening the screws.

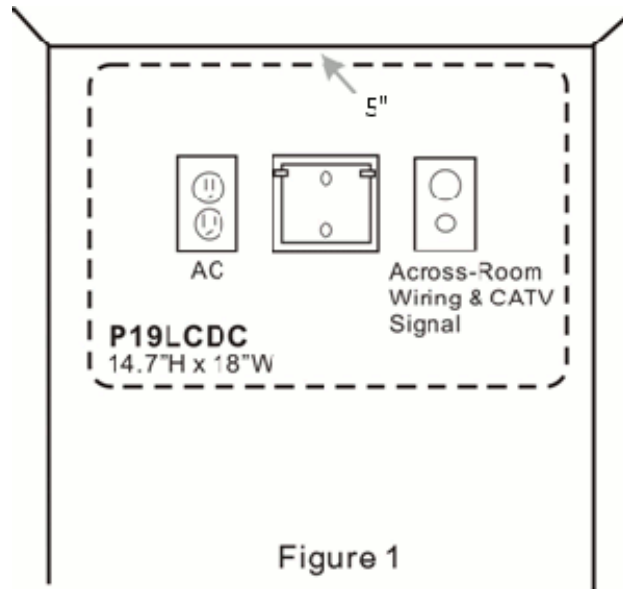
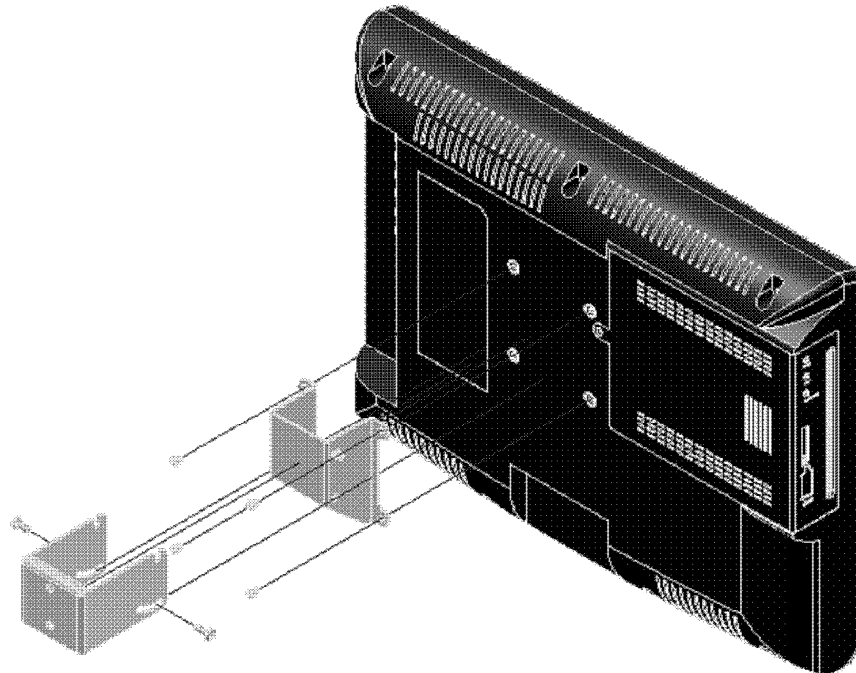
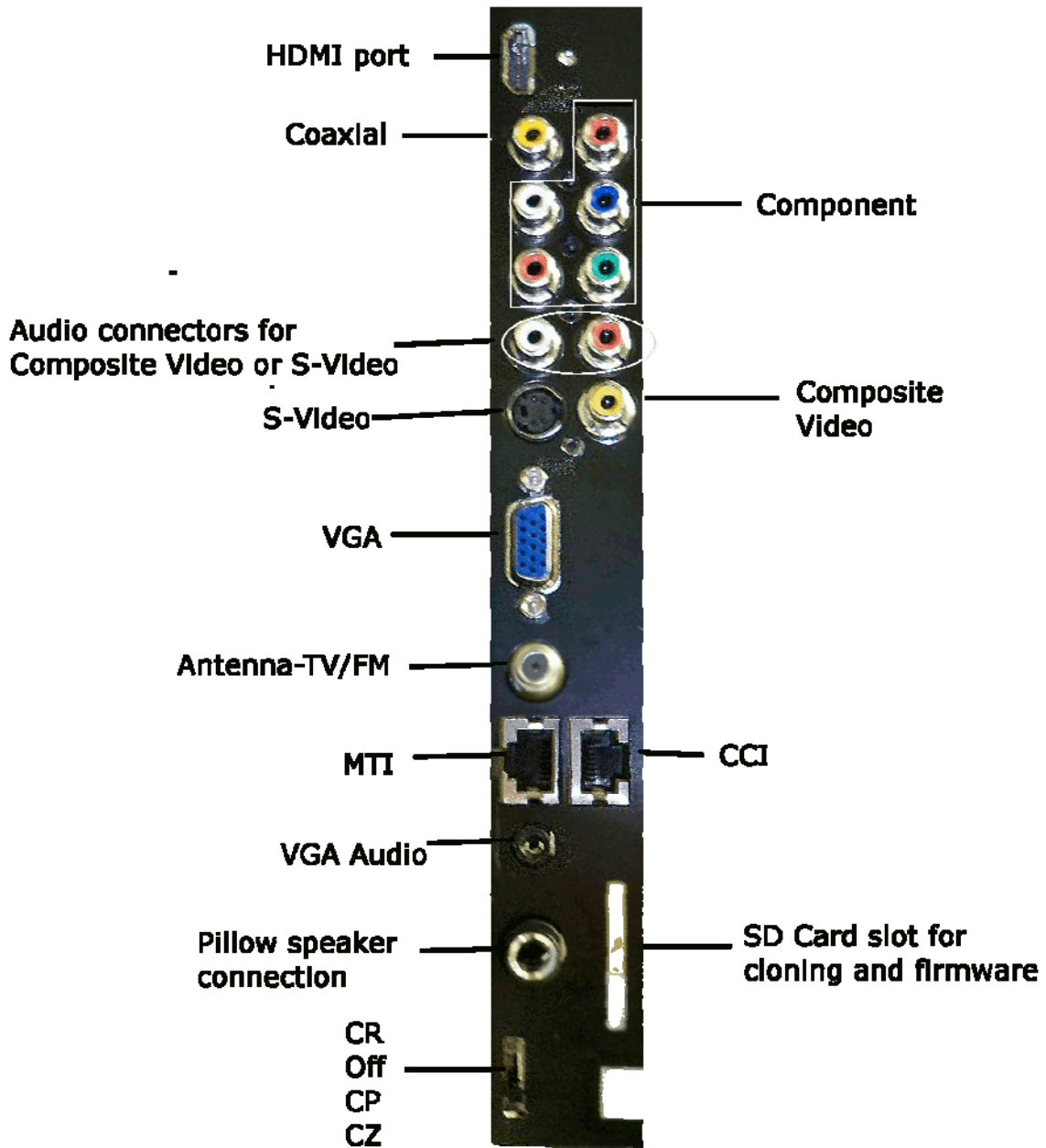

Figure 2



Connections



Across Room Wiring

A ¼" stereo style pillow speaker (pendant control) jack is located on the TV's connections panel.

This TV is designed to work with either a digital pillow speaker that generates digital style control codes or a single-button analog (switch-style) pillow speaker. A rear panel mounted switch allows use of different brands of pillow speakers: Zenith, Philips, and RCA compatible pillow speakers.



CAUTION: Confirm the pillow speaker type and set the side switch appropriately BEFORE connecting the pillow speaker to the TV. Failure to follow this procedure could result in damage to the pillow speaker and/or TV.

1. Select the appropriate brand of digital pillow speaker using the recess slide switch below the PILLOW jack.
CZ for Zenith®
CP for Philips®
CR for RCA®
OFF to disable the pillow speaker.
2. Connect the pillow speaker to the PILLOW jack.
3. Operate the pillow speaker.

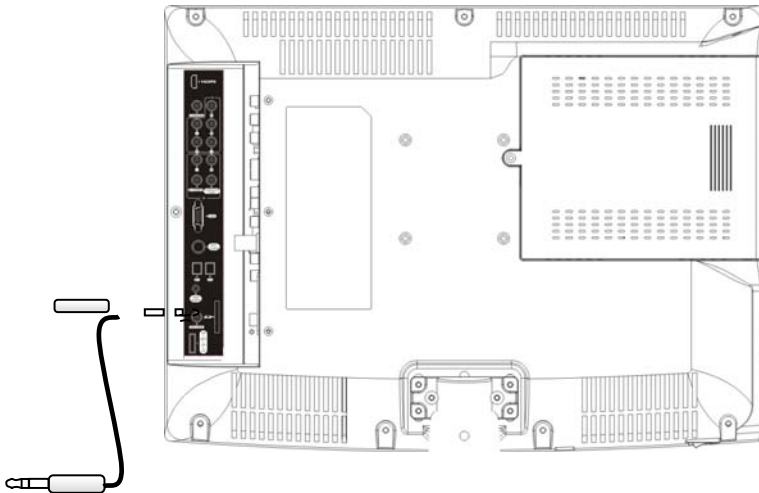



WARNING: DO NOT connect the pillow speaker circuit Common to earth ground. Grounding of the Common will defeat the isolation circuitry of the TV and possibly expose the patient to harmful shock currents should a wiring fault occur.

NOTE: A Jumper Cable is NOT supplied with the TV and must be ordered separately.

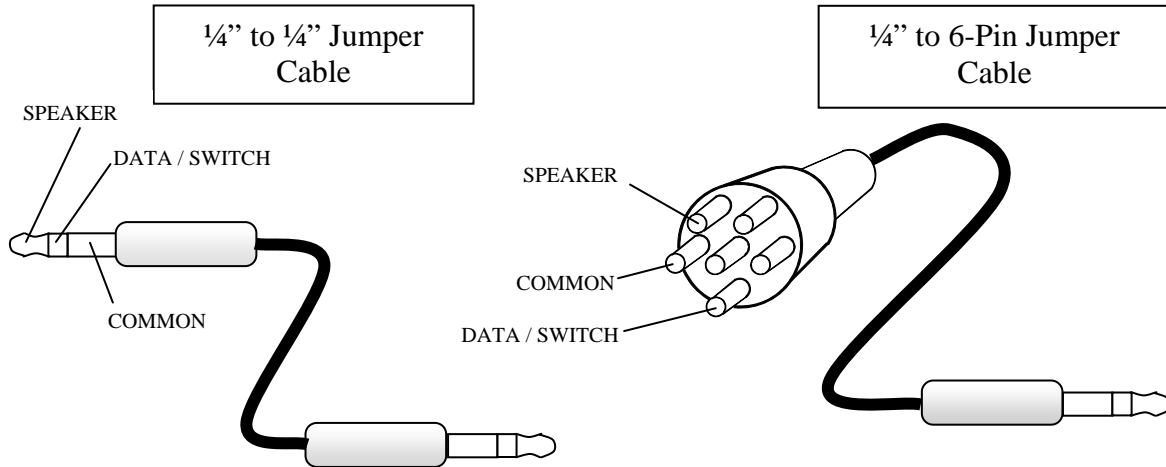

To Wall Plate
Pillow Speaker Connection

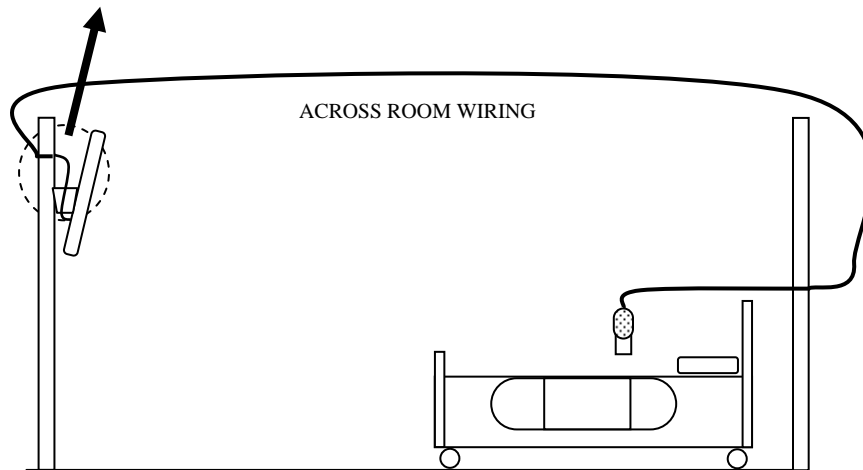

Antenna Connection

An "F" style jack is located on the TV's connector panel.



CAUTION: Some hospital cable systems provide power voltage on the coaxial cable. This TV is **NOT** designed to be powered via a coaxial cable. **DO NOT** connect to a powered coaxial cable. Damage will result to the TV.

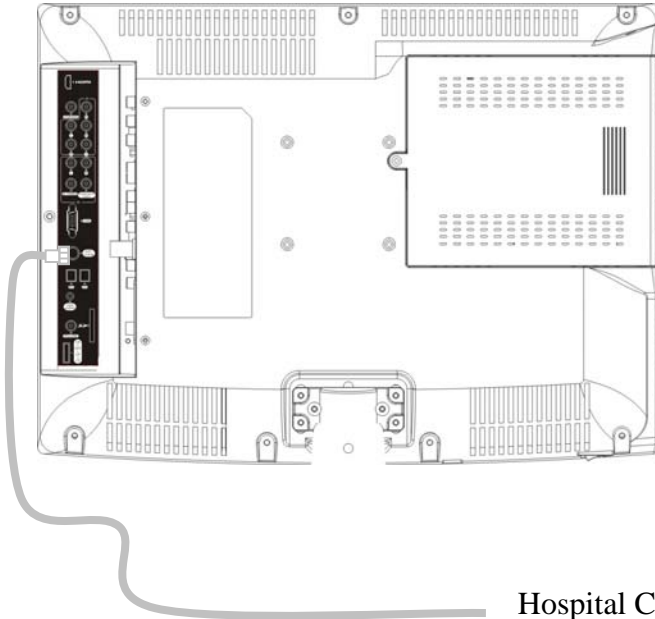

Hospital Coax Cable

AC Power

A right-angled AC power cord is attached to each TV.

Connect the AC power cord to a powered outlet.

Cable Routing

Route all cables through the opening located at the bottom of the cabinet.

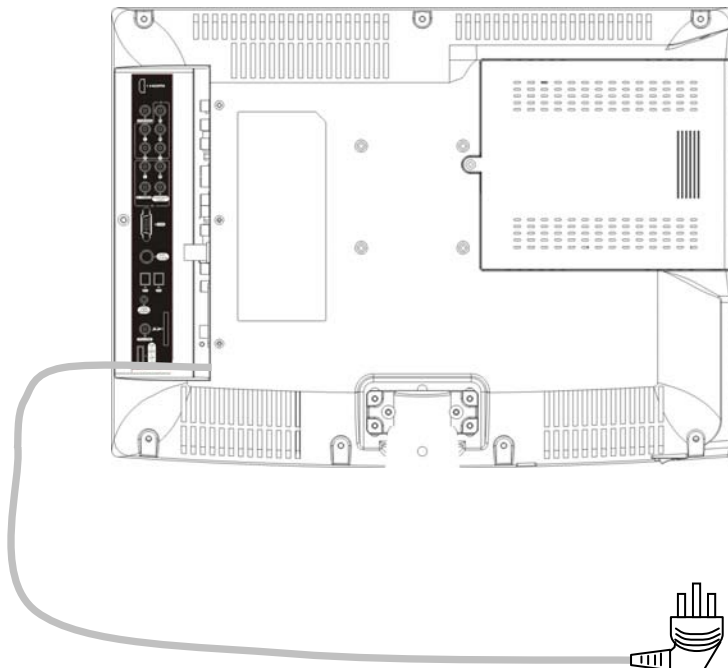

Product Accessories (Not Included with TV)

75mm VESA Wall Mount	PD168-005	Patient Remote Control (*For TV's without DVD module)	PD108-421
Programming Remote Control	PD108-420	¼" to 6-Pin Jumper Cable	PD106-416
Patient Remote Control (*Remote comes with DVD module)	PD108-427	¼" to ¼" Jumper Cable	PD106-417

Buttons on TV

There are buttons on the left side of the P19 that allow basic operation of the TV.

- Power
- CH ▲
- CH ▼
- VOL▲
- VOL▼
- CC – Closed Caption
- TV/AV

Programming Remote Control

The P19 requires a programming remote control, part number PD108-420, to program it. You will NOT find a remote control packed with the TV. The remote control is an option and would ship separate from the TV.

The remote control has a limited range to prevent dual programming of an adjacent room TV. Stand within 3 feet of the front of the TV to use the remote control.

NOTE: Before you use the remote control, please install the batteries.



Patient Remote Control - PD108-427

This remote can be used by patients to control the TV and DVD Module

NOTE: Before you use the remote control, please install the batteries.

-
1. **POWER button**
Turns the TV on or off.
 2. **▶PLAY button**
Starts to play the disc in DVD mode.
 3. **⏸ PAUSE button**
Pause the playback or start step by step playback in DVD mode.
 4. **◀ button**
Activates fast backward playback during disc playback in DVD mode.
 5. **▶▶ button**
Activates fast forward playback during disc playback in DVD mode.
 6. **0-9 Number buttons**
Selects numbers.
 7. **LAST button**
Returns to the previously viewed channel.
 8. **MUTE button**
Turns the sound on or off.
 9. **VOL +/- button**
Adjusts the sound level or adjusts menu settings.
 10. **MTS/SAP button**
Adjust the audio mode for **SAP**, **Mono**, or **Stereo**.
 11. **TV/AV button**
Selects enabled external inputs.
 12. **Direction buttons (▲▼◀▶)**
Selects a menu item or adjusts menu settings.
 13. **OK button**
Confirms the current selection.
 14. **SLEEP button**
Sets the sleep timer.
 15. **SETUP button**
Displays the main menu. Exit current OSD menu.
 16. **MENU button**
Displays the disc menu in DVD.
 17. **SUBTITLE button**
Selects a desired subtitle language if the disc contains multi-subtitle languages during disc playback in DVD mode.
 18. **CODE button**
The remote offers independent Bed A or Bed B selectable codes and independent control of a single TV in a two TV room.
 19. **AUDIO button**
Selects a desired audio language if the disc contains multi-audio languages during disc playback in DVD mode.
 20. **EJECT button**
Ejects the disc in DVD mode.
 21. **▶▶▶ button**
Press to go to the next chapter/track during disc playback.
 22. **◀◀◀ button**
During disc playback, press once to go to the beginning of current chapter/track; press twice to go to the previous chapter/track.
 23. **+10 button**
In TV mode, press to select DTV (Digital TV) channels. For example, to select channel '54-3', press this button and '3'. In DVD mode, press to select numbers greater than 9.
 24. **PSM button**
Recalls your preferred picture setting.
 25. **CH +/- button**
Selects next channel or a menu item.
 26. **CCD button**
Sets the caption function.
 27. **ARC button**
Changes the aspect ratio. Repeatedly press the ARC button to select your desired picture format.
 28. **TV/FM button**
Selects either TV or FM mode.
 29. **REPEAT button**
Press to repeat a chapter or title in DVD mode.
 30. **TITLE button**
Press to enter or exit the title menu of the disc during disc playback in DVD mode.
 31. **CARD button**
In DVD mode, press to shift among disc, USB and CARD playback mode when an external USB device or card is connected.
 32. **GOTO button**
Press to access or exit the DVD search menu.

Programming

The P19 is programmed by a series of menus that can be accessed with a remote, part number PD108-420. Access the menus by pressing SETUP on the remote. These menus allow you to add TV channels, adjust the picture and sound, setup external components, and change other settings.



The SETUP menu is the first menu that appears. All the other menus and all the settings can be accessed through it. This manual explains and shows how to setup the different features of the P19.

Service Levels

The P19 contains four separate Service Levels, allowing the hospital to offer either basic or enhanced viewing. The current Service Level can be quickly determined by accessing the SETUP menu using the remote control. The Service Level can be changed to any of the 4 levels at any time by entering the SETUP menu and changing the Service Level menu items.



DISABLED – This is like a mechanical key lock. When in *Disabled* Service Level, the TV can be turned off and on, but it cannot be used for viewing. A standard message appears on a black screen.

FREE – This lets patients watch hospital education and information channels without renting the TV. The channels containing programming for no charge are typically programmed into this level of service. This is the factory default setting for Service Level.

BASIC – This service typically allows additional channels beyond those offered in the FREE level.

PREMIUM – This is the highest service level with typically the most channels available for viewing.

Picture

This menu allows you to make changes to settings that will change the picture's appearance.

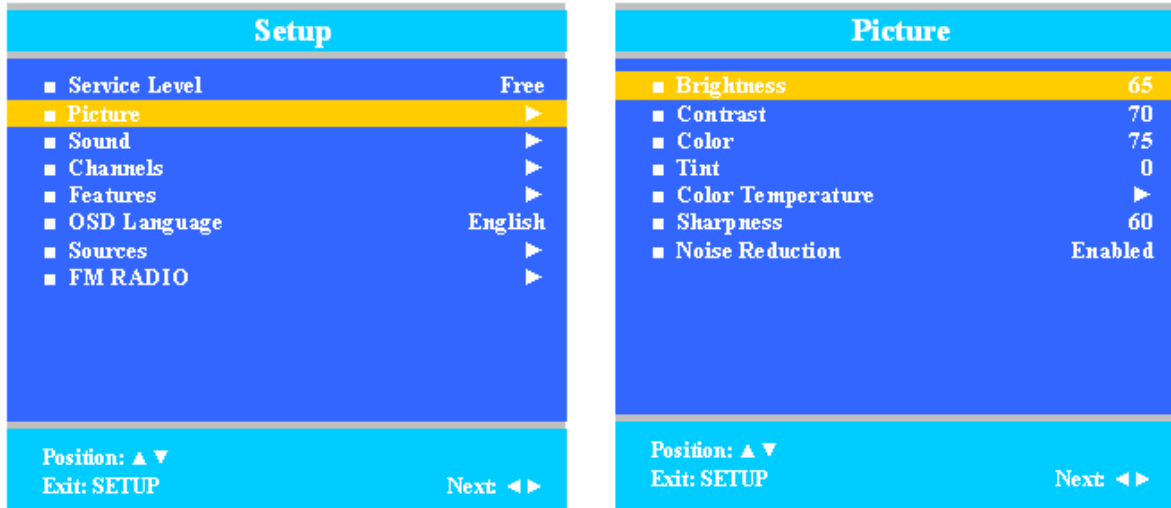

1. Press the SETUP button on the remote control.
2. Press ▲ or ▼ to highlight Picture.
3. Press ► to enter the Picture sub-menu.

Brightness, Contrast, Color, Tint, and Sharpness

These settings have a range of 1-100. To change one of them, change the number by following this process.

1. Enter the Picture menu
2. Press ▲ or ▼ to highlight the setting you want to change.
3. Press ◀ or ▶ to the desired number.
4. Press SETUP to return to the previous menu. To exit, press SETUP until the programming menus disappear.

Color Temperature

Color Temperature adjusts the color balance of the picture. Standard, Reddish, Greenish, and Bluish are preset adjustments. You can customize the color temperature with the User setting.

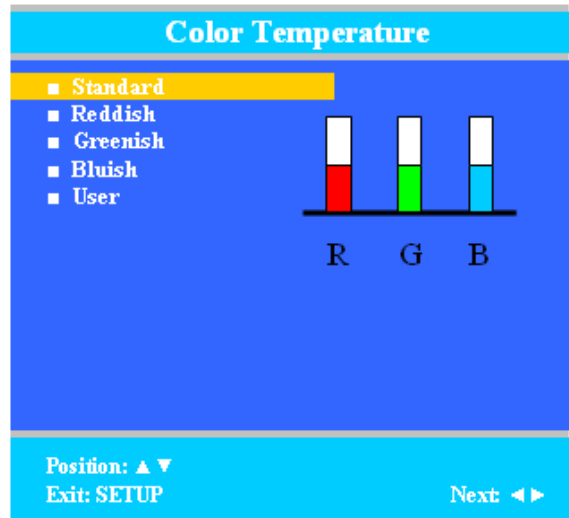
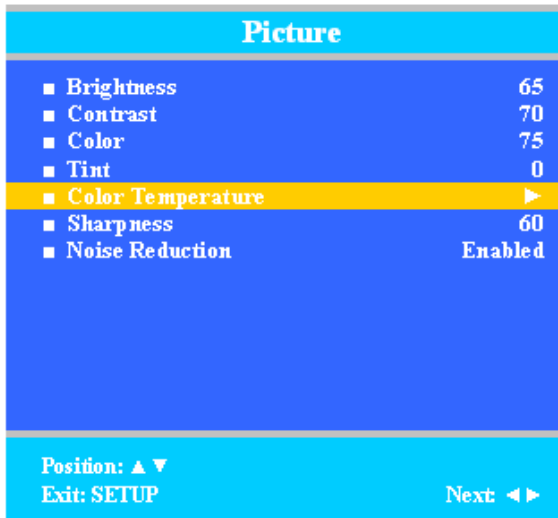

1. Enter the Picture menu
2. Press ▲ or ▼ to highlight Color Temperature.
3. Access the menu by pressing ►.
4. Press ▲ or ▼ to highlight and select one of the five settings.
5. For User, press ◀ and ▶ to select R, G, or B or to get out of the customized adjustments.
6. Press ▲ or ▼ to adjust R,G, or B

NOTE: When you select one of the three colors to adjust, the other two turn grey.

7. Press SETUP to return to the previous menu. To exit, press SETUP until the programming menus disappear.

Noise Reduction

Additional picture improvement may be reached by enabling Noise Reduction.



1. Enter the Picture menu
2. Press ▲ or ▼ to highlight Noise Reduction.
3. Press ◀ or ▶ to select Enabled or Disabled.
4. Press SETUP to return to the previous menu. To exit, press SETUP until the programming menus disappear.

Sound

The sound menu allows precise adjustment of several sound parameters.

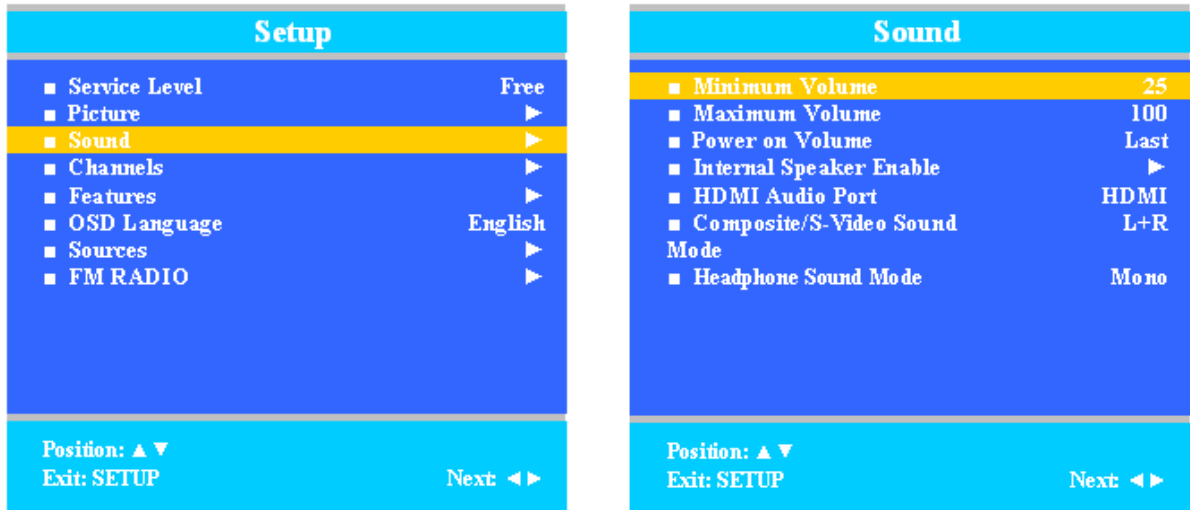

1. Press the SETUP button on the remote control.
2. Press ▲ or ▼ on to highlight Sound.
3. Press ▶ to enter the Sound sub-menu.

Minimum Volume

Sets the minimum volume level the TV can reach. Setting this to any value other than 0 guarantees that some level of sound will always be heard when the TV is operating.

1. Enter the Sound menu.
2. Press ▲ or ▼ to highlight Minimum Volume.
3. Press ◀ or ▶ to select the desired number (0-100).
4. Press SETUP to return to the previous menu. To exit, press SETUP until the programming menus disappear.

Maximum Volume

Sets the maximum volume level the TV is allowed to reach.

1. Enter the Sound menu
2. Press ▲ or ▼ to highlight Maximum Volume.
3. Press ◀ or ▶ to select the desired number (0-100).
4. Press SETUP to return to the previous menu. To exit, press SETUP until the programming menus disappear.

Power on Volume

Sets the initial volume for when the TV is turned on.

NOTE: If Power on Volume is set to Last and the physical power is removed, the TV will power on with a volume of zero.

1. Enter the Sound menu
2. Press ▲ or ▼ to highlight Power on Volume.
3. Press ◀ or ▶ to select the desired number (0-100) or Last.
NOTE: Last will cause the TV to be at the last setting before it was turned off.
4. Press SETUP to return to the previous menu. To exit, press SETUP until the programming menus disappear.

Internal Speaker Enabled

This allows audio for different sources to be enabled. Sound also is routed externally to the attached pillow speaker.

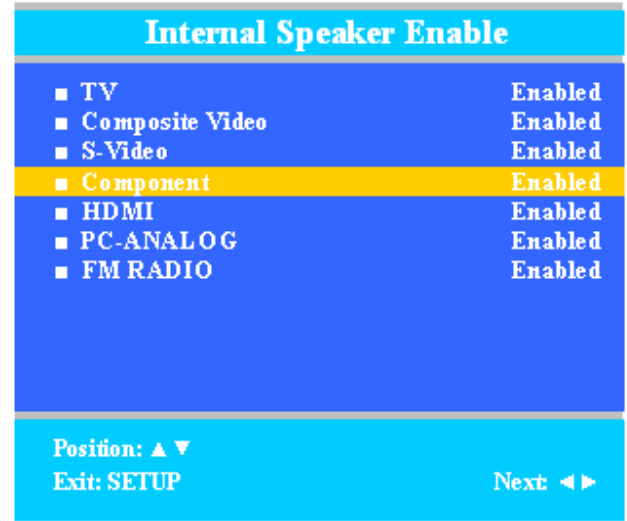
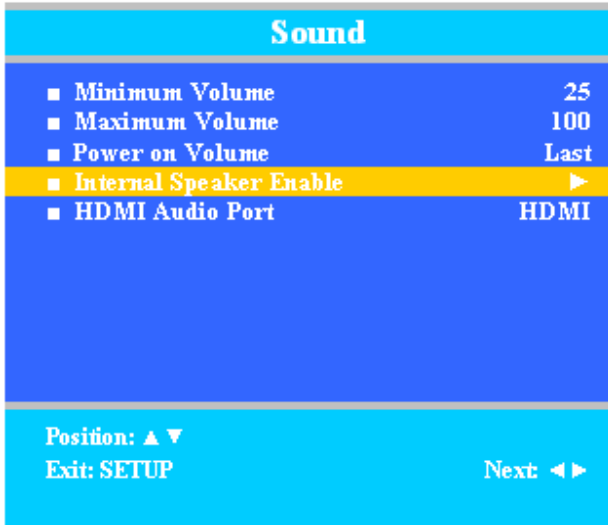

1. Enter the Sound menu
2. Press ▲ or ▼ to highlight the component you want to change.
3. Press ◀ or ▶ to select Enabled or Disabled.
4. Press SETUP to return to the previous menu. To exit, press SETUP until the programming menus disappear.

HDMI Audio Port

Sound can be set to come from one of several other sources when the TV is set to HDMI video. The HDMI Audio Port has three settings: HDMI, PC, and Component.

1. Enter the Sound menu
2. Press ▲ or ▼ to highlight HDMI Audio Port.
3. Press ◀ or ▶ to select HDMI, PC, or Component
4. Press SETUP to return to the previous menu. To exit, press SETUP until the programming menus disappear.

Channels

The Channels menu allows you to program different signal sources into three Service Levels (Free, Basic, or Premium) and to add or delete individual channels. It also allows you to block channels, TV programs, movies, and auxiliary sources that can be input to the TV. Each Service Level contains a different channel map.

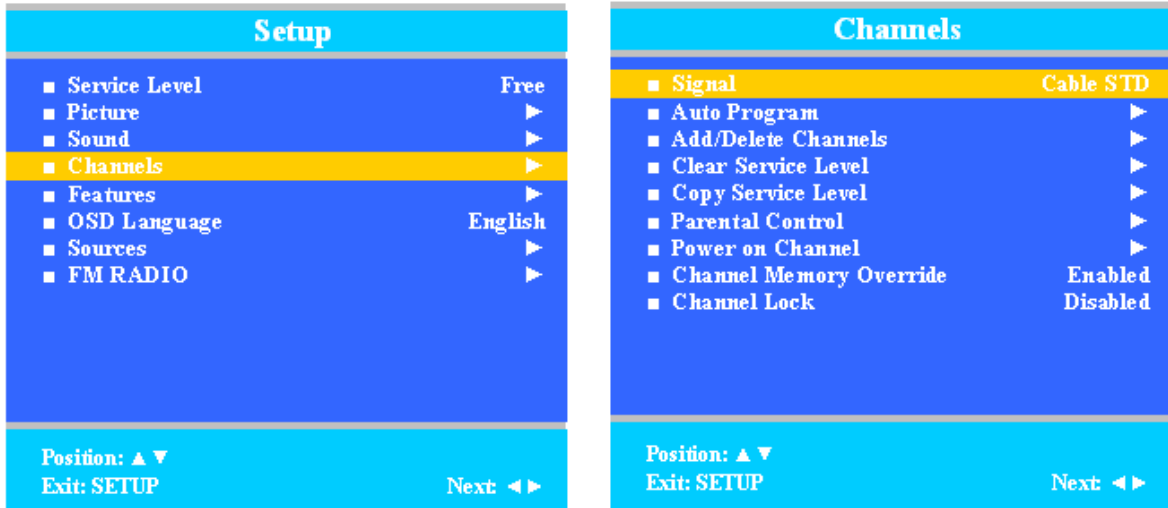

1. Press the SETUP button on the remote control.
2. Press ▲ or ▼ to highlight Channels.
3. Press ► to enter the Channels sub-menu.

Signal

Four different tuning types are available depending upon the healthcare facility's signal type. Selection of the correct signal type is required for the TV to recognize all possible channels and before any channel programming can begin.

1. Enter the Channels menu
2. Press ▲ or ▼ to highlight Signal.
3. Press ◀ or ▶ to select Air, Cable STD, Cable IRC, or Cable HRC.
NOTE: Most hospitals use the Cable STD signal style.
4. Now perform Auto Program or Add/Delete Channels to adjust the channels.

Auto Program

The TV automatically scans each available channel for activity. Channels that display activity are memorized into the selected Service Level.

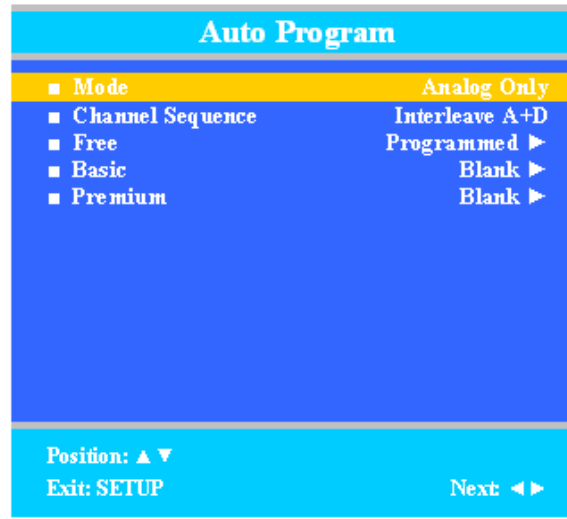
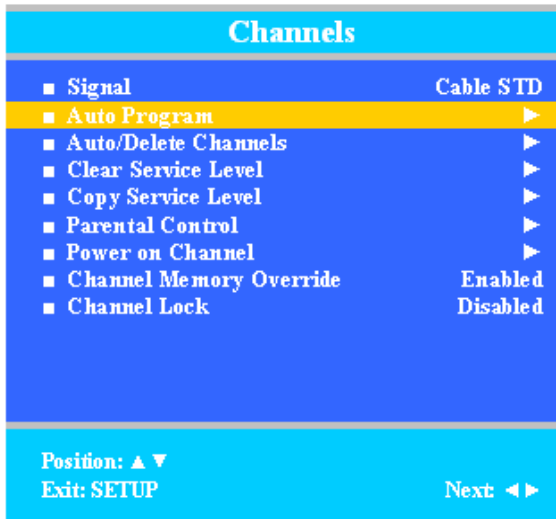

1. After setting Signal, press ▲ or ▼ to highlight Auto Program.
2. Press ▶ to select it.
3. On Mode, press ◀ or ▶ to select the scope of channel scanning.
 - Analog Only: TV searches for analog channels only.
 - Digital Only: TV searched for digital channels only.
 - Analog and Digital: TV searches for both analog and digital channels.
4. Press ▲ or ▼ to highlight Channel Sequence.
5. Press ◀ or ▶ to select the Channel Sequence in which the channels are displayed.
 - Interleave A+D: Channels are displayed in the order of channel number.
 - All A then D: All digital channels are displayed after all analog channels.
6. Press ▲ or ▼ to highlight the Service Level (Free, Basic, or Premium) you wish to program. The menu displays the current programming status of each level as either Programmed or Blank.

NOTE: A programmed service level also can be reprogrammed if desired.
7. Press ▶ to start auto programming.
8. A confirmation menu will appear before proceeding. Press ▲ to start auto programming. Press ▼ to cancel the operation. The TV now will search all available channels. Auto programming requires several minutes to complete.

NOTE: Digital channel auto programming may take longer than 10 minutes to complete.
9. Press the SETUP button to return to normal TV viewing.

Add/Delete Channels

Individual analog TV channels that are missing can be manually added to a Service Level. Analog channels that require deletion can be manually removed from a Service Level. Digital channels found during auto programming can be enabled or disabled in each Service Level.

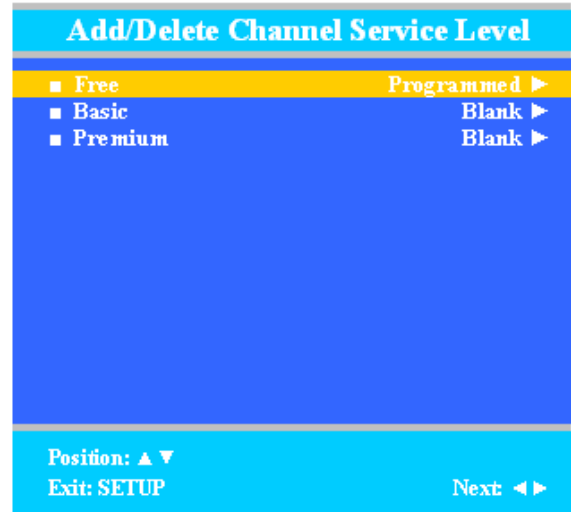
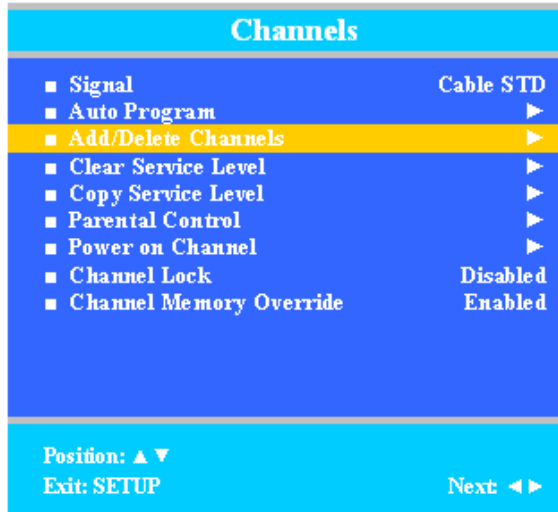

1. Enter the Channels menu
2. Press ▲ or ▼ to highlight Add/Delete Channels.
3. Press ► to select it.
4. Press ▲ or ▼ to highlight the Service Level (Free, Basic, or Premium).
5. Press ► to select the highlighted Service Level.
6. If you want to add or delete an analog channel, press ◀ or ▶ to select the desired analog channel. If you want to enable or disable digital channels, go to step 10.

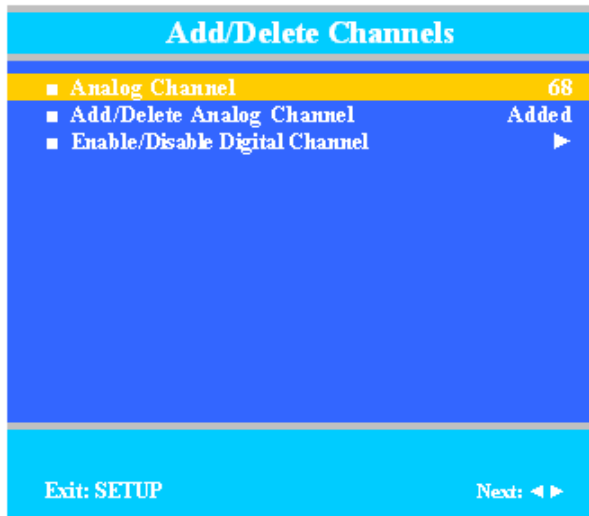

7. After you have selected the desired analog channel, press ▲ or ▼ to highlight Add/Delete Analog Channel.
8. Press ◀ or ▶ to select Added or Deleted.
9. If you are done, Press SETUP to return to the previous menu. To exit, press SETUP until the programming menus disappear. If there are more analog channels to be added or deleted, repeat steps 6 through 8. For enabling or disabling digital channels, go to the next step.
10. Press ▲ or ▼ to highlight Enable/Disable Digital Channel.
11. Press ► to select Enable/Disable Digital Channel.
NOTE: If there are not any channels programmed in the Service Level, "No Channels Present" will appear in the menu.
12. Press ▲ or ▼ to highlight the digital channel that needs to be enabled or disabled.

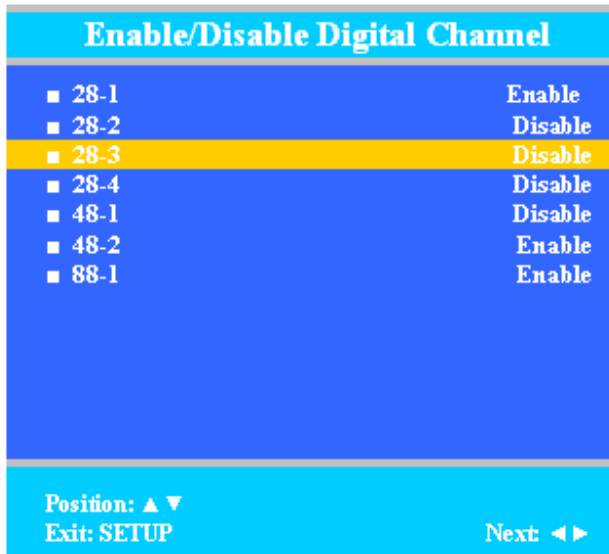

- Press ◀ or ▶ to select Enable or Disable.
- Press the SETUP button to return to the previous menu.

Clear Service Level

This empties a service level of all its programmed channels, leaving it blank.

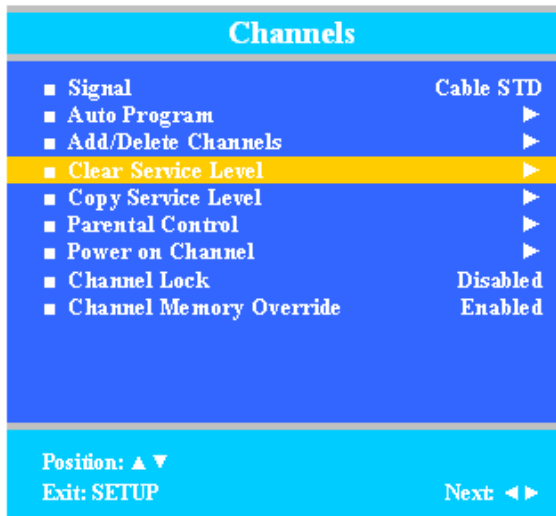

- Enter the Channels menu
- Press ▲ or ▼ to highlight Clear Service Level.
- Press ▶ to select it.
- Press ▲ or ▼ to highlight the Service Level (Free, Basic, or Premium).
- Press ▶ to select the highlighted Service Level.
- A confirmation page will appear. Press ▲ to proceed. Press ▼ or SETUP to return to the previous menu.
NOTE: After a Service Level is cleared, the TV returns to the Clear Service Level menu. "Blank" will appear to the right of the Service Level.
- Press SETUP to return to the previous menu. To exit, press SETUP until the programming menus disappear.

Copy Service Level

This copies one Service Level's channels to another.

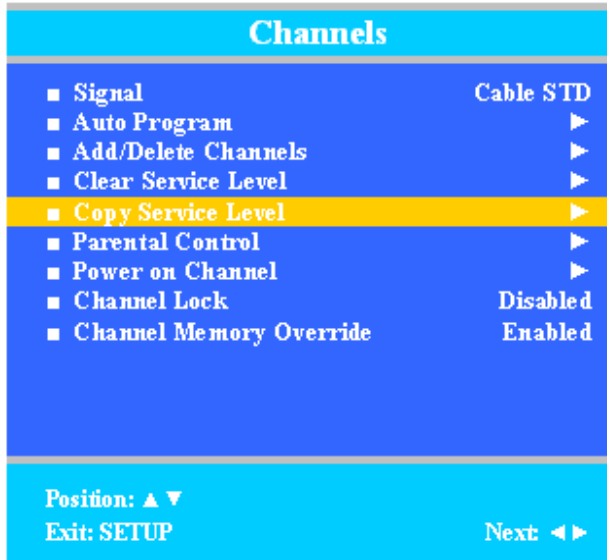

1. Enter the Channels menu
2. Press ▲ or ▼ to highlight Copy Service Level.
3. Press ▶ to select it.
4. Press ▲ to set the From Service Level. Press ▼ to set the To Service Level.
5. Press ▶ to copy the Service Level.
6. A confirmation page will appear. Press ▲ to proceed. Press ▼ or SETUP to return to the previous menu.
NOTE: After a Service Level is copied, the TV returns to the Copy Service Level menu. If the To Service Level has been set to active in the Service Level setting (see Service Levels on page 14) , TV programming will appear.
7. Press SETUP to return to the previous menu. To exit, press SETUP until the programming menus disappear.

Parental Control

Parental Control allows you to block channels, TV shows, movies, and devices that are connected to the P19.

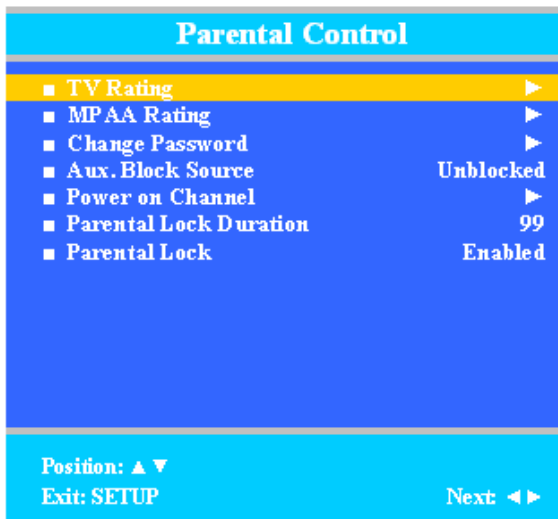

1. Enter the Channels menu
2. Press ▲ or ▼ to highlight Parental Control.
3. Press ▶ to select it.

TV Rating

Most TV programs are now rated. TV Rating allows the TV to selectively present only programming content that is unblocked per its preset level. A program that is blocked, displays a black screen only.

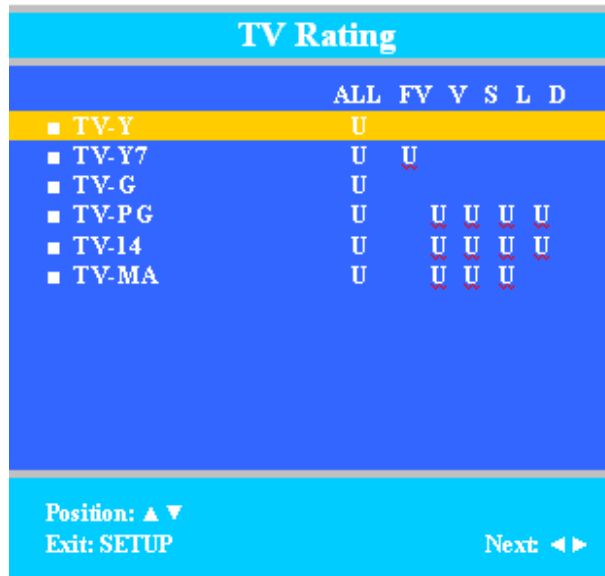

1. From the Parental Control menu, enter the TV Rating menu.
2. Press ▲ or ▼ to move to one of the six age-based categories.
3. Press ◀ or ▶ to cycle through the sub-ratings (ALL, FV, V, S, L or D) or exit out of the sub-categories in that category.
NOTE: The U or B (unblocked or blocked) will turn red when it is highlighted
4. Press ▲ or ▼ to change the sub-rating.
5. Press the SETUP button to return to the previous menu. Or press ◀ to get out of the sub-category.
NOTE: Categories that are rated for older audiences will be automatically blocked. If you block TV-Y category, then TV-Y7 will be blocked automatically. Similarly, if you block TV-G category, then TV-PG, TV-14 and TV-MA will also be blocked.

TV Parental Guideline Rating System

Grade		Meaning
TV-Y	Young Children	Content not offensive to most viewers
TV-Y7	Children 7 and over	Considered suitable for children over 7, may contain Fantasy Violence Scenes.
TV-G	Parental Audience	Considered suitable for all audiences; children may watch unattended.
TV-PG	Parental Guidance	Suggested Unsuitable for younger children, may contain: Suggestive Dialog, Bad Language, Sex, and Violence Scenes
TV-14	Parents Strongly Cautioned	Unsuitable for children under 14, may contain: Strong Dialog, Bad Language, Sex, and Violence Scenes.
TV-MA	Mature Audience Only	Adults only, may contain: Strong Dialog, Bad Language, Sex, and Violence Scenes.

The sub-rating of TV rating

Grade	Meaning
FV	Fantasy Violence
V	Violence
S	Sexual Situation
L	Adult Language
D	Sexual Suggestive Dialog

MPAA Rating

Most televised movies are now rated. MPAA Rating selectively allows the TV to only present movie content that is unblocked per its preset level.

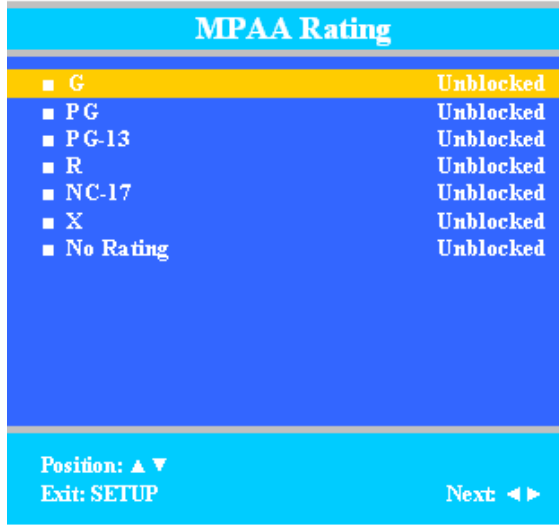

1. From the Parental Control menu, enter the MPAA Rating menu.
2. Press ▲ or ▼ to highlight a particular MPAA Rating.
3. Press ◀ or ▶ to select Blocked or Unblocked.
NOTE: Parental Control will automatically block any category that is rated for older audiences. For example, if you block the PG-13 category, then R, NC-17 and X will be automatically blocked also.
4. Press SETUP to return to the previous menu. To exit, press SETUP until the programming menus disappear.

Motion Picture Association of USA (MPAA) Rating System

Grade		Meaning
G	General Audiences	Content not offensive to most viewers
PG	Parental Guidance Suggested	Content is such that parents may not want their children to view the program.
PG-13	Parental Strongly Cautioned	Program is inappropriate for preteens, with a greater degree of offensive material Suggested than a PG rated program
R	Restricted viewing	Not for children under age 17. Strong elements of sex and/or violence.
NC-17	No Children under age 17	Not for children under age 17 under any circumstances. Strong sexual content.
X	Hard Core Films	Same as NC-17 rating.
No Rating	No Rating	MPAA Not Rated

Change Password

The Parental Control access password can be changed using this menu.

NOTE: The factory default password that is programmed into the TV is 0000.

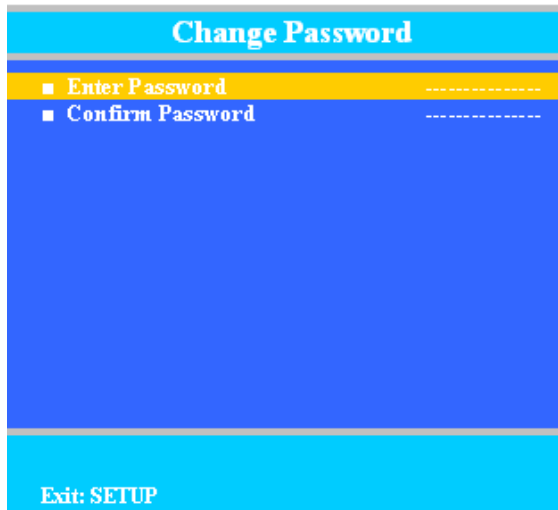

1. From the Parental Control menu, enter the Change Password menu.
2. Enter a new password by using the number buttons on the remote.
3. Confirm the password by entering the same digits.
NOTE: After confirming the password, the TV will return to the Parental Control menu.

Aux. Block Source

Like TV programs and channels, the auxiliary sources can be blocked too. When the TV encounters an external signal source that is not appropriate per its settings, a black screen appears with muted sound.

NOTE: Parental Lock must be enabled for the sources to be blocked.

1. In the Parental Control menu, press ▲ or ▼ to highlight Aux. Block Source.
2. Press ◀ or ▶ to select Unblocked or Blocked.
3. Press SETUP to return to the previous menu. To exit, press SETUP until the programming menus disappear.

Parental Lock Duration

This sets how long an enabled Parental Lock will be active.

1. In the Parental Control menu, press ▲ or ▼ to highlight Parental Lock Duration.
2. Press ◀ or ▶ to select the desired number of hours (1-99) or Always.
3. Press the SETUP button to return to the previous menu. To exit, press SETUP until the programming menus disappear.

Parental Lock

This enables or disables the settings in the Parental Control menu. Enabling it will require the password to be entered to access the Parental Control menu in the future.

1. In the Parental Control menu, press ▲ or ▼ to highlight Parental Lock.
2. Press ◀ or ▶ to select Enable or Disable.
3. Press the SETUP button to return to the previous menu. To exit, press SETUP until the programming menus disappear.

Power on Channel

Displays a certain channel each time the TV is turned on. This feature is useful for hospitals that have a Welcome Channel and wish to have it displayed upon initial use of the TV. The patient can then tune to any other available channel.



1. Enter the Channels menu
2. Press ▲ or ▼ to highlight Power on Channel.
3. Press ► to select it.
4. Press ▲ or ▼ to highlight the desired Service Level (Free, Basic, or Premium).
5. Press ◀ or ▶ to select one of the channels currently available in the Service Level or Last.
NOTE: Last will cause the TV to turn on to the last channel before it was turned off.
6. Press the SETUP button to return to the previous menu. To exit, press SETUP until the programming menus disappear.

Channel Lock

Locks the currently viewed channel and prevents patients from tuning to any other channel. This feature is useful when the TV is used for information display purposes.

1. Enter the Channels menu
2. Press ▲ or ▼ to highlight Channel Lock.
3. Press ◀ or ▶ to select Enable or Disable.
4. Press the SETUP button to return to the previous menu. To exit, press SETUP until the programming menus disappear.

Channel Memory Override

Allows a channel to be entered with the remote's number buttons that is not memorized in the current Service Level.

1. Enter the Channels menu
2. Press ▲ or ▼ to highlight Channel Memory Override.
3. Press ◀ or ▶ to select Enabled or Disabled.
 - DISABLED = Service Level Channels only.
 - ENABLED = All possible channels.
4. Press the SETUP button to return to the previous menu. To exit, press SETUP until the programming menus disappear.

Features

The Features menu provides adjustable settings that customize the TV to your hospital.



1. Press the SETUP button.
2. Press ▲ or ▼ to highlight Features.
3. Press ▶ to enter the Features sub-menu.

Power on Caption Mode

Power on Caption Mode memorizes the caption setting upon powering the TV off. With this feature set to off, the TV will always power on with the captions disabled. With this feature set to Last, the TV turns on with the last caption setting enabled.

1. Enter the Features menu
2. Press ▲ or ▼ to highlight Power on Caption Mode.
3. Press ◀ or ▶ to select Last or Off.
4. Press the SETUP button to return to the previous menu. To exit, press SETUP until the programming menus disappear.

Auto Power On/Lock

The TV will turn on and stay on whenever electrical power is applied to the set. The feature is useful for controlling the TV from a wall switch or preventing the TV from being turned off by the TV power button or the remote control.

1. Enter the Features menu
2. Press ▲ or ▼ to highlight Auto Power On.

3. Press ◀ or ▶ to select Disabled or Enabled.
4. Press the SETUP button to return to the previous menu.

Inactive Power Off (h:mm)

The TV will automatically power off after a specific period of viewer inactivity providing energy savings.

1. Enter the Features menu
2. Press ▲ or ▼ to highlight Power Management.
3. Press ◀ or ▶ to select an active time or select Disabled to disable this feature.
4. Press the SETUP button to return to the previous menu. To exit, press SETUP until the programming menus disappear.

NOTE: *Auto Power On must be set to Disabled for this function to operate.*

Bed A/B

The TV can be controlled by a patient IR remote. The TV offers Bed A and Bed B selectable codes for independent control of a single television in a two television room. The patient remote can be toggled between Bed A and Bed B codes by pressing (using a paperclip) the CODE button on the remote.

1. Enter the Features menu
2. Press ▲ or ▼ to highlight Bed A/B.
3. Press ◀ or ▶ to select A or B.
4. Press the SETUP button to return to the previous menu. To exit, press SETUP until the programming menus disappear.

Caption Text Modes

Teletext can be displayed in addition to Captions. Teletext is not normally broadcast in the USA. Caption Text Modes should be set to Disabled for TVs operated in the USA.

1. Enter the Features menu
2. Press ▲ or ▼ to highlight Caption Text Modes.
3. Press ◀ or ▶ to select Disabled or Enabled.
4. Press SETUP to return to the previous menu. To exit, press SETUP until the programming menus disappear.

Digital Captions

Customization of Closed Captions on ATSC/QAM channels.



1. Enter the Features menu
2. Press ▲ or ▼ to highlight Digital Captions.
3. Press ► to select it.
4. Press ▲ or ▼ to highlight the attribute you wish to change.
5. Press ► to change it. (See the table below for the settings of each attribute.)
6. Press SETUP to return to the previous menu. To exit, press SETUP until the programming menus disappear.

Attribute	Settings
Font Size	default, small, standard, large
Font Style	default, sizes 0 through 7
Foreground Color	default, white, black, red, green, blue, yellow, magenta, cyan
Background Color	default, white, black, red, green, blue, yellow, magenta, cyan
Edge Color	default, white, black, red, green, blue, yellow, magenta, cyan
Foreground Opacity	default, translucent, transparent, flashing, solid
Background Opacity	default, translucent, transparent, flashing, solid
Edge Style	default, none, raised, depressed, uniform, left drop shadow, right drop shadow

Digital Mode Time Setup

The current time will be set automatically from a digital channel signal provided by a broadcasting TV station.

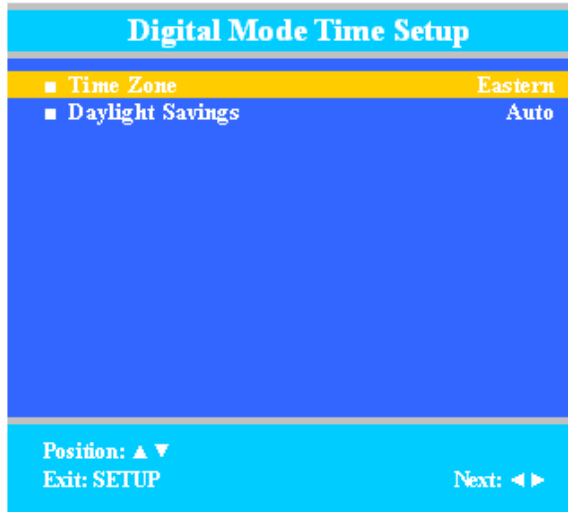

1. Enter the Features menu
2. Press ▲ or ▼ to highlight Digital Mode Time Setup
3. Press ▶ to select it.
4. Press ◀ or ▶ to select your viewing area time zone: Pacific, Alaska, Hawaii, Newfoundland, Atlantic, Eastern, Central or Mountain.
5. Press ▲ or ▼ to highlight Daylight Savings.
6. Press ◀ or ▶ to select Auto, On, or Off depending on whether or not your viewing area observes Daylight Savings Time.
7. Press SETUP to return to the previous menu. To exit, press SETUP until the programming menus disappear.

Diagnostics

This menu provides readouts of the TV's internal operation. The Diagnostics menu items are read-only and can not be changed.



Field ON Hours:	Cumulative time TV is actually on.
Field Powered Hours:	Cumulative time TV is powered.
IO Firmware VSN:	Firmware version of the input and output communication within the TV.
Main Firmware VSN:	Main firmware version

1. Enter the Features menu
2. Press ▲ or ▼ to highlight Diagnostics.
3. Press ▶ to select it.
4. Press the SETUP button to return to the previous menu. To exit, press SETUP until the programming menus disappear.

Channel up Power Off

This feature causes the TV to turn off once it reaches the highest numbered (last) channel and is usually used with single button style pillow speakers. When the feature is disabled, the TV will continue on to the lowest channel and not turn off.

1. Enter the Features menu
2. Press ▲ or ▼ to highlight Channel Up Power Off.
3. Press ◀ or ▶ to select Enabled or Disabled.
4. Press SETUP to return to the previous menu. To exit, press SETUP until the programming menus disappear.

Channel to Other Source

External signal sources connected to the TV, such as DVD players or video-game systems, are shown in the current channel lineup after the highest channel and then shown on the TV. Set this feature to Disabled to require the activation of the external sources by pressing the remote's or the TV's TV/AV button. Set this feature to Enabled to allow access to external devices by pressing channel up or down buttons on a remote or most pillow speakers.

1. Enter the Features menu
2. Press ▲ or ▼ to highlight Channel to Other Source.
3. Press ◀ or ▶ to select Enabled or Disabled.
4. Press SETUP to return to the previous menu. To exit, press SETUP until the programming menus disappear.

NOTE: The source must be enabled before it can be chosen as a power on source. The Last entry causes the TV to power on to the Last source selected.

5. Press SETUP to return to the previous menu. To exit, press SETUP until the programming menus disappear.

FM Radio

You can listen to FM radio stations that are combined with the cable TV signals using this TV.

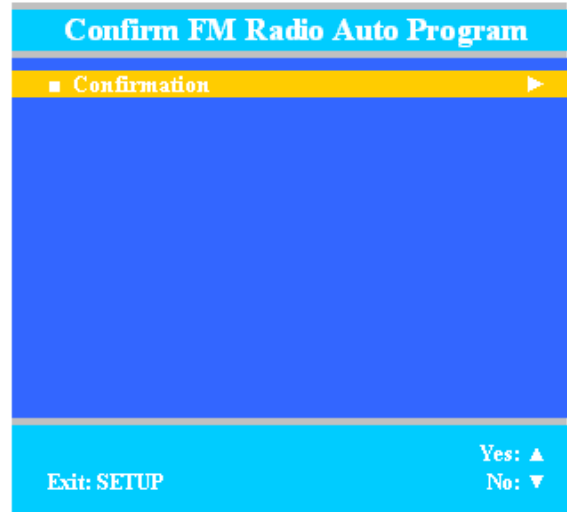
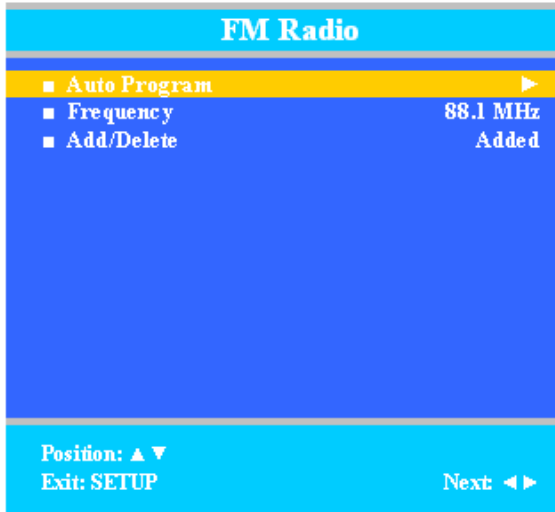

Auto Program

This will search for active radio stations to program into the P19's FM tuner.

1. Press ▲ or ▼ to highlight FM Radio.
2. Press ► to enter it.
3. Press ▲ or ▼ to highlight Auto Program
4. Press ► to select it.
5. A confirmation page will appear. Press ▲ to proceed. Press ▼ or SETUP to return to the previous menu.

Add/Delete Stations

1. Press ▲ or ▼ to highlight Frequency.
2. Press ◀ or ▶ to select the frequency you wish to add or delete.
3. Press ▲ or ▼ to highlight Add/Delete.
4. Press ◀ or ▶ to select Added or Deleted.
NOTE: When you return to the normal viewing screen, a station you deleted will be playing. Press ▲ or ▼ to tune to another station. Now the station is deleted. You cannot go back to it.
5. Press the SETUP button to return to the previous menu. To exit, press SETUP until the programming menus disappear.

Cloning

Cloning allows quick programming of a TV from a SD Card. The operation involves first downloading setup information from a programmed host TV to an SD Card and then uploading the setup information to another TV. Cloning can also be used to re-program a programmed TV.

Save Settings to SD Card

1. There needs to be a TDF file for the P19 in a folder called "PDITDF" on the SD Card before settings can be saved. This file is posted on PDI Communication's web site: <http://www.pdiarm.com/support/>
NOTE: *If the files are not on the SD Card or not in the PDITDF folder, a screen will appear that says there are no files in the PDITDF folder when you perform step 5.*
2. Turn on the TV.
3. Insert the SD Card into the SD slot on the connector panel of the TV. (See connections picture on page 8.) A Cloning Main Menu will appear.
4. Press ▲ or ▼ to highlight Save Settings to SD Card.
5. Press ► to display Save Settings to SD Card.

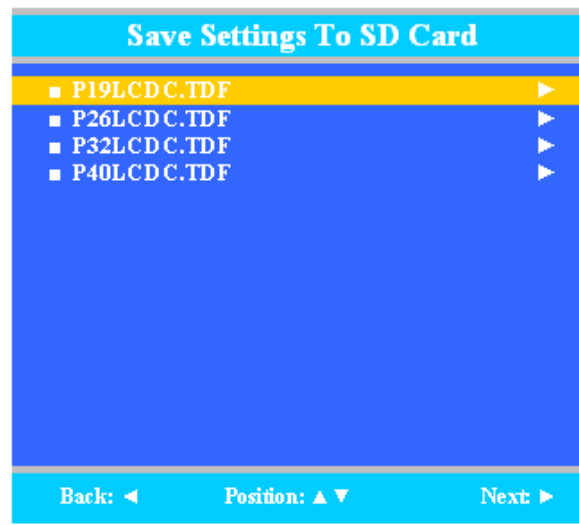
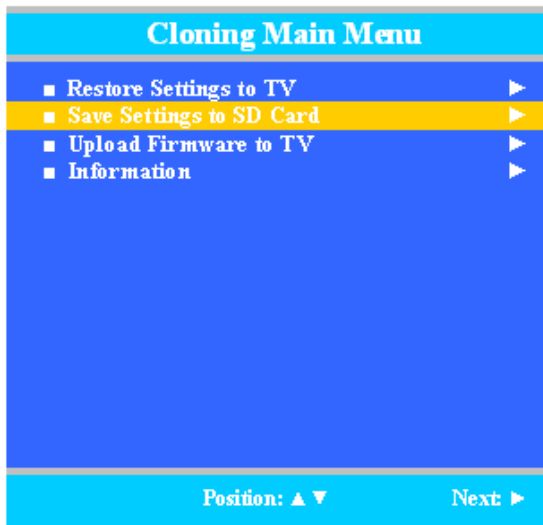

6. Press ▲ or ▼ to highlight the file for the P19.
NOTE: *The file name might be different than what is shown in the above, right screen shot.*
7. Press ► to download the TV's setup to the SD Card. A progress screen will be displayed.

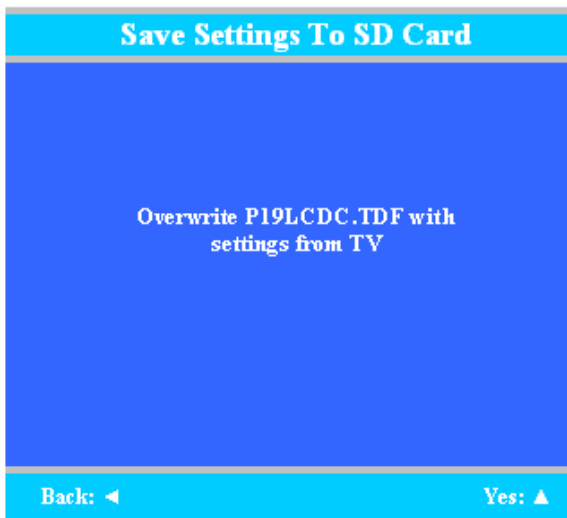

6. A confirmation screen will appear. Press the ▲ to start the process or press ◀ to return to the previous menu.

7. A progress screen will appear as the settings are restored. Press ◀ twice to return to the Cloning Main Menu.
8. Remove the SD card to return to normal TV operation.

Restore Setting to TV



1. Press ▲ or ▼ to highlight Restore Settings to TV.
2. Press ► to display a list of previously stored TV setups on the SD Card.
3. Press ▲ or ▼ to highlight the desired setup file.
4. Press ► to select it.
5. A confirmation screen will appear. Press the ▲ to start the process or press ◀ to return to the previous menu.
6. A progress screen will appear as the settings are restored. Press ◀ twice to return to the Cloning Main Menu.

Information

This is a read-only menu that allows you to check what version of firmware the TV is using.



1. In the Cloning Main Menu, press ▲ or ▼ to highlight Information.
2. Press ▶ to select it.
3. Press ◀ to return to the previous menu.

Firmware

The firmware for the model PDI-P19 TV is field upgradeable. A data file is written to an SD Card, connected to the TV's Cloning port (See page 8), and updated using the TV's menus. Once complete, the TV settings must be reprogrammed.

1. There needs to be a file called config.txt in the PDITDF folder the SD Card before settings can be saved. The file is posted on PDI Communication's web site: <http://www.pdiarm.com/support/>
NOTE: If the file is not on the SD Card or not in the PDITDF folder, a screen will appear that says the file is not in the PDITDF folder when you perform step 4.
2. Insert the SD Card into the cloning port of the P19.
3. When the cloning menu appears, press ▲ or ▼ to highlight Upload Firmware to TV.
4. Press ▶ and an Upload Firmware to TV menu will appear.

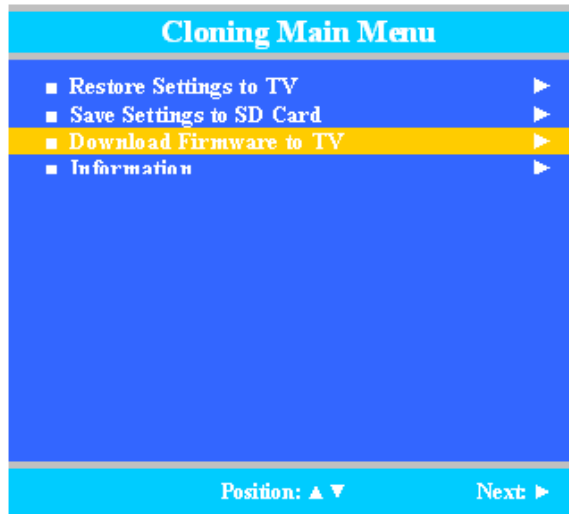

5. Press ▲ or ▼ to highlight Update ATMegal6, Update ZR760, and Update Boot Sector
6. Press ▶ to set each one to 1 or 0. 1 means it will be updated, 0 means it will not.

ATMega16
ZR760
Boot Sector

I/O firmware
Main firmware
Firmware that operates when the power button is pressed

7. Press ▼ to highlight Upgrade
8. Press ► to select it.
9. A confirmation screen appears. Press ▲ to start the updating process. Or press ◀ to return to the previous menu.



10. Another confirmation screen will appear. Wait for the update to start. Or press ▼ to start it immediately.
NOTE: The screen explains what it means when the LED light on the front of the screen flashes, is solid, or is dark. The screen will turn black during the process.



11. If the update is successful the LED light will turn blue. Then the TV will return to the Cloning main menu.
12. Remove the SD Card to return to normal viewing.

DVD Module Operation



WARNING: AC power supply must be disconnected before installing the DVD Player. Failure to do so will cause irreversible damage to the TV.

DVD Module Installation

Refer to the illustration below and follow the procedures below to install the DVD Module onto the LCD TV.

1. Plug the connector into the DVD Module.
2. Carefully slide the module into position and secure the module with one screw.



Enable DVD Module

Now that you have the DVD Module installed, it needs to be enabled by using the programming menus. After the DVD Module is enabled, it is ready for use.

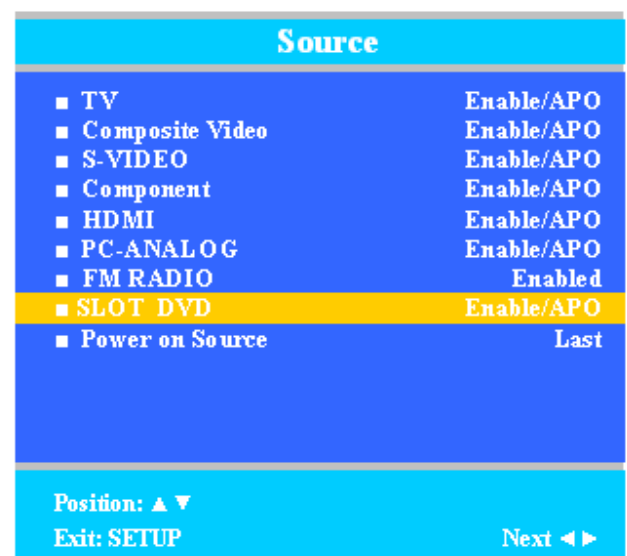

1. Plug the Power Cable into the wall outlet.
2. Turn on the TV.
3. Press SETUP on the programming remote, PD108-420.
4. From the SETUP menu, press ▲ or ▼ to highlight Sources.
5. Press ▶ to select it.
6. Press ▼ to highlight SLOT DVD.
7. Press ◀ or ▶ to change the source status to Enabled/APO.
8. To exit, press SETUP until the programming menus disappear.

DVD Playback

Basic Controls

Patients may use a compatible pillow speaker or a Patient remote (PD108-427).

NOTE: Some pillow speakers may not have all the DVD control functions that are listed below. (Consult pillow speaker manual.)

- Use the **TV/AV** button on the TV or remote to select SLOT DVD mode.
- Gently insert the disc into the slot, with the label side facing the same direction as the front of the TV.
- The disc will be drawn into the unit and loaded automatically.

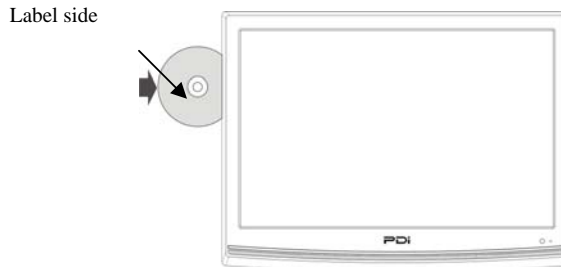

- Press the **▶ Play** button to start playback.
NOTE: Playback might start automatically when the disc is inserted.
- During playback, press the **■ Stop** button once to stop playback and then press **▶ Play** button to resume. Press **■ Stop** button twice to cancel Last Memory (Last Memory remembers the last place stopped on a disc, so it can be returned to by pressing Play.)
- During playback, press the **⏸ Pause** button once to pause the playback; press it repeatedly to start step-by-step playback and then press the **▶ Play** button to resume normal playback.
- During playback, press the **⏭** button to go to the next chapter. Press the **⏮** button once to return to the beginning of the current chapter; press it twice to go to the previous chapter.
- With the Patient remote, use the number buttons to enter a desired chapter.
- During playback, press the **⏭** button to activate fast forward playback; press the **⏮** button to activate fast backward playback. During fast playback, press the **▶ Play** button to resume normal playback.
NOTE: The FFD/RWD speeds are x2, x4, x8, x16, x32.
- Press the **MUTE** button to turn the sound on and off.
- **VOL +/-** to control the volume level.

Navigating menus

On the PD108-427 remote, the OK button and the directional buttons that surround it can be used to select the menu item choices on a DVD. (e.g. Scene Selection and Bonus Features.). Use the four directional buttons to move to the desired menu item, and press the OK button to select it.

Advanced DVD playback features

Besides the basic controls for playing, pausing, rewinding, and advancing through a DVD, there are other functions that can be performed during playback.

Repeating a Chapter or Title

1. Press the **REPEAT** button, at the bottom of the remote, to cycle through the selections: Title, Chapter, or All.
2. Stop pressing **REPEAT** when the desired selection appears on screen.

Changing the Subtitle and Audio

Many DVDs have the ability for their content to be played back in various languages or other types of audio outputs. They also have the ability to display subtitles in various languages.

Audio

1. To set the audio to a certain type of language, types of audio output, or commentary, press the **AUDIO** button to cycle through the choices.
2. Stop pressing **AUDIO** when the desired selection appears on screen.

Subtitle

1. To set a Subtitle in a certain language, press the **SUBTITLE** button to cycle through the choices.
2. Stop pressing **SUBTITLE** when the desired selection appears on screen.

DVD Content Information

While the DVD is playing, you can view different types of information about the content, such as what chapter is being played or what subtitle is set. The table below shows different categories of information and what can be changed.

1. Press GOTO, at the bottom of the Patient remote.
2. Press ▲ or ▼ to highlight the desired category
3. Press OK to select the category.
4. If there is a number to be entered, use the number buttons.
 - NOTE:** Once a digit is entered, the next digit will be ready to be entered. The directional buttons WILL NOT work. If it is a list of choices, do the following.
 - a. Press ▲ or ▼ to highlight the desired choice.
 - b. Press OK to select the category.
5. Press GOTO to return to normal viewing.

Category	Options
Title	Displays the current title. This can be changed if the DVD has multiple titles and it allows you to change them.
Chapter	Displays the current chapter. This can be changed if the DVD has multiple chapters and it allows you to change them.
Audio	Displays the current audio setting. This can be changed to another available language or audio output.
Subtitle	Displays the current subtitle setting. This can be changed to another available subtitle.
Angle	Some DVDs have scenes where multiple angles have been recorded. You can change the angle of a scene.
TT Time	This shows the length of the playing title. You can enter a time in the video, and the disc will go to that time.
CH Time	This shows the length of the playing chapter. You can enter a time in the chapter, and the disc will go to that chapter and time.
Repeat	Chapter, Title, All, Off
Time Display	Title Elapsed, Title Remain, Chapter Elapsed, Chapter Remain

Setup menu

Like the TV, the DVD module has a Setup screen that allows you to set various features. (See the table on page 44 for a description of the menus and what categories and settings they contain.)



1. Press SETUP.
2. Press ◀ or ▶ to highlight the desired Setup Page.
3. Press OK to select it.
4. Press ▲ or ▼ to highlight the desired category selection.
5. Press OK to select it.
6. Press ▲ or ▼ to highlight the desired option.
7. Press OK to select it.
NOTE: Some options may take you to an adjustable meter. Use the directional buttons to adjust the meter.
8. If you are done, go to next step. If not, press ◀ to back out of each selection.
9. Press SETUP to return to normal viewing.

Menu sections	Categories	Options	Options (continued)	Description
General Setup Page	TV Display (when DVD is not inserted)	4:3/Pb, 4:3/Lb, 16:9, Wide squeeze		Adjusts the aspect ratio of the image or video.
	Angle	On, Off		Allows for other angles of a scene in a video to be viewed (if other angles have been recorded on the DVD)
	OSD Lang	English, French, Spanish, German, Italian		Changes the languages of the Setup menus
	Captions	On Off		Turns captions ON or OFF
	Screen Saver	On Off		Turns screensaver ON or OFF
	Last Memory	On Off		When set to ON, the module will start to play the disc where it was last stopped.
Audio Setup Page	Dolby Digital Setup	Dual Mono	Stereo, L-Mono, R-Mono, Mix-Mono	Dual Mode and Dynamic allow the difference between high and low sounds to be adjusted for each of the four settings: Stereo, L-Mono, R-Mono, and Mix-Mono
		Dynamic	Meter. Use ▲ and ▼ buttons to adjust	
	HDCD	Off 1x 2x		A filter can be set for HDCDs
Video Setup Page	Quality	Sharpness, Brightness, Contrast		Adjust 3 setting meters: -20 to 20
Preference Page (w/o DVD inserted)	Audio	English, French, Spanish, German, Italian, Japanese, Russian, Chinese		Change the language spoken on a video(if the DVD offers the language)
	Subtitle	French, Spanish, German, Italian, Japanese, Russian, Chinese, Off		Set the language in which subtitles will be displayed(if the DVD offers the language)
	Disc Menu	English, French, Spanish, German, Italian, Japanese, Russian, Chinese		Changes the languages of menus of the DVD menus(if the DVD offers the language)
	Parental	Kids Saf, G, PG, PG-13, PGR, R, NC-17, Adult		The password will be required if an inserted movie is at a level that is equal to or higher than what is set.
	Default	Reset		Resets module to factory settings
Password Setup Page	Password Mode	On, Off		If set to On, the password will be required to change the Parental options or watch a movie that is at a rating level equal to or higher than what is set in the Parental category.
	Password	Change		Allows for a new password to be set
Exit Setup Menu				Close Setup menu

CD Playback

Basic Controls

1. If the SLOT DVD source is not already displayed, press the **TV/AV** button on the TV or remote until it is displayed.
2. Gently insert the disc into the slot, with the label side facing the same direction as the front of the TV.
3. The disc will be drawn into the unit and loaded automatically.

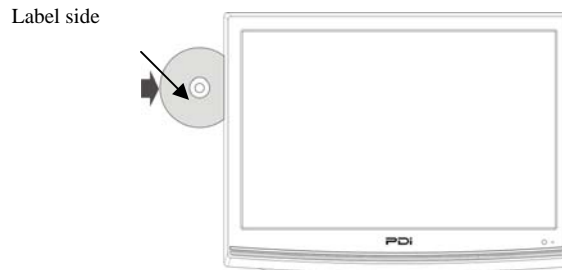

4. Press the **▶ Play** button to start playback.
NOTE: Playback might start automatically with Track 1 when the disc is first inserted.
5. During playback, press the **■ Stop** button once to stop playback and then press **▶ Play** button to resume.
6. During playback, press the **⏸ Pause** button once to pause the playback; press it repeatedly to start step-by-step playback and press the **▶ Play** button to resume normal playback.
7. During playback, press the **⏭** button to go to the next track. Press the **⏮** button once to return to the beginning of the current track; press it twice to go to the previous track.
8. The number buttons also can be used to enter track numbers.
9. During playback, press the **⏩** button to activate fast forward playback; press the **⏪** button to activate fast backward playback. During fast playback, press the **▶ Play** button to resume normal playback.
NOTE: The FFD/RWD speeds are x2, x4, x8, x16, x32.
10. Press the MUTE button to turn the sound on and off.
11. VOL +/- to control the volume level.

Advanced CD playback features

Besides the basic controls for playing, pausing, rewinding, and advancing through a CD, there are other functions that can be performed during playback.

Setting a track or whole CD to loop

1. Press the REPEAT button, at the bottom of the remote, to cycle through the selections: Track or All.
2. Stop pressing REPEAT when the desired selection appears on screen.

Skipping to a certain place on a CD

1. Press the GOTO button, at the bottom of the remote, to cycle through the selections: Disc Go To, Track Go To, or Select Track.
2. Stop pressing GOTO when the desired selection appears on screen.
3. Use the number buttons to enter the desired time or track.

NOTE: Once a digit is entered, the next digit will be ready to be entered. There directional buttons WILL NOT work.

Adjusting Audio output

The audio output can be set four ways: stereo, mono left, mono right, or mix-mono

1. Press the AUDIO button, at the bottom of the remote, to cycle through the selections.
2. Stop pressing AUDIO when the desired selection appears on screen.

Viewing JPG photos on a USB drive, SD card, or CD

Access USB/SD Card

1. Insert SD card or USB into corresponding slots
2. Press CARD to Display menu
3. Press ▼ to highlight Media
4. Press ► to select it.
5. Press ▼ or ▲ to highlight SLOT 1 USB or SD
NOTE: If one is inserted only one will appear.
6. Press OK

Access Photo CD

1. Press CARD to Display menu
2. Press ► to select Media
3. Press OK

View JPEG

1. Press ▼ or ▲ to highlight to highlight desired picture or folder
2. Press OK to select picture. Press OK or ► to access a folder.
NOTE: It may take a minute for pictures to show full screen.
3. Press MENU to return to the selection window.

Control Slide Show

1. Basic controls
 - a. >>| button. Forward to next picture
 - b. |<< button. Go back to previous picture
 - c. Pause. The displayed picture remains on screen. Slide show halts.
2. Rotate pictures. Use the directional buttons to rotate a picture.
 - a. ▲ = upside down. Press this button again to return picture to normal position
 - b. ▼ = turn around. Press this button again to return picture to normal position
 - c. ► = clockwise
 - d. ◀ = counter-clockwise
3. Change how the slide show cycles through pictures
Press REPEAT button again and again to cycle through Shuffle, Repeat All, Random, Repeat One, and Single

Selecting Thumbnail Photos

You can stop the slide show and select an individual photo by entering a thumbnail screen

1. While slide show is playing, press STOP access a thumbnail menu
2. Press ◀ or ► to highlight thumbnail photo
3. Press OK to select it

Selecting More Thumbnails

If there are many photos stored in the file you are viewing, not all the thumbnails for them will appear at the same time. Use the following steps to view more of them.

1. Press ▼ to access bottom menu items
2. Press ◀ or ► to highlight Prev. or Next
 - a. Prev. – previous set of thumbnails
 - b. Next – next set of thumbnails
3. Press OK to select it

Other Thumbnail Screen Controls

1. Press ▼ to access lower menu items
2. Press ◀ or ► to highlight Slide Show or Menu
 - a. Slide Show – return to slide show
 - b. Menu – read-only menu with instructions for basic controls
3. Press OK to select it

Limited Warranty

PDI Communication Systems Inc., ("PDI") warrants, to the original purchaser only, that the PDI-P19 will be free from defects in materials and workmanship, under normal use, for 2 years from the date of original purchase. This warranty does not cover any other equipment that may have been included with PDI's shipment of this product.

After receipt of written notice of a defect or malfunction occurring during the warranty period, PDI will repair or replace goods returned to its Springboro, Ohio location, at its discretion, free of charge to the original purchaser, the whole or any component part of any product manufactured by PDI and found by PDI to be defective.

As a condition to obtaining warranty service, written notification must be received by PDI within at least ten (10) days after defect is first observed. Repair of said product requires it to be shipped to the PDI factory in Springboro, Ohio. All shipments shall be F.O.B. Springboro, Ohio, and all shipping and freight charges to PDI's factory shall be paid by the customer.

This warranty shall not apply to any PDI products subjected to improper use, negligence or accident; nor to tampering, alterations, or repairs by others, without PDI's specific prior written authorization. For information regarding authorized servicing and all other information pertaining to this warranty, please contact PDI COMMUNICATION SYSTEMS, Inc. at 40 Greenwood Lane, Springboro, Ohio 45066 or phone 937-743-6010.

This warranty gives specific legal rights and you may also have other rights which vary from state to state.

PDI's liability under this warranty is limited to repair or replacement of defective products and parts as provided above. PDI shall not be liable for incidental or consequential damages.*

The warranty contained herein is in lieu of all other expressed or implied warranties, including any implied warranty of merchantability or fitness for any particular purpose. PDI neither assumes nor authorizes any person to assume, on its behalf, any other obligation or liability.

*Some states DO NOT allow the exclusion of limitation of incidental or consequential damages or a disclaimer of warranties implied by law, so the above limitation or exclusion may not apply.

The information and technical data in this manual is believed accurate, but is not warranted and is subject to change without notice or obligation.

"PDI" and "Better Solutions Are Within Reach" are registered trademarks of PDI Communication Systems, Inc.

Copyright © 2004-2009 by PDI Communication Systems, Inc.

All rights reserved